

# ***JM-Jaw registration systems***

## **Specifications and Operating Instructions**

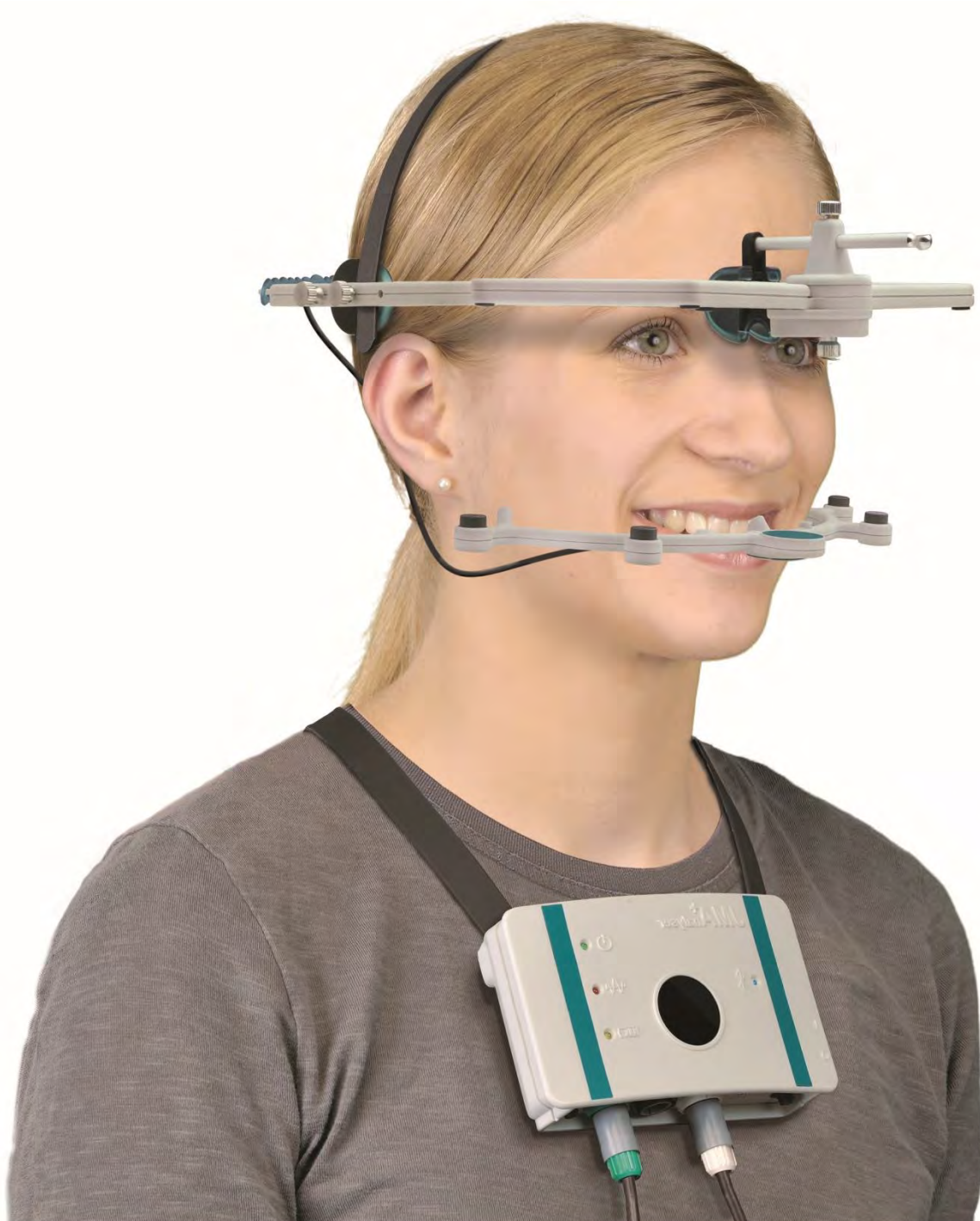

# CONTENT

<b>1</b>	<b>INTRODUCTION</b>	<b>3</b>
1.1	MANUFACTURER INFORMATION	3
1.2	LAYOUT OF THE USER MANUAL	4
1.3	CONVENTIONS AND SYMBOLS USED	5
<b>2</b>	<b>AREA OF USE AND SAFETY</b>	<b>6</b>
2.1	INTENDED USE	6
2.1.1	USE	6
2.1.2	ARTICULATORS	7
2.1.3	DATA EXPORT	7
2.2	SAFETY	8
2.2.1	ENVIRONMENTAL CONDITIONS	8
2.2.2	STORAGE AND TRANSPORT	8
2.2.3	OBLIGATIONS OF THE USER	9
2.2.4	GENERAL SAFETY INFORMATION	10
2.2.5	SAFETY INFORMATION ON HEART PACEMAKERS/DEFIBRILLATORS	11
2.2.6	PROHIBITED USE	11
<b>3</b>	<b>PRODUCT DESCRIPTION</b>	<b>12</b>
3.1	SYSTEM COMPONENTS	12
3.2	TECHNICAL DATA OF THE JMANALYSER MEASUREMENT SYSTEM	12
3.3	MEASURING PRINCIPLE	13
3.4	CONTROL ELEMENTS AND CONNECTORS JMANALYSER+ BT	14
3.5	CONTROL ELEMENTS AND CONNECTORS JMT+	15
3.6	MEANING OF THE DISPLAY LIGHTS	16
3.7	ASSIGNMENT OF THE CONNECTING SOCKETS	17
3.8	DIGITAL INPUTS	18
3.9	EMG FOR THE DETERMINATION OF THE MUSCLE TONE OF THE JAW MUSCLES	18
3.10	ACTIVE DIFFERENTIAL ELECTRODE CABLE	19
3.11	ACCESSORIES AND SPARE PARTS	20
<b>4</b>	<b>PUTTING THE MEASUREMENT SYSTEM INTO OPERATION</b>	<b>26</b>
4.1	POWER SUPPLY & CHARGING THE BATTERY (JMANALYSER+ BT AND JMT+)	26
4.2	IT SECURITY AND SOFTWARE INSTALLATION	27
4.3	CONNECTING THE ACCESSORY PARTS	29
4.4	CONNECTION OF THE BASIC UNIT VIA USB INTERFACE	30
4.5	CONNECTION OF THE BASIC UNIT VIA BLUETOOTH INTERFACE	31
4.5.1	BLUETOOTH CONNECTION VIA AUTOMATIC BLUETOOTH DEVICE DETECTION	31
4.6	TAKING THE MEASUREMENT SYSTEM OUT OF OPERATION	32
<b>5</b>	<b>CONTROL MEASURES, PREPARATION, DISPOSAL</b>	<b>33</b>
5.1	MANDATORY PERIODIC INSPECTIONS AND STK	33
5.2	CHECKING THE MEASUREMENT FUNCTION	34
5.3	TROUBLESHOOTING	35
5.4	PREPARATION METHODS	36
5.4.1	MANUAL DISINFECTION	36
5.4.2	MANUAL CLEANING	37
5.4.3	STERILIZATION	37
5.5	DISPOSAL	38
5.5.1	PACKAGING	38
5.5.2	DISPOSAL OF ELECTRONICS	38
5.5.3	ACCUMULATORS AND BATTERIES	38
<b>6</b>	<b>SAFETY STANDARDS AND SYSTEM CLASSIFICATION</b>	<b>39</b>
6.1	CLASSIFICATION ACC. TO ANNEX IX OF DIRECTIVE 93/42/EEC	39
6.2	SAFETY OF MEDICAL ELECTRICAL DEVICES	39
6.2.1	CONNECTING THE JM MEASUREMENT - SYSTEM TO OTHER ELECTRICAL DEVICES	39
6.2.2	VICINITY OF THE PATIENT / TEST PERSON	40
6.2.3	MULTIPLE SOCKETS	41
6.3	ELECTROMAGNETIC COMPATIBILITY GUIDELINE & MANUFACTURER DECLARATION	42

# 1 Introduction

© 2019 zebris Medical GmbH

All rights reserved. Reproduction in whole or in part only with the express permission of zebris Medical GmbH.

Illustrations of this manual may differ.

## 1.1 Manufacturer Information



# Manufacturer

<b>zebris Medical GmbH</b>	Phone	+49 (0)7562 9726 - 0
Am Galgenbühl 14	Fax	+49 (0)7562 9726 - 50
88316 Isny im Allgäu	E-Mail	<a href="mailto:info@zebris.de">info@zebris.de</a>
Germany	Web	<a href="http://www.zebris.de">www.zebris.de</a>

## Sales / Support

<b>zebris Medical GmbH</b>	Phone	+49 (0)7562 9726 - 300
Am Galgenbühl 14	Fax	+49 (0)7562 9726 - 50
88316 Isny im Allgäu	E-Mail	<a href="mailto:support@zebris.de">support@zebris.de</a>
Germany	Web	<a href="http://www.zebris.de">www.zebris.de</a>



Please always provide the serial number of the product for inquiries!

## 1.2 Layout of the user manual

The user manual of the JM-Jaw registration systems consists of several parts:

1. JM-Systems Technical Data and Operating Instructions
2. zebris WINJAW+ user manual of the application software

The part KM-Systems Technical Data and Operating Instructions primarily contains information on technical data and operation of the JM measuring system, as well as information on its safe operation in combination with patient accessories such as a bite fork or infrared foot switch.

Notes regarding the accessories are limited to essential safety and maintenance measures and hygiene procedures.

The software and hardware operating instructions can be displayed in the software as online help (F1 key).

In addition, the documents are available on the enclosed installation data carrier and on-line at <https://www.zebris.de/infomenue/downloads/>



**WARNING**

Read these instructions carefully before using the product for the first time to avoid operating errors and damage.

The exact adherence to all part of the operating Instructions for the measuring system is a precondition for its intended use.

## 1.3 Conventions and Symbols Used



The green markings in the margin of the User Manual denote new information about the product safety.



“**WARNING**” symbols indicate a potential hazard to the health and safety of the users and/or patients. The warnings describe the risks involved and those can be avoided.



“**NOTE**” symbols indicate a potential risk which could lead to damaging of the device. These NOTE symbols describe the risks involved and how those can be avoided.



CE mark according to EC directive 93/42 Medical devices



Manufacturer



Manufacturing Date



Device of type BF according to DIN EN 60601-1



Direct Current



USB-Interface



Do not dispose of with household waste



High frequency transmitter (Bluetooth Interface)



Item Number



Serial Number



Medical Device



An accessory that is intended for one-off use on a single patient during a single treatment.



Refer to instructions for use.

## 2 Area of use and safety

### 2.1 Intended Use

The zebris JM-measuring systems calculates from the recorded jaw movements of the patient all the necessary parameters with the objective of designing a functional prosthesis and splints. The measuring system also allows the output of functional parameters for the programming of virtual and mechanical articulators and export of data for further processing with CAD/CAM or DVT systems.

Furthermore, the system allows the therapeutic positioning of the mandible in a jaw relation.

The measuring system must only be used by trained dentists.

The application environment is limited to dental facilities.

A measurement is performed within 15 minutes, and should not be used on open wounds in the oral and head area, where it may be used in patients of any age who are able to mentally follow the operator instructions exactly.

#### 2.1.1 Use

zebris JM-measuring systems are electronic registration systems that are based on 3D ultrasound measurements. zebris JM-measuring systems capture the individual mandibular movements of patients in all degrees of freedom which are necessary for the production of functional dentures and splints.

The 3D representation of the positions and movement traces occlusal or joint near measurement points are particularly important information on the movement behavior of the temporomandibular joint and the lower or upper jaw teeth. The 3D representation of prominent positions in the face is a classification of the symmetry of the face to prepare the denture.

In a preliminary functional assessment discoordination's and movement limitations can be analyzed and documented. The system is able to determine a neuromuscular jaw relation in the situation.

The electronic position analysis of the condyles allows the comparison of different occlusal positions and can thus give indications of possible pain vectors in the joint.

By means of a separate software module, an analysis of chewing movements can be realized.

The system determines the adjustment of fully adjustable virtual or mechanical articulators.

In conjunction with the optional 2 or 4 analog channels integrated in the JMAlyser + BT devices, the zebris JM product family allows the analysis and functional tests of various muscle groups, such as the temporalis anterior and masseter.

The XML export function allows the use of the determined jaw movements in CAD/CAM systems and CBCT systems for functional optimization of dental restorations and occlusal splints.

The zebris JM-measuring systems are used to support the functional diagnosis. The measuring sensor consists of a receiver and a transmitter. It is attached to the patient's head. The lower jaw sensor is equipped with a special locking mechanism for the attachment. The face bow is put forward by means of support on the nasion and applied to the back of the head above the ears. A measurement can then be carried out, according to the desired settings and measured parameters on the software.

All measuring and analytical results of the zebris JM-measuring systems should always be interpreted in the light of the clinical history of the patient and in the context of other diagnostically methods of a demonstrably trained person and examined for relevance. If invasive measures are taken, the measurement system should only be used as an additional assessment method. Under no circumstances can or should invasive surgery or measures that put the patient at risk be carried out based on the measurement result alone

### **2.1.2 Articulators**

With the help of the zebris JM-measuring systems is it possible to adjust the following articulators:

- Artex AR (Girrbach/Amann)
- KaVo PROTAR 7
- SAM
- Stratos 300 (Ivoclar)

### **2.1.3 Data Export**

The XML export function allows the use of determined jaw movements in CAD/CAM systems and CBCT systems for functional optimization of dental restorations and occlusal splints. As a reference for data matching serves a bite fork. This bears reference marks which of imaging systems such as Surface scanner or DVT can be detected.

## 2.2 Safety

### 2.2.1 Environmental conditions

The JM-measuring systems are suitable for use in dry interior rooms, as can be found in clinics, medical practices and laboratories.

Temperature	10°C to 40°C
Air pressure	700 to 1100 hPa
Relative humidity	30% to 70%, non condensing



The Jaw motion systems must NOT be operated in wet zones, wet rooms (swimming pools, saunas) or climatic chambers.

The measuring systems are not intended for operation in potentially explosive atmospheres of medically used rooms or oxygen-enriched atmospheres.

The devices must not be operated in proximity to e.g. engines or transformers with a high connected load as well as mains current lines, as electrical or magnetic interference fields can falsify correct measurements resp. turn them impossible.

To avoid reciprocal faults from occurring, two JM-measuring systems should never be operated in the same room or near other ultrasound emitting devices (e.g. ultrasonic cleaners, bird scare devices, alarm systems), as this can cause the measured values to be falsified.

### 2.2.2 Storage and Transport

Storage and transport of the measuring system are only to be effected in the original packaging provided by zebris.

Temperature	-20°C to +70°C
Relative humidity	max. 95%, non condensing
Protect from moisture	



### 2.2.3 Obligations of the user



- The general guidelines and/or national legislation, national regulations and technical regulations pertaining to medical products are to be applied and fulfilled both with the start-up and during the operation of the zebris product appropriate to the stated purpose. In Germany, operators, those responsible for such devices, and users are obliged to operate their devices in compliance with the MPG (Medical Devices Act) regulations.
- It is the obligation of the user:
  - ✓ To comply with all the safety instructions stated in the operating instructions.
  - ✓ To carry out all of the inspection and maintenance work regularly as specified in the operating instructions
  - ✓ To only use fault free working equipment.
  - ✓ To ensure all the provided operating instructions that from part of the measurement system, are accessible to all users at all time, and to keep them near the measurement system.
  - ✓ To ensure that the device is functionally safe and in a proper state prior to every instance of use of the device.
  - ✓ To protect oneself, the patients and third parties against dangers.
  - ✓ To prevent a contamination occurring due to the product
- During use, it is necessary to comply with the legal regulations especially:
  - ✓ The current work safety regulations.
  - ✓ The current accident prevention measures.
- Responsibility is assumed to ensure the safety, reliability and effective performance of all measurement systems and accessories delivered by zebris, such that:
  - ✓ Assembly work, extensions, new setting, changes or repairs are carried out by zebris authorized, trained technicians or by personnel of authorized dealers. The storage and transport should only be carried out in the original packaging, as provided by the manufacturer.
  - ✓ The product operated in compliance with the operating instructions.
  - ✓ The information technology components provided by the operator comply with the technical requirements for hardware and software contained in these operating instructions, and that they are installed and set up according to the applicable descriptions for these components.
  - ✓ The place of installation corresponds with the specified environmental conditions for the measurement system and the current installation regulations.
  - ✓ Only the software made available by zebris, as well as the components and accessory parts listed in these operating instructions are used with the system.

## 2.2.4 General safety Information



- The use and operation of the system and the evaluation of measurement data and its interpretation should only be carried out by trained specialist personnel. The manufacturer assumes no liability for damage to persons or property, or the loss of data that may occur due to the improper use of the software, the device, or its accessory parts.
- Patients and measurement data may only be copied, moved or deleted with the help of the database function that is provided by the zebris software application. In the case of the deliberate changing of data without the database function, the user alone bears the full risk.
- Measurement and analysis results should always be interpreted in the light of the clinical history of the patient and in the context of other diagnostic tests by a trained person proven and tested for their relevance. Should any measures for treatment be taken on the basis of the measuring results, the measuring system may only be implemented as a supplementary means for evaluation by an expert. On no account can, or may invasive measures, or measures endangering the patient be carried out solely on the basis of the measuring results without further verification of the measuring data by additional methods.
- In the case of malfunctions and/or defects being suspected and/or ascertained, the device has to be taken out of use immediately, labeled as 'Out of Use', and secured to prevent use. The manufacturer or authorized sales partner must always be contacted in all cases of fault or doubt.
- The measuring system must be checked at regular intervals to make sure it is functioning properly. More details on this can be found in the section, "Maintenance of the Device" in this User Manual.
- Do not install the jaw motion analysis system near a source of heat or in direct sunlight behind a window, as excessive heating can lead to incorrect measurement results.
- Be sure that all the mains and connection cables are laid safely and that they are protected against stepping on, so that nobody can trip over them. Check all the cables and the connection plug regularly for any damage. Damaged power Supply's and cables have to be replaced before further operation.
- The measurement system is not protected against the penetration of fluids. If fluid penetrates the measurement system, switch it off and please contact the zebris Medical GmbH technical service team.
- The use of EMG analogue channels at the same time as a high-frequency surgery device can lead to burns of the skin parts under the electrodes or possibly damage the input amplifiers of the JMAlyser+ BT systems.
- The operation of a short wave or microwave therapy device near the JM system may lead to a falsification of the measurement results and should therefore be avoided.
- Before starting every measurement, it is necessary to ensure the correct choice and correct position of the transmitters or application aids. The cables or the application aids (e.g. Pointer) can present a risk of injury to the patient. In this context, please consult the special instructions in the user manual of the application software, and do not allow children or mentally impaired patients to enter the proximity of the device without supervision.

## 2.2.5 Safety information on heart pacemakers/defibrillators



- In the magnetic coupling for the attachment of the lower jaw sensor on the T-attachment there are strong permanent magnets, such as those that are used on headphones on MP3 players. Under especially unfavorable circumstances, at short distances (<15 cm), these magnets can have a negative impact on the functionality of certain implanted heart pacemakers and defibrillators. Therefore, the lower Jaw - sensor should not be positioned on the upper body of the patient on patients with electronic implants.
- Version BT devices contain a Bluetooth transmitter as an interface to the PC. Although there is so far no evidence of a possible interference of heart pacemakers / defibrillators by Bluetooth transmitters, the JM-measuring systems are not recommended to be used **on patients with electronic implants using the neck strap, but with the maintaining of a safety distance of at least 15 cm from the patients thorax.**
- No interference of electronic implants is to be expected from the ultrasonic transmitters used in the measurement system, as the JM-measurement systems work with airborne sound and very low sound power of a few millimeters. Due to the adverse connection during the transition from the air into the human body, the noise intensity of the measurement signals is weakened strongly such that any interference with implants, as well as any damage to issue, is excluded.

## 2.2.6 Prohibited Use



- Improper and/or prohibited use of the measurement system is not permitted an express warning is herewith provided of such.
- Do not under any circumstances attempt to maintain or prepare the measurement system in any way other than as described in the operating instructions. This could cause the high sensitivity sensor technology to be in impaired terms of its measurement accuracy
- In the case of malfunctions and/or defects being suspected and/or ascertained, the device has to be taken out of use immediately, labeled as ‚Out of Use‘, and secured to prevent use, with the on/off switch being covered and secured with adhesive tape.
- Changing or modifying the measurement system or its accessory parts without the written permission of zebris Medical is not allowed. If the device is changed without permission, the operator is obliged to carry out suitable examinations and inspections in order to guarantee the secure use.
- zebris measurement systems must not be operated in environmental conditions other than those stated in the ‚technical data‘ chapter (e.g. in an oxygen enriched environment, wet zones, damp rooms, climatic chambers, low pressure-,high pressure-, or altitude chambers, etc.).

## 3 Product description

### 3.1 System components

In its basic configuration a JM-measuring system consists of the following components:

- JM-system basic unit (JMAlyser+ or JMT<sup>+</sup>)
- Lower jaw sensor (Transmitter)
- Head bow (Receiver)
- USB charger for supplying the measurement system for BT devices
- 01860420 USB cable adapter
- zebris WINJAW+ application software
- Accessories (IR-remote control, pointer, Attachments)
- User Manual for system and software, equipment and application software

### 3.2 Technical data of the JMAlyser measurement system

Version	JMAlyser+ BT	JMT <sup>+</sup>
REF	01160011	01160020
Dimensions (W x H x D)	145 x 85 x 35 mm	111 x 86 x 31 mm
Weight	232 g	188 g
Power supply	5V DC / 1W (USB to charge battery)	5V DC / 1W (USB to charge battery)
Battery	yes	yes
Measurement range	10 – 100 mm	10 – 100 mm
Ultrasonic frequency	40 kHz	40 kHz
Max. measurement rate	50 Hz	50 Hz
Positioning accuracy in the occlusal area	± 0,1 mm (y); ± 0,2 mm (x, z) ROM 15 mm	± 0,1 mm (y); ± 0,2 mm (x, z) ROM 15 mm
accuracy articulator angles	± 2,0°	± 2,0°
USB-Interface	USB mini, USB Standard	USB
Bluetooth	yes	yes
analog connectors	No / optional with 2 or 4 analog connectors	no
analog measurement area	-2..+2V / resolution of 10 Bit.	N/A.
analog measurement rate	1000/s per channel	N/A.
Measurement accuracy	± 5% of the input value	N/A

### 3.3 Measuring principle

The jaw registration system includes the lower jaw sensor and the ultrasonic receiver module at the head bow as well as a foot pedal or an infra-red remote control. The sensory components of the receiver and transmitter modules are mounted in each geometrically defined position. The markers consist of small ultrasonic transmitters which are operated sequentially. The corresponding head bow contains eight ultrasonic microphones. Both modules are connected via a cable to the transmitter in the JM-measuring system.

In operation, the ultrasonic transmitters provide continuous pulses. From the ultrasonic transit time between the transmitter and receiver microphones, the system calculates by means of an evaluation of a geometry triangulation method, the absolute coordinates of the marker.

The calculation of the measured coordinates and other measurement parameters and the compensation of disturbances are supported by a PC in the evaluation programs.

#### Block diagram of the measurement system JManalyser+ BT

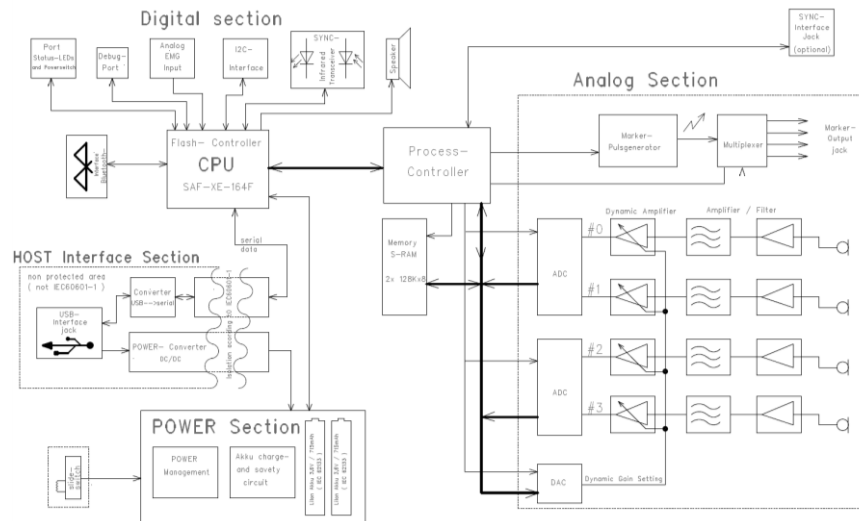

#### Block diagram of the measurement system JMT+

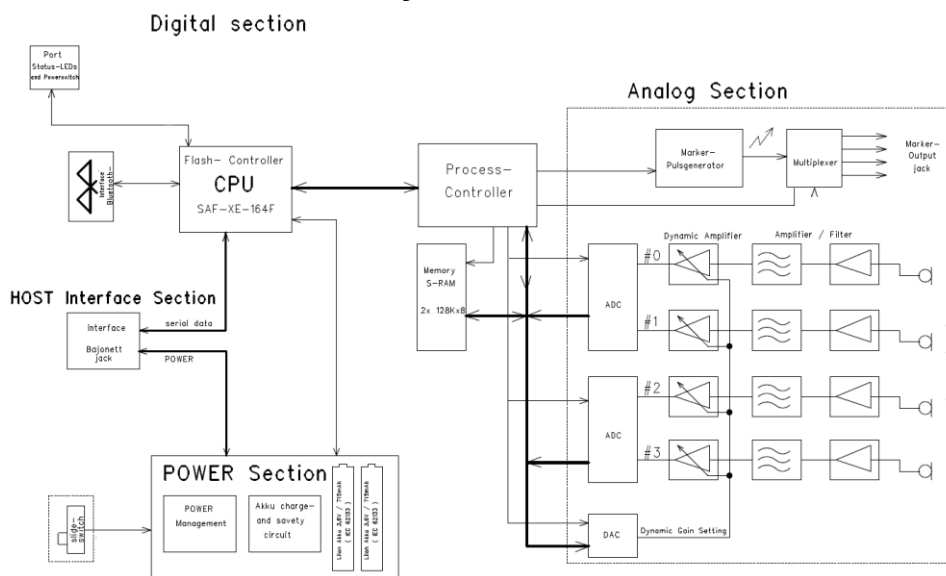

### 3.4 Control elements and Connectors JMAlyser+ BT

analog channels right, only available with optional extension of 2 or 4 analog channels

analog channels left, only available with optional extension of 2 or 4 analog channels

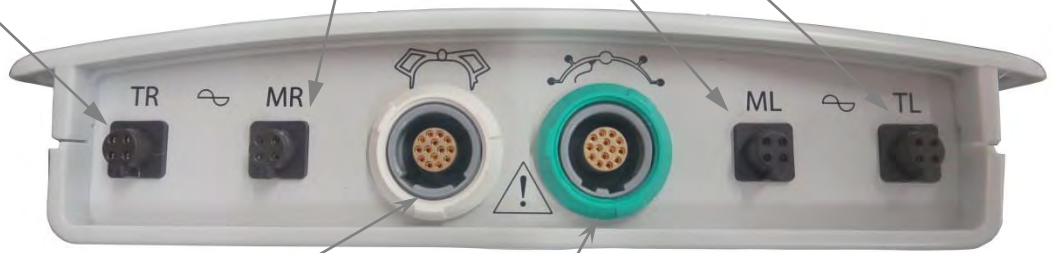

Head bow

Lower jaw

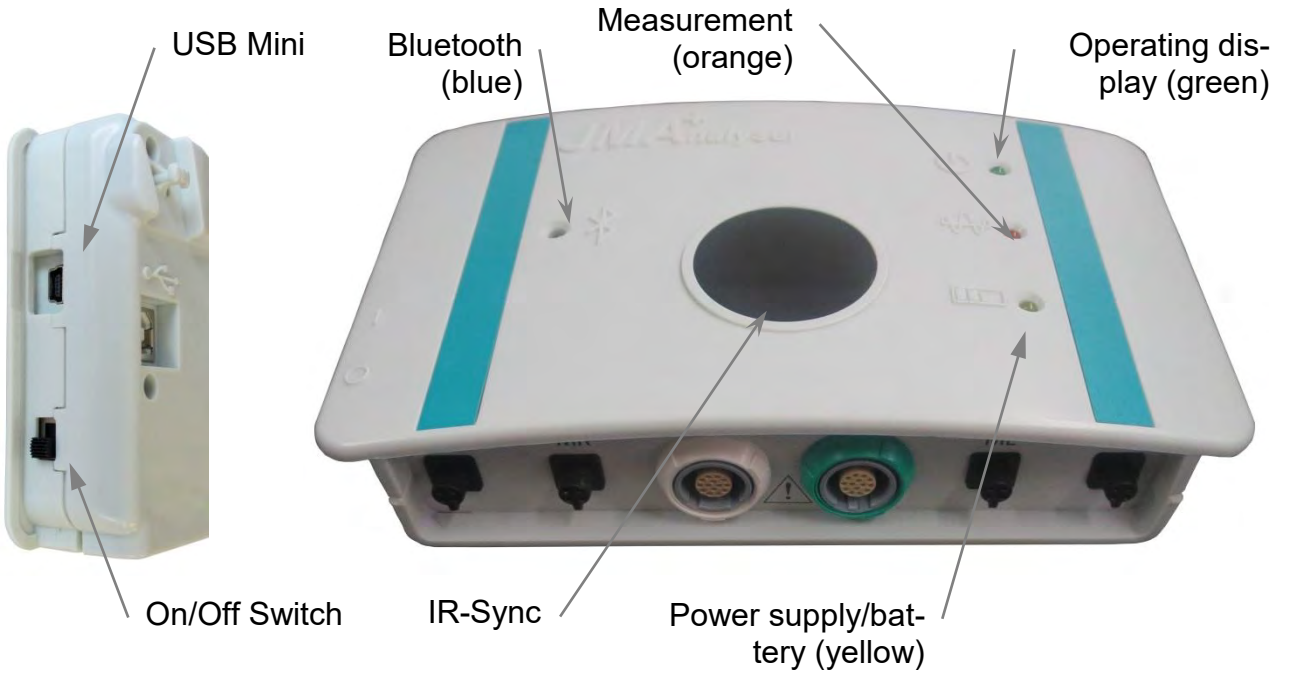

USB Mini

Bluetooth (blue)

Measurement (orange)

Operating display (green)

On/Off Switch

IR-Sync

Power supply/battery (yellow)

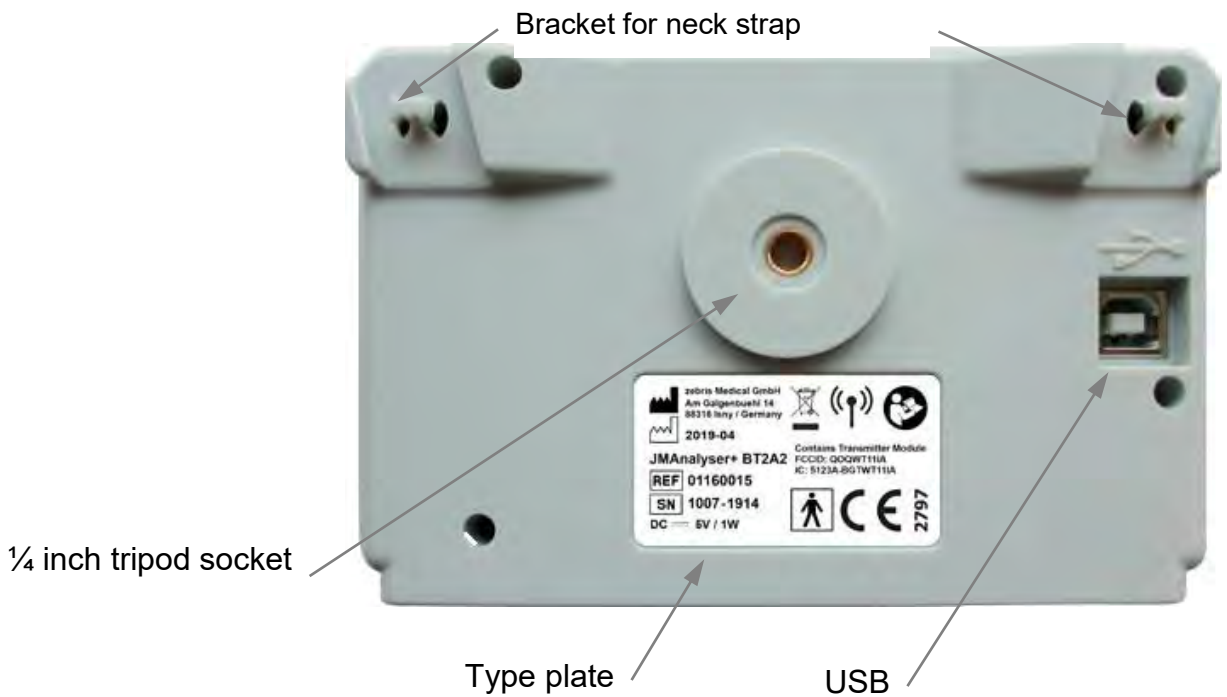

Bracket for neck strap

1/4 inch tripod socket

Type plate

USB

### 3.5 Control elements and Connectors JMT+

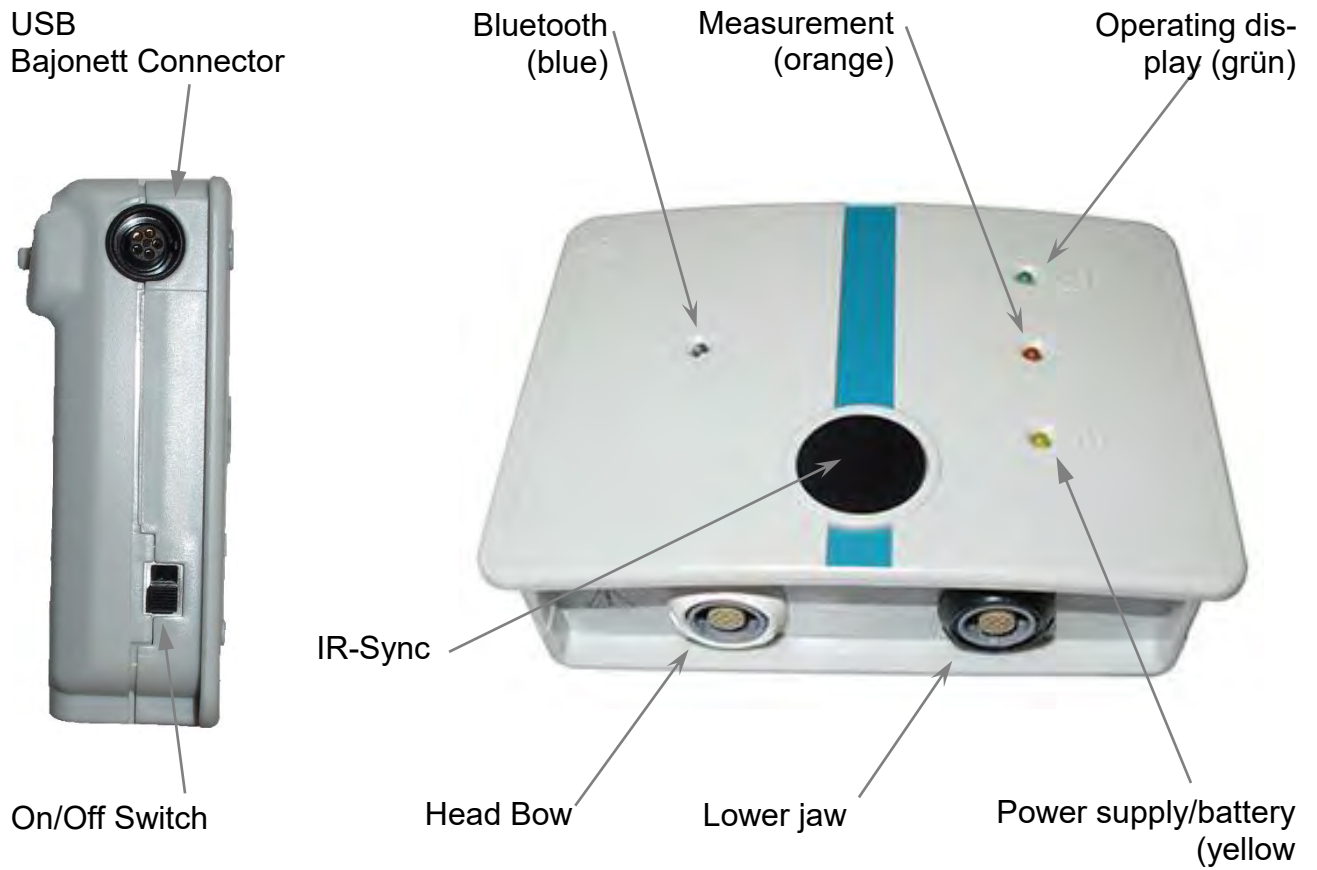

### 3.6 Meaning of the Display lights

LED	ON/OFF Switch	Meaning
<b>Green / operational status indicator</b>		
<b>off</b>	0 (off)	The measurement system is NOT in operation
<b>on</b>	1 (on)	The measurement system is in operation
<b>Orange / measurement</b>		
<b>off</b>	1 (on)	The measurement system is initializing and ready for measurement.
<b>flashes</b>	1 (on)	The measurement system is waiting for initialization, measurement not possible yet.
<b>on</b>	1 (on)	The measurement has started / ultrasonic transmitters are active.
<b>Yellow / battery charging status</b>		
<b>off</b>	1 (on)	USB cable and/or charger connected, reduced charging as soon as charging status > 95%
<b>flashes</b>	0 (off)	USB cable and/or charger connected, battery charging, charging status < 95%
	1 (on)	Battery level critical < 20% Connect the USB cable or charger immediately, as it is possible that data will be lost if the measurement is continued.
<b>on</b>	0 (off)	USB cable and/or charger connected, battery fully charged, charging status 100%
<b>Blue / Bluetooth connection</b>		
<b>off</b>	1 (on)	The measurement system initializes and is ready for measurement.
<b>on</b>	1 (on)	The measurement has started / the measurement system is connected with the PC via Bluetooth



### 3.7 Assignment of the connecting sockets

#### Foot pedal / digital input (black)



Signal	Pin
GND	Pin 1
BSL_START	Pin 2
+3,3 Volt	Pin 3
n.c.	Pin 4
START_in	Pin 5
n.c.	Pin 6
Dig. Input	Pin 7

#### Lower jaw Sensor / digital input (light green)

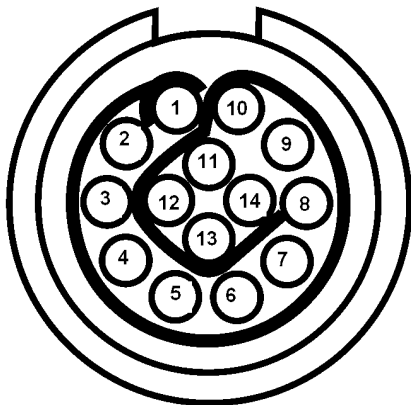

Signal	Pin
Marker 1	Pin 1
Marker 2	Pin 2
Marker 3	Pin 3
Marker 4	Pin 4
SSWBus	Pin 5
n.c.	Pin 6
SDA (I <sup>2</sup> C)	Pin 7
SCL (I <sup>2</sup> C)	Pin 8
+3,3 Volt	Pin 9
DRY_A	Pin 10
DRY_G	Pin 11
Dig. Input	Pin 12
GND	Pin 13
GND	Pin 14

#### Head bow / digital input (white)

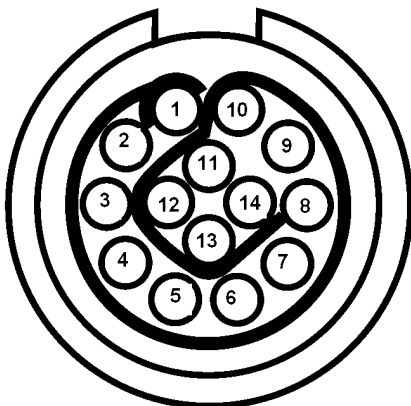

Signal	Pin
Microphone 1	Pin 1
Microphone 2	Pin 2
Microphone 3	Pin 3
Microphone 4	Pin 4
SSWBus	Pin 5
Mik-Select	Pin 6
SDA (I <sup>2</sup> C)	Pin 7
SCL (I <sup>2</sup> C)	Pin 8
+3,6 - 12Volt	Pin 9
DRY_A	Pin 10
DRY_G	Pin 11
Dig. Input	Pin 12
GND	Pin 13
GND	Pin 14

#### analog input (black)

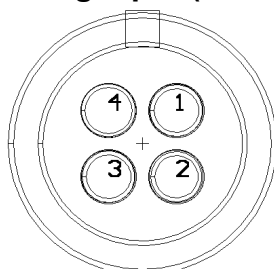

Signal	Pin
Power (+)	Pin 1
Signal	Pin 2
GND	Pin 3
n.c.	Pin 4

### 3.8 Digital Inputs

The measuring system JM product family is equipped in standard specification with an, against reverse polarity protected digital input. It allows digital events such as are transmitted to the application programs from the footswitch.

To activate the inputs they are connected to the ground provided on each terminal.

Input resistance	10 K $\Omega$ (pull-up)
V <sub>IH</sub> (High-Level Input Voltage)	> 2,0V
V <sub>IL</sub> (Low-Level Input Voltage)	< 0,8V
Min. signal duration in order to cause a triggering	1mS

The digital input is set to +5V („1“) with an internal pull-up resistor. By pulling this input up to 0V („0“) through a switch, relay contact or similar, the input is triggered.

### 3.9 EMG for the determination of the muscle tone of the jaw muscles

As an optional extension of the device, for the synchronous recording of the EMG data, zebris offers EMG differential electrodes amplifier cables as an accessory that are optimally adjusted to the JMAlyser+ BT system:

REF: 0124.0031 / EMG-DENTAL N amplifier

REF: 0124.0041 / EMG-DENTAL amplifier

The EMG differential electrodes amplifier cables are directly connected to the JMAlyser+ system and thanks to their particularly small electrode contacts are particularly suitable for the use in dental medicine. The EMG data is evaluated as a transient Signal. Please find further notes on the application of the EMG module in the zebris WINJAW+ software manual.



Connections for analogue amplifier cable

#### Technical specifications analogue inputs Main Unit

DC Input resistance	16 K $\Omega$
Supply- voltage	$\pm$ 5V DC
Input voltage Range	power supply $\pm$ 2V
Sample Rate	1000Hz max.



WARNING

The EMG double electrodes (REF 810.0026) are not reusable and intended for single use only.

If other EMG electrodes are used than those recommended by zebris, the user shall bear sole responsibility for their biological compatibility.

### 3.10 Active differential electrode cable

#### Technical data

Supply voltage	$\pm 5V$ to $\pm 15V$ green LED indicates ready state
Input impedance	$10E + 12 \Omega$
CMRR	110 dB
Noise referred to input	0.28 $\mu V$ pp
Band width	7 Hz to 500 Hz
Output voltage	Supply voltage -1 V
Dimensions	30 x 23 x 9 mm (L x B x H)
Cable length	1.45 m

#### Versions

---

Type	<b>EMG-Dental N</b> with neutral electrode
Item No.	1240041
Gain	1000
Connectors	miniature crocodile clamp

special, miniature electrode connectors  
for use in dental applications



---

Type	<b>EMG-Dental</b> without neutral electrode
Item No.	1240031
Gain	1000
Connectors	miniature crocodile clamp

special, miniature electrode connectors  
for use in dental applications

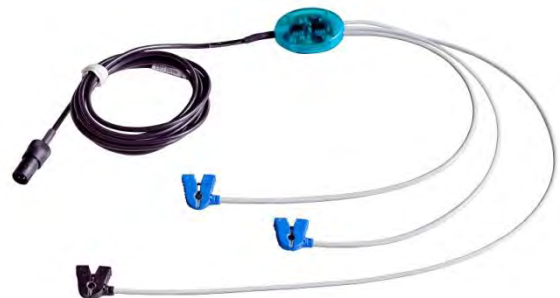







### 3.11 Accessories and spare parts











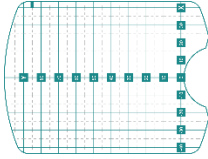





**WARNING**













Multiple use of the disposable accessories leads to an increased risk of infection for the patient and possibly to falsification of the measurement and analysis results due to changes in the shape of the products with multiple use of the sterilization process.

REF-No.	Description	Illustrations
01260010	<b>Head bow type 14R</b> for measurement systems JMAlyser+, JMAlyser+ BT and JMT+  With all application parts	
01260011	<b>Head bow type 34R</b> for measurement systems JMAlyser+, JMAlyser+ BT and JMT+ with illumination of the condylar area  With all application parts	
01260015	<b>Head bow type 43R</b> for measurement systems JMAlyser+, JMAlyser+ BT and JMT+  With all application parts	
01460010	<b>Lower Jaw Sensor Typ 14T</b> for measurement systems JMAlyser+, JMAlyser+ BT and JMT+	
01460015	<b>Lower Jaw Sensor Typ 64T</b> for measurement systems JMAlyser+, JMAlyser+ BT and JMT+	
01860416	<b>USB adapter for JMT+</b>  For connection to the PC	







01860420	<b>USB adapter for JMAlyser+</b> For connection to the PC	
01240031	<b>EMG-DENTAL N amplifier</b> With N electrode, amplification 1000, particularly small electrode contacts, especially suitable for the use in dental medicine.	
01240041	<b>EMG-DENTAL amplifier</b> Without N electrode, amplification 1000, particularly small electrode contacts, especially suitable for the use in dental medicine.	
08100026	<b>EMG double electrodes</b> 1 pack à 25x8 pieces Note: For single use only, not designed for reuse.	
01860020	<b>IR Footswitch</b> for measurement systems JMAlyser+, JMAlyser+ BT and JMT+	
01860010	<b>IR- remote control</b> for measurement systems JMAlyser+, JMAlyser+ BT and JMT+	
01540191	<b>SYNCCam Dental C930</b> Camera with USB-cable, synchronization cable, includes software driver	
33101120	<b>USB power supply unit with country adapter</b> For charging of JMAlyser+ BT and JMT+	
33101121 + Country Code	<b>Country adapter for USB power supply</b> Available types: EC, UK, US, AUS, IEC/World	

01960500	<p><b>Modell positioner</b></p> <p>Positioning table for mounting on the AR-TEX AR Articulator for digital model transmission.</p>	
01960501	<p><b>Positioning screws set</b></p> <p>Set consisting of 3 positioning screws each, in lengths of 30mm, 45mm and 60mm. To set the coupling tray height for the digital model transfer</p>	
01960510	<p><b>Positioning Films Set</b></p> <p>Positioning film for mounting on the model positioner to position transmission for digital model transmission.</p> <p>1 pack of 5 pieces</p>	
01960130	<p><b>Nasion support</b></p> <p>fitting for all zebris head bows</p>	
01960140	<p><b>Bearing seat</b></p> <p>fitting for all zebris head bows</p>	
01960120	<p><b>porion coupling</b></p> <p>for fixation of the face bow at patients auditory canals</p>	
01910025	<p><b>pointer 80</b></p> <p>medical steel, sterilize able length 80mm, ball aperture 1,5 mm</p>	
11502501	<p><b>Bearing cushion green</b></p> <p>for bearing seat 196.0140 packaging unit 5 pieces</p>	
11502503	<p><b>Nose cushion green</b></p> <p>packaging unit 5 pieces</p>	

90061012	<b>Elastic neckband</b> packaging unit 5 pieces	
11502508	<b>Headband black, green</b>	
01960007	<b>Lanyard black, green</b>	
01960121	<b>Ear hygiene cap</b> To use in combination with porion coupling 01960120. Packing unit 10 pieces	
01960260	<b>Para-occlusal attachment 90</b>  for the fixation on the front teeth. Suitable for gas- and steam sterilization. NOTE: Single use item, not intended for multiple use.	
01960271	<b>occlusal adapter</b> for the fixation of the lower jaw sensor at the occlusal attachment. Suitable for gas and steam sterilization.	
01960270	<b>occlusal attachment</b>  made from LEXAN, suitable for gas and steam sterilization. NOTE: Single use item, not intended for multiple use.	
01960310	<b>bite fork type ZE</b>  made from LEXAN, suitable for gas and steam sterilization. NOTE: Single use item, not intended for multiple use.	

01960320	<b>bite fork type SD</b> made from LEXAN, suitable for gas and steam sterilization NOTE: Single use item, not intended for multiple use.		
01960340	<b>bite fork type PS-1</b> made from LEXAN, suitable for gas and steam sterilization NOTE: Single use item, not intended for multiple use.		
01960400	<b>Bite fork adapter</b> for attachment of the UK-sensor to the bite fork NOTE: Single use item, not intended for multiple use.		
21030152	<b>Bluetooth USB-Stick</b> with Plug and Play function		
07210000	<b>WINJAW+ License Enhancement</b> Extension for installation on an additional computer		
07210010	<b>WINJAW+ Basic application</b> for operating system Windows 7 and Windows 10 32/64 Bit		
07210102	<b>WINJAW+ Software-Update</b> for operating system Windows 7 and Windows 10 32/64 Bit		
07210200	<b>WINJAW+ application Function</b> for 3D and function analysis		
07210211	<b>WINJAW+ application EMG Relax &amp; Bite</b> for electromyographically determination of muscular activation potentials. Please beware that for usage the following Hardware 01160015 / 01160015 and 01240031, 01240041 und 08100026 is necessary.		



07210220	<b>WINJAW+ application Jaw Relation</b> for designation of neuro muscular jaw relation.	
07210230	<b>WINJAW+ application Plane Finder</b> for designation of adjustment parameters for articulator Zirkozahn PS1-3D	
07210240	<b>WINJAW+ application Face-Imager</b> Software module for display of camera and video data. Please beware of that for usage of this software module the hardware 01540191 is necessary	
07210250	<b>WINJAW+ option CSV-Export</b> Enables the export of the report parameters as well as the movement data into export files to be opened with MS Excel.	
07210260	<b>WINJAW+ Module Digital model trans- mission</b> For the operating systems Windows 7 and Windows 10 32/64 bit	
79010231	<b>Hardware User Manual</b> The print edition is subject to a charge. Availability from 5 working days after re- ceipt of order.	
79010245	<b>Software User Manual</b> The print edition is subject to a charge. Availability from 5 working days after re- ceipt of order.	

## 4 Putting the measurement system into operation

For the commissioning of the jaw motion analysis system, a zebris USB-cable adapter, as well as the installation CD is required with the WINJAW+ application software. All components are included in the scope of delivery for the JM-measuring system.

### 4.1 Power supply & charging the battery (JMAlyser+ BT and JMT+)

To charge the batteries of the measuring systems JMAlyser + BT and JMT+ please switched in off state, connect the charging power pack into an AC outlet. Please connect the measuring system via the included USB adapter with the charging power pack. Alternatively, the measuring system can be charged or operated directly on the USB port of a PC. Connect to the measuring system directly to the PC, by using the supplied USB adapter.

The batteries are fully charged after approximately 5 hours to charge.

A full battery charge is sufficient for a measurement time of 3.3 hours in continuous operation. That means a permanent connection of the measuring system via Bluetooth and a through-going data transmission of moving data transmitted to the software, saying it will continuously send and receive ultrasound.



WARNING

Only connect the USB charger that is approved and supplied by zebris, and arrange the measurement system such that the plug for the power socket is easily accessible at all times and the device can be easily disconnected from the mains.



USB charging power supply / REF 33101120



NOTE

Before connecting the charger to the mains, consult the name plate information on the power supply unit, checking that the voltage and frequency is consistent with the local data. Only connect if such consistency is given.



WARNING

Carry out a full visual inspection to the power supply unit, power cable and plug, as well as the protective contacts before the connection and/or operation of the measurement system. Damaged power supply units, cables or plug connectors must be replaced immediately by an authorized person.

## 4.2 IT security and software installation

If the system is not shipped with a computer and properly installed WinJaw + software, the operator is responsible to ensure that the safety of patients, operators and environment is not compromised by the computer. If in question please contact a dealer authorized by the manufacturer.

For the requirements of the WinJaw + Software with concern to a PC/laptop, please refer to the instructions for use of the WinJaw + Software.

In order to provide easy integration into an existing system for data backup and to store personal data separately from the PC the data base of the application software can be installed on a network server.

If the database of the WinJaw+ software is stored on a storage medium connected via an IT network, the following requirements have to be met:

- the data connection must be secured against interference by third parties,
- the data connection must be secured against disconnections,
- applicable data protection regulations must be adhered to for the data connection in the IT network as well as for the location in the IT network,
- access to the location in the IT network must be restricted to the authorized group of persons,
- the exchange of data between the WinJaw + database and the IT system is realized via the SMB protocol,
- the exchange of data with third party devices in the IT network is not provided.



If the requirements listed above are not met, the following hazardous situations may arise:

- Data loss due to disconnection during data transfer between WinJaw + software and IT network,
- Unauthorized access to personal data by third parties,
- Complete data loss due to missing data backup in the event of disruptions and / or damage to the IT network.



The manufacturer is unable to accept any liability for damage or functional errors that are caused by faulty software installation or unsuitable computer hardware. If the operator installs additional hardware or third party software, this occurs based on the sole responsibility of the operator and is not covered by the manufacturer's liability.

The computer needs to be CE-marked and needs to satisfy the requirements of DIN EN 60950 and/or DIN EN 60601-1.



Connecting the system to a network/data pool can cause unforeseen risks to the patient and third parties. The WinJaw+ database is not intended for simultaneous use by multiple users.

If the database of the WinJaw+ software is installed in a network/data pool, the operator is obliged to ascertain, analyze, evaluate and manage all of the associated risks. In this context, the aspects of data protection, virus safety, updates to the operating system and regular backups are of particular importance. The risk assessments also have to include the subsequent changes to the network/data pool, such as updates/upgrades to devices and components that are connected with the network.

The connection of the PC system to the Internet must take place via a professionally maintained IT network in conjunction with a hardware firewall in order to minimize risks due to the Internet connection. Never use the local computer with Internet access with administrator rights.



For the safe operation of the measuring system are the aspects of data protection, virus security, updates of the operating system and regular backups of the WinJaw+ database on external data carriers of essential importance and to be implemented by the user as measures of IT security.

If the system is delivered without PC/laptop, please install the application software before connecting the JM-system to the computer. Please find information on the installation in the user manual of the WinJaw+ software.



If you encounter problems with the hardware driver of the JM-system, please disconnect the USB cable from the PC and restart it.



Installing a virus scanner on the PC can interfere with the proper functioning of the application software. The manufacturer is not liable for damages caused by such programs.

### 4.3 Connecting the accessory Parts

Connect the head bow, lower jaw sensor and possible foot switch with the corresponding colored socket on the measurement system.



NOTE

Please note when connecting the head bow, lower jaw sensor and foot switch to the measuring system that the plugs are protected by a coded plug system against reverse polarity or plugging in the wrong book-se. All plugs should always glide smoothly and without major force in the bushes.

Next, connect the measurement system and a USB interface on your computer with the USB cable provided, or set up the Bluetooth connection. In this context, it is necessary to ensure that the measurement system is switched on. Your measurement system is now ready to use. Detailed instructions on the operation of the JM-measuring systems are provided in the operating instructions for the zebris WINJAW+ software.

## 4.4 Connection of the basic unit via USB Interface

If the measuring system is operated via USB interface, the device is automatically recognized by the zebris WINJAW+ software. Wait until the hardware installation process has finished and the following message appears.

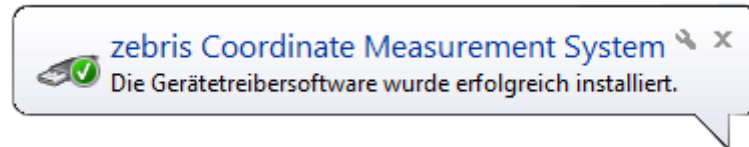

Now the measuring system is ready for use and can be found in the software under device settings.

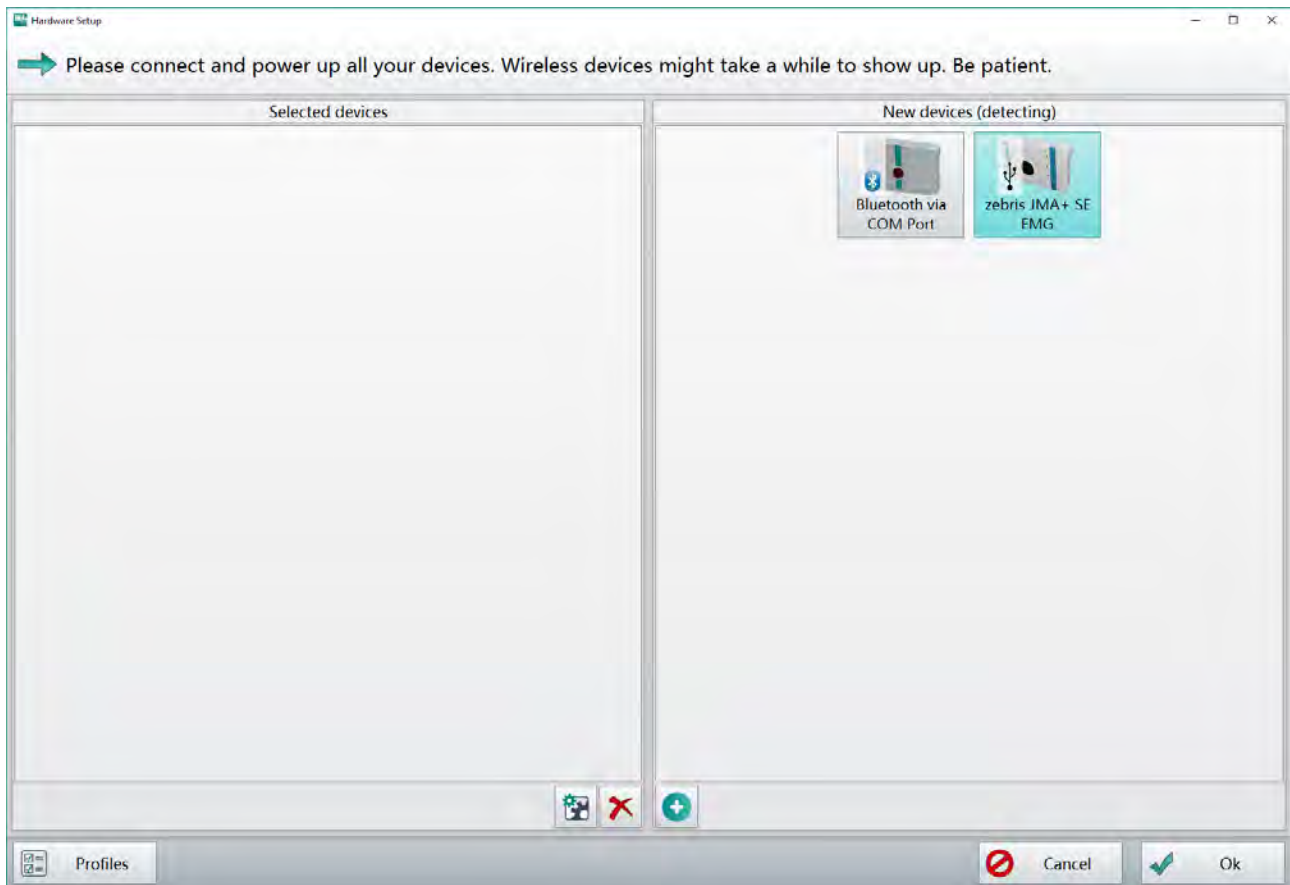

For more information on installation please refer to the operating instructions for zebris WINJAW+ Software.

## 4.5 Connection of the basic unit via Bluetooth interface

### 4.5.1 Bluetooth connection via automatic Bluetooth device detection

If your PC has an integrated Bluetooth interface or you have received the zebris Bluetooth USB dongle with your system, it is possible to connect the JM- measuring system directly from the WINJAW + user software via Bluetooth.

For this purpose please open the device settings and switch on your JM-measurement system.

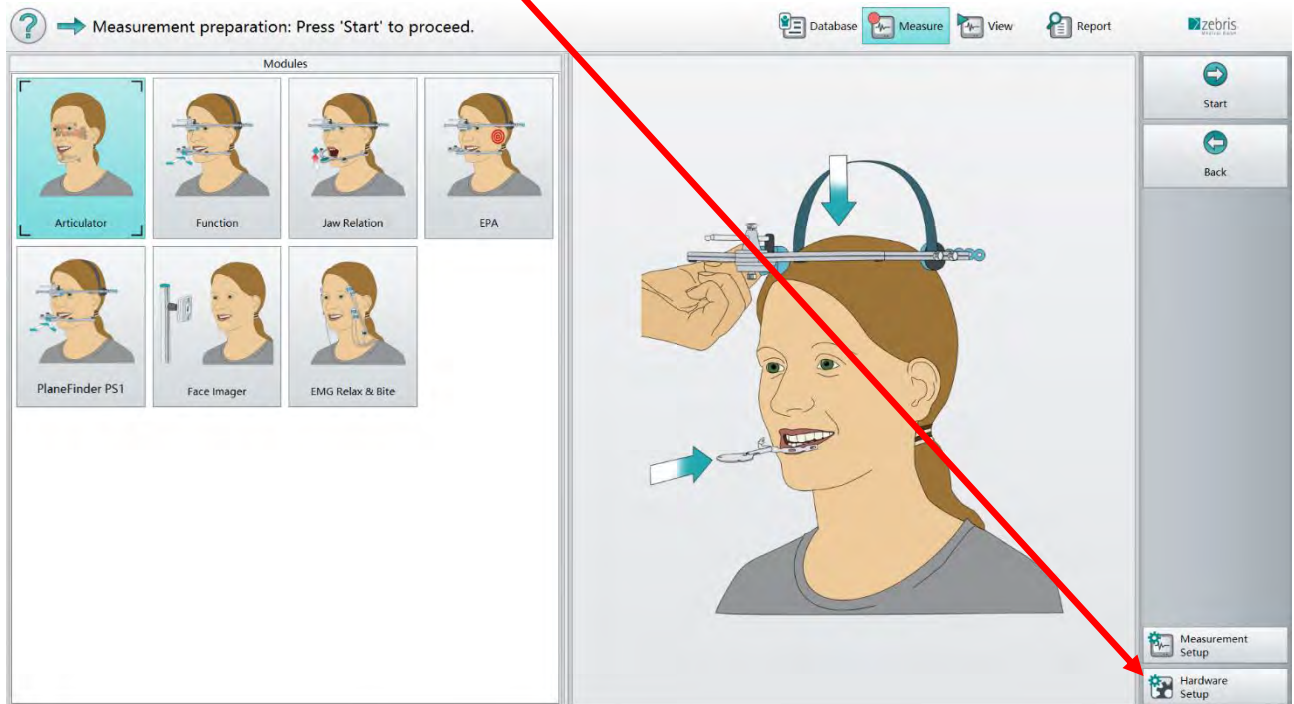

The device manager in the device settings now automatically searches for an existing Bluetooth device to connect it to the PC and the WINJAW + software. This process may take several minutes.

Once your device is found, it is displayed on the left side of the device manager. Please select the device by double clicking the icon of the device.

Additionally, you can simply select the device with a simple click, so that it is highlighted in green and then click the "Add" icon.

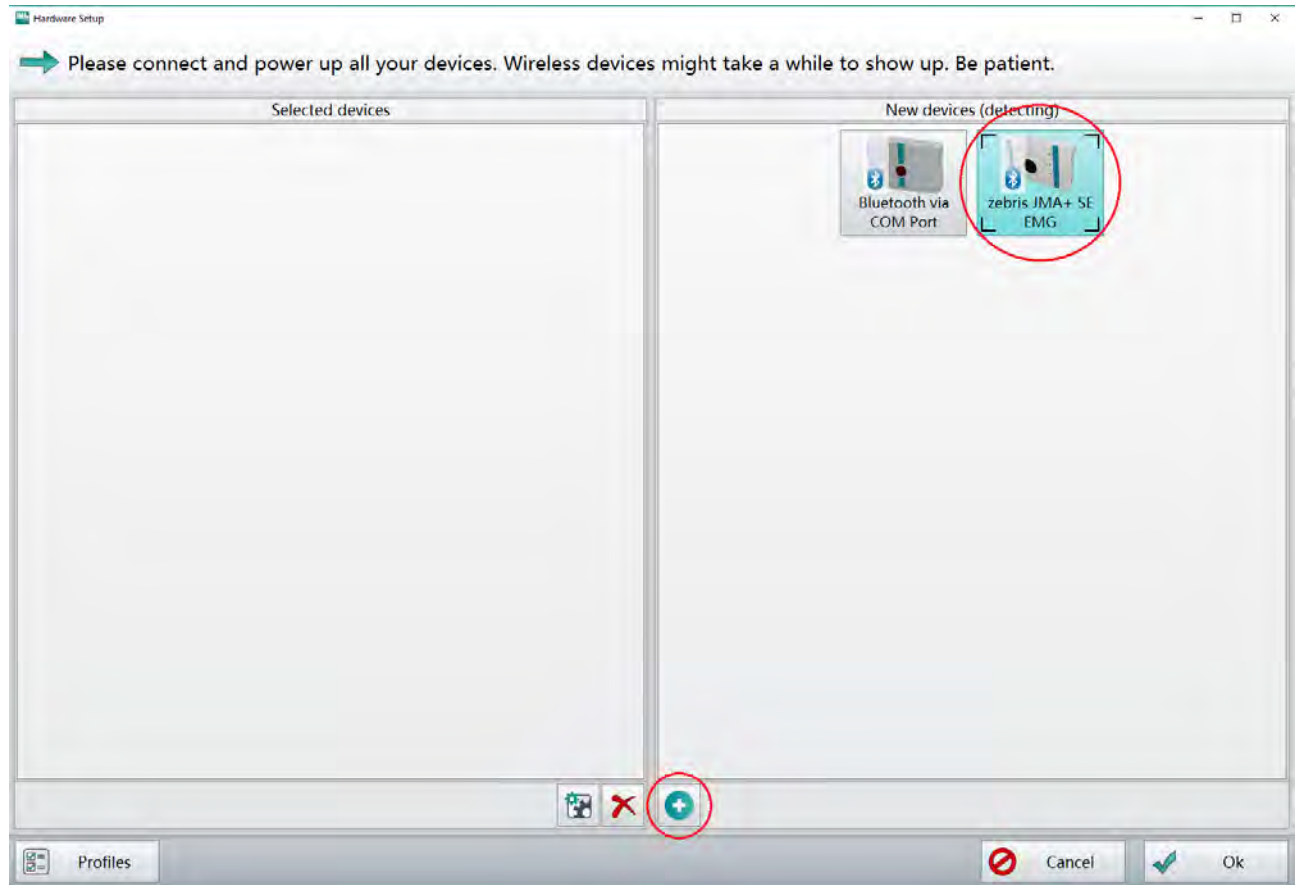

A Windows task is now displayed in the lower right-hand side of the screen, which can be used to establish a connection via Bluetooth.

Please click on this task to perform the automatic pairing.

## 4.6 Taking the measurement system out of operation

To take the measurement system out of operation, please start by closing the WINJAW+ software, shutting the PC down, and switching it off. Next, switch the JM-measuring system off and decouple the USB connection from the PC or charger. Next, unplug the charger from the socket.



## 5 Control measures, Preparation, Disposal

- Scheduled maintenance of the system is essential in order to prevent damage and guarantees the safety of the device. All methods concerning the system's maintenance and disinfection mentioned in this user manual should be carried out on a regular basis.
- Should any malfunctions and/or defects be determined or suspected, the device must be put out of operation immediately, marked as "Out Of Service" and prevented from being used by removing the mains cable. In such case be sure to contact the manufacturer or an authorized sales partner.
- The maintenance of the device or its accessories, going beyond the procedures described in this user manual, must exclusively be carried out by zebris Medical GmbH or a person who has been explicitly authorized by zebris to do this.
- Be sure to switch off the measuring system and disconnect it from mains supply before starting any maintenance work.

### 5.1 Mandatory periodic inspections and STK

- The zebris Medical GmbH does not stipulate any safety-related control for the JM-measuring systems.
- For maintaining the correct state of the electrical equipment, checks and technical safety inspections have to be carried out repeatedly (e.g. within Germany, acc. to BGV A3, and accident prevention regulations and technical safety tests according to the Medical Device Operating Regulations). Here it should be noted that standard regulations for electrical devices are concerned here and not measures that are specific to zebris.
- For safety reasons it is recommended before each use of the measuring system, to check the correct state of all the connection leads, as well as the mains cable, mains plug and mains socket. Should certain parts be damaged, these must be replaced before continuing to use the measuring system.
- Immediate maintenance measures are to be carried out if:
  - a) Fluid enters the device
  - b) Cable or cable connections have been damaged
  - c) Parts of the sensors were damaged
  - d) Covers have been damaged
  - e) A malfunction or a fault is suspected or has been detected
- If the type plate or other important labels (warning notices) are damaged or obliterated they have to be replaced by the manufacturer for safety reasons.



**WARNING**

For service work, please always send all system components together in the original case to your dealer or the manufacturer.

## 5.2 Checking the measurement function



The JM system must be inspected at regular intervals to ensure that it is functioning properly and that patient safety is permanently guaranteed.

After hard blows, or if the head bow or UK sensor has fallen to the ground, the measuring function must be checked immediately.

No further measurements may be carried out in the event of visible damage to system components (deformation, dents, cracks).

- The ultrasonic transmitters of the lower jaw sensor can be inspected for this function during a measurement by listening to see whether a regular cracking is emitted from each of the transmitters.
- To inspect the system, for known jaw function measurements (e.g. known maximum opening width, known condylar range of motion with protrusion, known horizontal condylar guidance inclination), the user can measure himself with the measurement system. These measurement results should correspond with the known values.
- When the sensors do not move, the zebris WINJAW+ software should show an un-moving image of the lower jaw. Possible deviations (spikes or jumps in the measurement curve in spite of unmoved markers, incorrect presentation of the lower jaw, etc.) indicate a faulty measurement and impair the evaluation
- Should there be any doubts surround the measurement accuracy, please send the device to inspection at zebris in order to ensure the stated measurement accuracy.

## 5.3 Troubleshooting

Please check the following points if technical malfunctions should occur:

- ✓ Is the device switched on and being supplied with electricity? (green operating display LED is lit on the measurement system, batteries are charged or charger and/or USB cable is connected)
- ✓ Has the USB connection and/or Bluetooth connection between the measurement system and measuring PC been made correctly?
- ✓ Are all the other components in the measurements system (head bow, lower jaw sensor, foot pedal) connected correctly?



NOTE

Please find further information on error messages and troubleshooting in the user manual of the zebris WINJAW+ software.

### Checklist for the reception of error messages



NOTE

In order to support you the best way possible in case of malfunction of your JM-measuring system, our service employees need the following information:

- ✓ Serial number of the JM-measuring system and the lower jaw sensor/head bow  
The serial numbers are on the name plates on the rear of the measurement system and/or on the cables for the head bow and lower jaw sensor
- ✓ zebris WINJAW+ software version
- ✓ Operating system version of your measurement PC  
e.g. Windows 7 Professional Service pack 1  
(to find under Windows 7: Windows Start button → Control Panel → System)
- ✓ Further components connected to the measurement system  
zebris DAB-Bluetooth, Video-Kamera
- ✓ List of all USB/Bluetooth devices connected to the measurement system  
e.g. mouse, printer, other measuring systems, etc.
- ✓ Screen shot of the error message, or exact wording  
e.g. „Timeout reading from USB“
- ✓ Precise and detailed description of the procedure that has led to the error message.  
e.g. Measurement “Type A” started, then clicked on button “B”, afterwards carried out movement “C”, switched to function “D”, when switching back, the error message xyz occurred etc.

## 5.4 Preparation Methods



NOTE

After every case of use of the JM-measuring system, a re-preparation is required according to DIN EN ISO 17664. All accessory parts that come into contact with the patient's mucosa have to be sterilized before use.



WARNING

Before starting cleaning work or disinfection, switch the measurement system off under all circumstances and disconnect it completely from the power supply network.

The following accessory parts are only intended for one-off use on a patient, and should not be prepared again after use.

- Para-occlusal attachment
- Occlusal attachment
- Biteforks of all types
- EMG double electrodes



The accessories listed above must be sterilized before use on the patient. (please refer to chapter sterilization)

### 5.4.1 Manual disinfection

The electrical components of the measurement system can be wipe-disinfected with suitable solutions. Disinfect all electrical components (head bow, lower jaw sensor, foot pedal, IR remote control, IR-Footswitch) with a cloth that has been dampened with a disinfection solution.



WARNING

#### No spray disinfection!

Spray disinfection can destroy the highly precise measurement sensors of the platform.



### Recommended disinfection agent

Composition approx. 25% ethanol, 35% Propanol

E.g. Mikrozid Liquid / Schülke & Mayr; Original CaviCide / Kerr Corporation or similar agents



NOTE

If you apply disinfection agent be sure to follow the recommendations given by the manufacturer of the disinfection agent strictly. Especially consider the rules concerning the commended application time of the agent.



WARNING

Due to danger of confusion, chemicals that are necessary for the disinfection or cleansing exclusively must be stored, prepared and provided in containers that are appropriate for this purpose.

## 5.4.2 Manual cleaning

### Electrical components:

The cleaning of electrical components (face bow, lower jaw sensor, IR remote control, IR-foot switch) should only be carried out when the system is switched off and the USB power supply and/or USB cable are unplugged, and using a damp cloth.

### Cleaning prior to sterilization:

- Prior to sterilization, clean the accessory parts by hand under running water (drinking water quality,  $30\text{ °C} \pm 5\text{ °C}$ , flow rate 2 liters/min.) with a medium strength toothbrush for 30 seconds.
- Complete the sterilization immediately subsequent to the cleaning.

## 5.4.3 Sterilization

All accessory parts that come into contact with the patient's mucosa have to be sterilized before use.



NOTE

The sterilization has to be completed immediately subsequent to the cleaning.

Sterilize the bite-forks, bite fork adapters and lower jaw attachments with a fractionated pre-vacuum for four minutes at  $134\text{ °C} \pm 1\text{ °C}$  and 2 bar (can be sterilized up to a max. of  $138\text{ °C}$ ).

## 5.5 Disposal

### 5.5.1 Packaging

All transport packaging's delivered by zebris can be recycled within Germany via the local recycling depots. In order to provide the reuse of the recyclable material contained in the packaging, the zebris Medical GmbH takes part in the dual ZENTEK system that takes over the proper disposal of packaging.



### 5.5.2 Disposal of electronics

This symbol states that according to the directive on waste electrical and electronic equipment (2012/19/EEC) the product must not be disposed by means of the domestic waste system. Within Europe this device must be forwarded to a specific waste disposal system.

Therefore regular disposal is carried out by the manufacturer. For this purpose the system should be shipped to the manufacturer and will be forwarded to regular disposal by zebris.

The improper interaction with electronic waste could lead to negative effects for the environment and the public health because of potential hazardous materials which are frequently contained within electric and electronic devices. Additionally with the proper disposal of this product you will contribute to the effective use of natural resources.

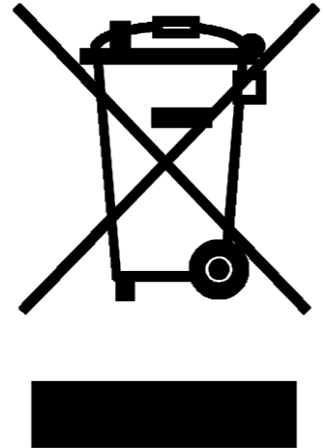

### 5.5.3 Accumulators and batteries

Accumulators and batteries must not be disposed of with domestic waste! In the interest of environmental protection, the consumer is legally obliged (battery regulation) to return old and used batteries. Used accumulators and batteries can be disposed of at the collecting points of the community or where batteries of the relevant kind are sold. For consumers, the batteries are taken back free of charge.

## 6 Safety standards and system classification

### 6.1 Classification acc. to Annex IX of Directive 93/42/EEC

The system is then classified as medical product **Class I with measuring function**.

### 6.2 Safety of medical electrical devices

The device fulfils the requirements of the standard DIN EN 60601-1:2013.

Classification according to DIN EN 60601-1

Type BF

Safety class II

Steady state conditions

Unsuitable for use in an oxygen-enriched atmosphere

#### 6.2.1 Connecting the JM measurement - system to other electrical devices

(Quod vide DIN EN 60601-1:2013 section 16 medical electrical systems)



WARNING

The JM-measuring system may only be coupled with other electrical devices if these conform to the provisions of DIN EN 60950 or DIN EN 60601-1 or zebris Medical GmbH has confirmed their compatibility.



WARNING

When coupling several devices to one measuring station, please note that no danger through summation of leakage currents can occur.

Devices that are in direct contact with the patient and that are commonly used in a medical electrical system, as a whole have to fulfil all requirements of DIN EN 60601-1:2013 section 16.

There is a danger of electric shock when touching devices that are not grounded separately.

## 6.2.2 Vicinity of the patient / test person

For the definition of the patient's surroundings, experience shows that a value of 1,5 m distance to the patient is optimal.

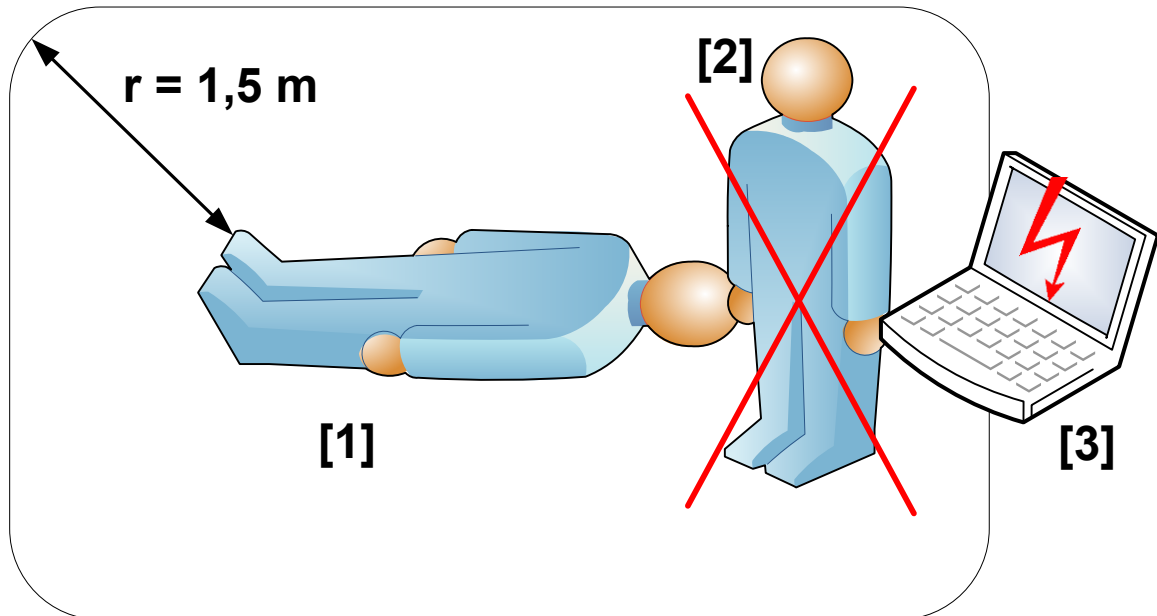

When operating the system, the user [2] must ensure that he does not touch the PC [3] and the patient [1] at the same time. The same applies for all other non-medical, electrical components; they may only be used outside the patient's vicinity.

Furthermore, the user must ensure, never to touch the contacts of the connectors of the interface box and the patient at the same time.

In case of non-observance, dangerous leakage currents can occur.

The following components of the JM-measuring system may be used in the vicinity of the patient:

- JMANalyser+ or. JMT+ including face bow and UK-sensor
- zebris Measuring Systems for medical purposes (e.g. FDM-Plattform, EMG)



The computer and other non-medical electrical equipment (e.g. camera equipment, lights) have to be located beyond the reach of the patients (1.5m).



### 6.2.3 Multiple Sockets



If multiple sockets are used for connecting the JMA Optic system or its components (especially PC and inductive charger), the following safety regulations are to be observed:

It is extremely dangerous to use multiple sockets for combining the mains connection of components of Medical Electrical Equipment Systems with non medical components that. It is possible for excessive touch currents to occur if mains are connected without the user having any respective expert knowledge. In the worst case, the impedance of the protective conductor system limits the short-circuit current in such a way that the fuse does not trip.

The manufacturer advises to connect the power supply of the face bow always directly to a wall socket with a tested protective earth and separate fuse.

- If multiple sockets are used jointly for face bow and PC / inductive charger the multiple socket and complete interconnection of the system must adhere to all the requirements of DIN EN 60601-1:2013 Section 16. If necessary, an isolating transformer is to be used for an arrangement of this kind, and the ground leakage current in the protective earth conductor of the multiple sockets must not exceed 5 mA. The adherence to the maximum permissible patient leakage currents is to be verified by measuring. If a multiple socket was integrated after setting the system into operation for the first time, no additional device may be connected to it (use multiple sockets with locking covers for this purpose)
- Multiple sockets must not be placed on the floor to avoid accidentally penetration of liquids or mechanical damages.
- It is forbidden to use several multiple sockets connected in series.
- Multiple sockets can be used without causing any danger for connecting the PC and inductive charger outside the patients' vicinity.

## 6.3 Electromagnetic compatibility Guideline & Manufacturer Declaration

The JM-measuring system satisfies the requirements of the EN 60601-1-2 standard.

Detailed information on EMC values and information supplied by the manufacturer can be found in the tables in this Section of the User Manual.

Electrical equipment in the medical field is subject to particular precautionary measures as regards the EMC (Electromagnetic Compatibility) and must be installed and put into operation in accordance with the instructions given below.



WARNING

Even though the motion analysis systems JMAlyser+ and JMT+ fully complies with the requirements of the standard EN 60601-1 it cannot be totally excepted that portable and mobile RF communications equipment can affect the system. If ever possible such devices should not be operated within the system environment during measurements



WARNING

The use of accessories, particularly cables for connecting to the PC, that are not supplied by zebris for use with the JM-measuring systems, or explicitly recommended for use with the device, can lead to a reduced resistance to EMC interference of the JM-measuring system.



WARNING

The JM-measuring system should not be operated in the vicinity of e.g. X-ray equipment, motors or transformers with a high connected load, as electrical or magnetic interference fields can influence the measurements. The same is applicable for neighboring power lines and equipment without a CE mark. Should operation next to possible sources of interferences be necessary it is mandatory to check and verify the correct function of the system.

## Guidelines and Manufacturer's Statement - Electromagnetic Emission

The jaw motion measuring systems are intended for use in the electromagnetic environment described below. The customer or user of the jaw motion measuring system should ensure that it is operated in such an environment.

Emitted interference measurements	Compliance	Electromagnetic environment guidelines
RF emissions acc. to CISPR 11	Group 1	The jaw motion measuring system product family uses RF energy exclusively for its internal functions. Therefore its RF emission is very low and it is unlikely that electronic equipment in close proximity will experience interference.
RF emissions acc. to CISPR 11	class B	The jaw motion measuring system product family is intended for use in all facilities including those in residential areas and those directly connected to a public utility network also supplying buildings used for residential purposes.
Emission of harmonic oscillations acc. to IEC 61000-3-2	class B	
Emission of voltage fluctuations / flickers acc. to IEC61000-3-3	in compliance	

## Guidelines and Manufacturer's Statement - Electromagnetic Interference Immunity

The jaw motion measuring system product family is intended for use in the electromagnetic environment described below. The customer or user of the jaw motion measuring system should ensure that it is operated in such an environment.

Interference immunity tests	IEC 60601 test levels	Compliance level	Electromagnetic environment guidelines
Electrostatic discharge (ESD) acc. to IEC 61000-4-2	± 6 kV contact discharge ± 8 kV atmospheric discharge	± 6 kV contact discharge ± 8 kV atmospheric discharge	Flooring should be of wood or concrete or laid with ceramic tiles. If the flooring is made of synthetic material, the relative humidity must be at least 30%.
Fast transient electrical interferences/bursts acc. to IEC 61000-4-4	± 2 kV for power lines ± 1 kV for input and output lines	± 2 kV for power lines ± 1 kV for input and output lines	The quality of the supply voltage should be the same as the voltage of a typical business or hospital environment.
Surges acc. to IEC 61000-4-5	± 1 kV differential mode voltage ± 2 kV common mode voltage	± 1 kV differential mode voltage ± 2 kV common mode voltage	The quality of the supply voltage should be the same as the voltage of a typical business or hospital environment.
Blackouts, brownouts and fluctuations of the power supply acc. to IEC 61000-4-11	< 5% $U_T$ (> 95% crash of the $U_T$ ) for ½ period 40% $U_T$ (60% crash of the $U_T$ ) for 5 periods 70% $U_T$ (30% crash of the $U_T$ ) for 25 periods < 5% $U_T$ (> 95% crash of the $U_T$ ) for 5 s	< 5% $U_T$ (> 95% crash of the $U_T$ ) for ½ period 40% $U_T$ (60% crash of the $U_T$ ) for 5 periods 70% $U_T$ (30% crash of the $U_T$ ) for 25 periods < 5% $U_T$ (> 95% crash of the $U_T$ ) for 5 s	The quality of the supply voltage should be the same as the voltage of a typical business or hospital environment. If the user of the jaw motion measuring system requires the continuation of functionality also after power interruptions/disruptions, it is recommended to provide the jaw motion measuring system with power from an uninterruptible power supply.
Magnetic field with supply frequency (50/60 Hz) acc. to IEC 61000-4-8	3 A/m	Not tested as no influence is possible on the device within the specified test level. (see Note B)	Magnetic fields of the mains power frequency should comply with the typical values of a business and hospital environment.

NOTE  $U_T$  is the AC main voltage prior to applying the test levels.

## Guidelines and Manufacturer's Statement - Electromagnetic Interference Immunity

The jaw motion measuring system is intended for use in the electromagnetic environment described below. The customer or user of the jaw motion measuring system should ensure that it is operated in such an environment.

Interference immunity tests	IEC 60601 test levels	Compliance level	Electromagnetic environment guidelines
			Portable and mobile wireless sets should not be used in closer proximity to the jaw motion measuring system, including the cables, than the recommended safety distance, that is calculated on the basis of the formula suitable for the transmitting frequency. <b>Recommended safety distance:</b>
Conducted RF interference quantities acc. to IEC 61000-4-6	3 V <sub>eff</sub> 150 kHz to 80 MHz	3 V <sub>eff</sub>	$d = 1.2\sqrt{P}$
Radiated RF interference quantities acc. to IEC 61000-4-3	3 V/m 80 MHz to 2.5 GHz	3 V/m	$d = 1.2\sqrt{P}$ 80 MHz to 800 MHz
			$d = 2.3\sqrt{P}$ 800 MHz to 2.5 GHz
			With $P$ as the rated output of the transmitter in watts (W) according to the information provided by the manufacturer of the transmitter and $d$ as the recommended safety distance in meters (m). The field strength from fixed RF transmitters as determined by an electromagnetic site survey <sup>a</sup> is less than the compliance level <sup>b</sup> in all the frequencies. Interference is possible in the proximity of devices featuring the following pictograph

NOTE 1 The higher value applies in the case of 80 MHz and 800 MHz

NOTE 2 These guidelines may not be applicable in all situations. The spread of electromagnetic waves is influenced by absorption and the reflections of buildings, objects, and people

a The field strength of stationary transmitters, such as the base stations of mobile phones and land mobile services, ham radio stations, AM and FM radio and TV broadcasters is theoretically not 100% predictable. A site study is recommended to determine the electromagnetic environment as a result of stationary RF transmitters. If the measured field strength at the site of the measuring system exceeds the compliance levels listed above, the JM-measuring system must be monitored to document its proper functionality at every place of application. Additional measures might become necessary, e.g. modifying the orientation or moving the location of the jaw motion measuring system, if unusual performance characteristics are observed.

b The field strength is less than 3 V/m for the frequency range of 150 kHz to 80 MHz

## Recommended Safety Distances between Portable and Mobile RF Telecommunications Devices and the JMANalyser jaw motion measuring system

The jaw motion measuring system is intended for use in an electromagnetic environment where RF interference quantities are controlled. The customer or user of the jaw motion measuring system can contribute towards preventing electromagnetic emissions by complying with the minimum distance between portable and mobile RF telecommunications devices (transmitters) and the jaw motion measuring system, as recommended below in accordance with the maximum output power of the communication device.

Rated output of the transmitter (W)	Safety distance based on the transmitting frequency (m)		
	150 kHz to 80 MHz $d = 1.2\sqrt{P}$	80 MHz to 800 MHz $d = 1.2\sqrt{P}$	800 MHz to 2.5 GHz $d = 2.3\sqrt{P}$
0.01	0.12	0.12	0.23
0.1	0.38	0.38	0.73
1	1.2	1.2	2.3
10	3.8	3.8	7.3
100	12	12	23

The safety distance for transmitters with a rated output not listed in the table above, can be calculated by applying the formula corresponding to the respective column, whereby  $P$  is the rated output of the transmitter in watts (W) as specified by the transmitter manufacturer.

NOTE 1 For calculating the recommended safety distance of transmitters in the frequency range of 80 MHz to 2.5 GHz, an additional factor of 10/3 was used to reduce the probability of a mobile/portable telecommunications device taken unintentionally into the patient's area, causing interference.

NOTE 2 These guidelines may not be applicable in all situations. The spread of electromagnetic waves is influenced by absorption and the reflections of buildings, objects, and people.