

Specifications and Operating Instructions



FDM SYSTEM zebris

Inhalt

1	USER NOTES	4
1.1	INTRODUCTION	4
1.2	MANUFACTURER AND SALES	5
1.3	LAYOUT OF THE USER MANUAL FOR THE FDM SYSTEM.....	5
1.4	CONVENTIONS AND SYMBOLS USED	6
2	SCOPE AND SECURITY	7
2.1	INTENDED USE	7
2.1.1	Indications	7
2.1.2	Contraindications	7
2.2	SAFETY.....	8
2.2.1	Environmental conditions	8
2.2.2	Storage and Transport	8
2.2.3	User Obligations.....	9
2.2.4	General safety instructions	10
3	PRODUCT DESCRIPTION	11
3.1	SYSTEM COMPONENTS	11
3.2	TECHNICAL SPECIFICATIONS FDM MEASURING SYSTEMS.....	11
3.2.1	FDM Sensor	11
3.2.2	FDM platforms for stance and roll over analysis.....	12
3.2.3	FDM system for jump analysis.....	13
3.2.4	FDM system for stance and gait analysis	14
3.2.5	FDM platforms for gait training and rehabilitation applications	16
3.3	MEASURING PRINCIPLE	17
3.4	CONTROLS AND CONNECTORS.....	18
3.5	STATUS INDICATOR LED	18
3.6	ZEBRIS SYNC	19
3.6.1	Synchronization input (SYNC-IN)	20
3.6.2	Synchronization output (SYNC-OUT)	21
3.6.3	Synchronizing the FDM Platform with video data (Sync Audio)	22
3.6.4	Infrared synchronization with zebris DAB- Bluetooth (EMG).....	23
3.6.5	Combine two FDM platforms off he same type.....	24
3.7	SPARE PARTS FDM SYSTEM	25
3.8	ACCESSORIES FDM MEASURING SYSTEM	25
4	VIDEO-MODULE	28
4.1	SYNCCAM	28
4.2	SYNCLIGHTCAM	29
4.3	LED VIDEO LIGHTS (SYNCLIGHT / SYNCLIGHT PLUS)	32
4.3.1	SYNCLight	33
4.3.2	SYNCLight plus.....	34
4.3.3	Power Supply Unit SYNCLights	35
5	OPERATION OF THE FDM SYSTEM	37
5.1	SET UP THE MEASURING SYSTEM	37
5.2	HOW TO SWITCH THE PLATFORM ON/OFF	37
5.3	ANSCHLUSS DES MESSSYSTEMS AN DAS VERSORGUNGSNETZ.....	38
5.4	COMPUTER REQUIREMENTS	40
5.5	INSTALLING THE ZEBRIS FDM SOFTWARE	40
5.6	CLOSING THE SAFETY LOCK OF THE PLUG TRAY.....	41
5.7	SETTING THE SYSTEM OUT OF OPERATION	41
5.8	RECOMMENDATIONS FOR RECORDING DATA.....	42
5.8.1	Walking range	42
5.8.2	Data recording.....	42
5.8.3	Gait velocity.....	42
5.8.4	Posture.....	42
5.8.5	Acrosclerosis.....	42

6	CONTROL MEASURES, PREPARATION, DISPOSAL	43
6.1	MANDATORY PERIODIC INSPECTIONS AND STK	43
6.2	CHECKING THE FDM SENSOR	44
6.2.1	Control measures	44
6.2.2	Calibration measures	44
6.3	TROUBLESHOOTING	45
6.4	CLEANING AND DISINFECTION	46
6.4.1	Cleaning	46
6.4.2	Manuelle Desinfektion	46
6.5	DISPOSAL	47
6.5.1	Packaging	47
6.5.2	Disposal of electronics	47
7	SAFETY STANDARDS AND SYSTEM CLASSIFICATION	48
7.1	CLASSIFICATION ACC. TO ANNEX IX OF DIRECTIVE 93/42/EEC	48
7.2	SAFETY OF MEDICAL ELECTRICAL DEVICES	48
7.2.1	Connecting the FDM-System to other electrical devices	48
7.2.2	Vicinity of the patient / test person	49
7.2.3	Use of multiple sockets	50
7.3	ELECTROMAGNETIC COMPATIBILITY GUIDELINE & MANUFACTURER DECLARATION	51
7.4	DECLARATION OF CONFORMITY MEDICAL PLATFORMS	54

1 User Notes

1.1 Introduction

Welcome to the User Manual for the zebris FDM measuring system.

This User Manual provides a basic understanding for operating the FDM measuring system. It provides essential information for the set up of the system and suggests basic principles for preparing the measuring procedure and data recording.

zebris Medical GmbH does not assume any liability for injury to personnel or patients, nor damage to the device caused by improper use of the FDM measuring system for gait and stance analysis.

All data about the measuring system FDM within this user manual has been collected, compiled and checked with the greatest possible care. Nevertheless a User Manual may remain subject to printing errors, faults and changes. Therefore we should like to point out that zebris Medical GmbH neither guarantees nor holds the legal responsibility or any liability whatsoever for consequences occurring due to incorrect data.

Should you become aware of any errors when using this User Manual, or should you find details that do not conform with your device, please kindly inform us. We shall then correct any possible errors as quickly as possible.

In the interests of continuous product development, the manufacturer reserves the right to carry out improvements to this User Manual and the product described therein at any time and without any further obligation.

Registered trade marks

Several brand names are referred within this User Manual. All these product names are used only for clarity's sake or for editorial reasons and are trademarks belonging to the respective companies. When using the brand names, the trade marks them and also the rights of the respective proprietors remain protected.

The name zebris is a registered trade mark and FDM identifies a product of the company, zebris Medical GmbH.

Copyright

This document and extracts taken from it may on no account be duplicated without the explicit consent of zebris Medical GmbH. The content of this document may on no account be used for purposes that have not undergone approval by zebris Medical GmbH. Any infringement of the copyright is a punishable offence.

© Copyright zebris Medical GmbH

All rights reserved.

1.2 Manufacturer and sales

zebris Medical GmbH

Am Galgenbühl 14
D-88316 Isny im Allgäu
Deutschland

Internet: www.zebris.de

Telephone +49 (0)7562 9726 0

Telefax +49 (0)7562 9726 50

E-Mail info@zebris.de

1.3 Layout of the user manual for the FDM System

The measuring system FDM consists of the force distribution measuring sensor technology as well as the corresponding application software including a PC.

Therefore, the user manual of the FDM measuring system consists of several parts:

1. FDM technical specifications and user manual
2. zebris FDM user manual of the application software
3. User manual of the accessories, like e.g. projector or PC



NOTE

Please closely observe the user manuals with initial operation, use or maintenance as well as transport of the FDM measuring system.

The section FDM technical specifications and user manual primarily contains information on technical data and the operation of the FDM force distribution measuring sensor technology as well as on their safe operation.



WARNING

The exact adherence to the instructions in all sections of the operating Instructions for the measuring system is a precondition for its intended use.

1.4 Conventions and Symbols Used



The green markings in the margin of the User Manual denote new information about the product safety.

“**WARNING**” symbols indicate a potential hazard to the health and safety of the users and/or patients. The warnings describe the risks involved and those can be avoided.



“**NOTE**” symbols indicate a potential risk which could lead to damaging of the device. These NOTE symbols describe the risks involved and how those can be avoided.



The **CE mark** on the type plate confirms the conformity of the measuring system with the Directive 73/23/EEC and Directive 89/366/EEC (Low Voltage Directive and EMC Directive).



The **CE mark with reference number 0535** of notified body BSI (formerly EUROCAT) on the type plate confirms the conformity of the system with the Directive 93/42/EEC for Medical Devices.



Symbol for manufacturer and date of production.



Device of type BF according to DIN EN 60601-1



Symbol for the connection of the external power supply unit (DC voltage 15-20V with indicated polarity)



USB-Interface



The symbol indicates that in accordance with the Directive 2002/96/EEC (Waste Electronic and Electrical Equipment Directive) and national laws, a product must not be disposed of in the household waste, and that within Europe it has to be disposed of in a special way.



Carefully read the accompanying documentation, particularly all information concerning product safety

REF
SN

Item number of the measuring system / accessories

Serial number of the measuring system



2 Scope and security

2.1 Intended Use

Main function of the force distribution measurement system FDM is the spatially resolved force distribution measurement under human feet for the analysis of static and dynamic strains as well as the individual gait parameters.

Operation as well as data evaluation and storage are software-aided by using a computer. The measuring systems are suitable for the use with patients that are mentally capable of following the operator's instructions without limitations in the period of application.

The patient's weight is limited by the maximum permissible weight of the treadmill. For the application of the FDM-T with children or patients with severe movement disorders, a fall stop safety is strongly recommended.

Professional facilities (medical practices, clinics, scientific institutions, rehabilitation centres, and orthopaedic specialist shops) are specified as application environment.

The application and operation of the system may only be carried out by thoroughly trained qualified personnel such as clinical doctors, physiotherapists, orthopedics which possess the ability to evaluate the output data in medical aspects as a aid for the diagnosis, treatment or patient care and taking into account the clinical history of the patient in the context of other diagnostic tests.

2.1.1 Indications

- Stance and gait analysis of the "normal" as well as the pathological stance and gait.
- Diagnosis support with foot malpositions and foot corrections
- Diagnosis support and therapy of imbalances / incorrect gait pattern
- Detection of inappropriate mechanical stress and overstraining for the prevention of physical problems and for rehabilitation with disabilities after injury, accidents or surgeries.
- Support with the development, adjustment and verification of orthopaedic aids for the individual patient care
- Balance analysis and balance training
- Gait training in combination with dynamic visual stimulation (cueing) and feedback training as therapy/rehabilitation measures after a surgery, stroke, with the Parkinson's disease as well as other neurologic and orthopaedic disorders
- Success control of therapy/rehabilitation measures

2.1.2 Contraindications

- The FDM system must not be applied for a barefoot measurement with patients having open wounds and/or infections on the feet.

2.2 Safety

2.2.1 Environmental conditions

FDM Measuring Systems are suitable for application in dry interiors with level ground such as those in hospitals, doctors' surgeries and laboratories.

Temperature range	10°C to 40°C
Relative humidity	30% to 70%



WARNING

FDM systems must NOT be operated in wet zones, wet rooms (swimming pools, saunas) or climatic chambers.

Direct contact with liquids must always be avoided, as the measuring system is not protected against the entering of liquids. Liquids entering the device can cause fire, electrical shock or other severe accidents.

The FDM system is NOT specified for the operation in vacuum, hyperbaric or altitude chambers.

The measuring systems are not intended for operation in potentially explosive atmospheres of medically used rooms or oxygen-enriched atmospheres.

The devices must not be operated in proximity to e.g. engines or transformers with a high connected load as well as mains current lines, as electrical or magnetic interference fields can falsify correct measurements resp. turn them impossible.

2.2.2 Storage and Transport

Storage and transport of the measuring system are only to be effected in the original packaging provided by zebris.

Storage temperature	-20°C to +70°C
Relative humidity	5% to 90%
Air pressure	700 hPa to 1060 hPa

2.2.3 User Obligations



- The relevant, general guidelines and/or national laws, national regulations and technical rules for the commissioning and the operation of medical products must be applied and fulfilled corresponding to the indicated purpose of the zebris product. In Germany, operators, device in-charge persons and users are obliged to operate their devices in consideration of the MPG-regulations.
- Users are obliged to:
 - ✓ observe all safety guidelines of the user manual.
 - ✓ carry out any inspection and maintenance works on a regular basis as stipulated in the user manual.
 - ✓ only use work equipment that is free of defects.
 - ✓ check the functional safety and the proper condition of the device before operating.
 - ✓ make all user manuals that are included in delivery and part of the measuring system accessible to all users at all times and keep the manuals in close proximity of the measuring system.
 - ✓ protect him-/herself, the patient or third parties against dangers.
 - ✓ avoid a contamination through the product.
- When using the system, national legal regulations must be observed, in particular:
 - ✓ the valid industrial safety regulations.
 - ✓ the valid accident prevention.
- For the safety, reliability and performance of the components delivered by zebris, responsibility is assumed, if:
 - ✓ assembly, extensions, re-settings, changes or repairs were carried out through zebris or third parties authorised by zebris, trained technicians or employees of authorised dealers. Storage and transport are only to be effected in the original packaging delivered by the manufacturer.
 - ✓ the device is operated in accordance with the user manual.
 - ✓ in case of repair, the regulations of the VDE 0751-1 “Recurrent test and test before commissioning of medical electrical equipment – general regulations” are fully complied with.
 - ✓ the components of information technology provided by the operator correspond to the technical requirements of hard and software included in this user manual and also were installed and set up according to the relevant descriptions in this user manual.
 - ✓ the set-up room corresponds to the given environmental conditions of the measuring system and the valid installation regulations.
 - ✓ the FDM system including accessories is connected to the mains socket with a protective grounding conductor and is operated with the correct mains voltage.
 - ✓ exclusively the software provided by zebris as well as the components and accessory parts listed in this user manual are used together with the system.

2.2.4 General safety instructions



- The application and operation of the system and also the evaluation of the measuring data and their interpretation may only be carried out by trained qualified personnel. The manufacturer assumes no liability for any injury to persons, damage to property, or loss of data due to improper use of the software, the device or its component parts.
- The patients' data and measuring data may only be copied, moved, or deleted using the data-base function provided by the zebris application programs. In the case of data being changed intentionally without using the database functions, the user alone bears the full risks involved.
- Measurement and analysis results should always be interpreted in the light of the clinical history of the patient and in the context of other diagnostic tests by a trained person proven and tested for their relevance.
- Should any measures for treatment be taken on the basis of the measuring results, the measuring system may only be implemented as a supplementary means for evaluation by an expert. On no account can, or may invasive measures, or measures endangering the patient be carried out solely on the basis of the measuring results without further verification of the measuring data by additional methods.
- Should there be any detectable damage to the device or component parts, they should be returned to the manufacturer for a safety check. It is not permissible to continue using the device or its component parts, as severe damage and serious injuries - even lethal injuries - may result. The manufacturer or authorized sales partner must always be contacted in all cases of fault or doubt.
- If any fluids should penetrate the device, it is mandatory for the device to undergo a technical, safety test. Damaged plug connections and leads are to be replaced by an authorized service technician. The device must be put out of operation immediately, marked as "Not working" and prevented from being used by removing the mains cable.
- The measuring system must be checked at regular intervals to make sure it is functioning properly. More details on this can be found in the section, "Maintenance of the Device" in this User Manual
- Be sure that all the mains and connection cables are laid safely and that they are protected against stepping on, so that nobody can trip over them. Check all the cables and the connection plug regularly for any damage. Damaged power Supplies and cables have to be replaced before further operation
- Never try to service the measuring system in any other way as described in the provided user manual. When removing the covers, you may expose yourself to lethal voltages or other risks.
- We also point out that if any changes are made to this certified device or its accessories without the prior written consent of zebris, your legal right to operate the device will be nullified.

3 Product description

3.1 System components

In its basic configuration the FDM measuring system consists of the following components:

- FDM platform
- External power supply unit
- USB cable (Type A-A, 3.5 m length)
- zebris application software zebris FDM
- IBM® compatible computer or notebook
- User Manual for platform and software, equipment and zebris FDM Software

3.2 Technical specifications FDM measuring systems

3.2.1 FDM Sensor

The sensors of the different FDM system only vary in size of the measuring area, the number of single sensors included in the sensor module and the supported sampling frequency. All other technical data is identical:

Interfaces	USB Synchronization input/output Video synchronization Infrared synchronization
Connection	Interface box on bottom of housing frame
Measuring principle	capacitive force measurement
Operating voltage	16-18V DC
Power consumption	max. 60W (depends on type)
Power supply via external power supply unit	100-240V AC / 50-60Hz
Measuring Range	1-120N/cm ²
Accuracy of the calibrated measuring range	(1-120N/cm ²) ±5% (FS)
Mechanical crosstalk	-25dB
Pressure threshold	1N/cm ²

3.2.2 FDM platforms for stance and roll over analysis

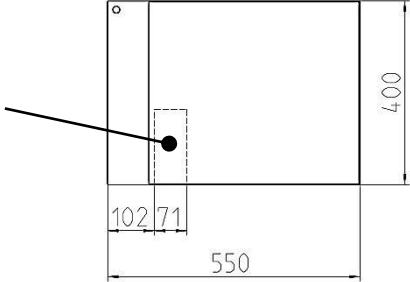
Type	FDM-SX
	<p>Connector box at bottom side</p> 
REF.-No.	01243005
Outer dimensions	550 x 400 x 21 mm (L x W x H)
Weight	ca. 4,8 kg
Measuring frequency	120 Hz
Number of sensors	40 x 48 / 1920
Sensor surface	400 x 330 mm (L x W)
Resolution	1/3 " resp. 1,4 sensors/ cm ²
Infrared interface	optional

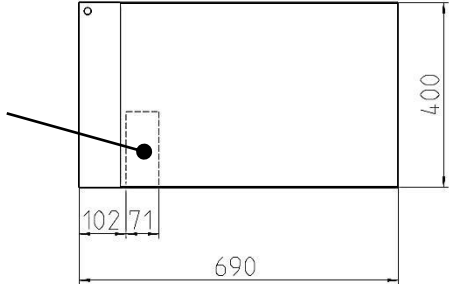
Type	FDM-S
	<p>Connector box at bottom side</p> 
REF.-No.	01243010
Outer dimensions	690 x 400 x 21 mm (L x W x H)
Weight	ca. 6,5 kg
Measuring frequency	100 Hz / optional 240 Hz
Number of sensors	40 x 64 / 2560
Sensor surface	540 x 330 mm (L x W)
Resolution	1/3 " resp. 1,4 sensors / cm ²
Infrared interface	optional

3.2.3 FDM system for jump analysis

Type	FDM-J1.0
------	----------

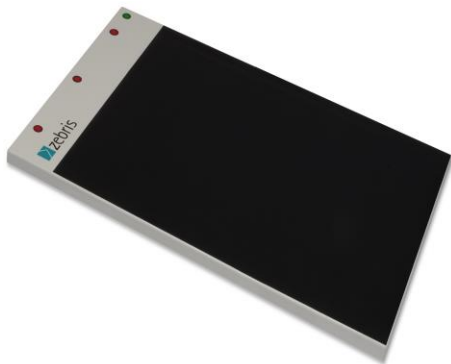

Connector box at bottom side

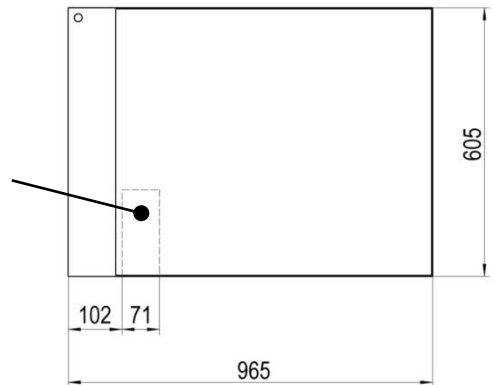

REF.-No.	01243200
Outer dimensions	965 x 605 x 21 mm (L x W x H)
Weight	approx. 12 kg
Measuring frequency	400 Hz / optional 800 Hz
Number of sensors	60 x 64 / 2560
Sensor surface	810 x 510 mm (L x W)
Resolution	1/2 " resp. 0.6 sensors / cm ²
Infrared interface	integrated

Geben Sie hier eine Formel ein.

Type	FDM-J1.8SQ
------	------------



REF.-No.	01243210
Outer dimensions	1810 x 1940 x 21 mm (L x W x H)
Weight	approx. 50 kg
Measuring frequency	100 Hz
Number of sensors	96 x 96 / 9216
Sensor surface	1730 x 1730 mm (L x W)
Resolution	3/4 " approx. 0.3 sensors / cm ²
Infrared interface	integrated

3.2.4 FDM system for stance and gait analysis

Type **FDM-1.5**

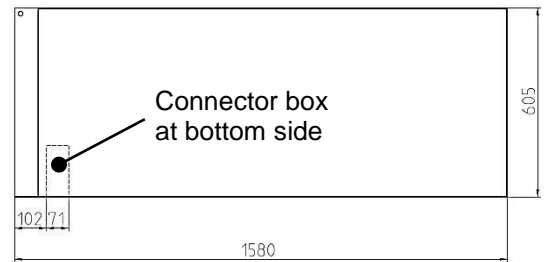

REF.-No.	01243015
Outer dimensions	1580 x 605 x 21 mm (L x W x H)
Weight	ca. 16,5 kg
Measuring frequency	120 Hz / optional 200 Hz oder 300 Hz
Number of sensors	64 x 176 / 11264
Sensor surface	1440 x 560 mm (L x W)
Resolution	1/3 " resp. 1,4 sensors / cm ²
Infrared interface	integrated

Type **FDM-2**

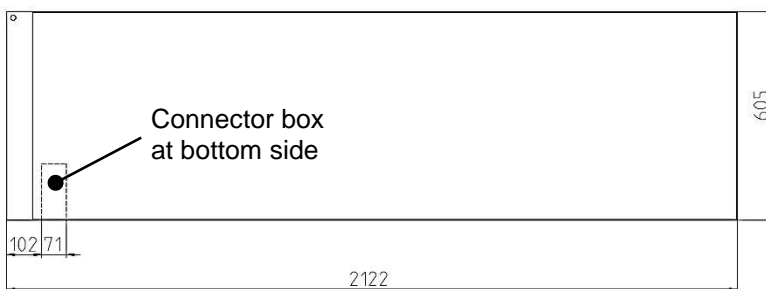
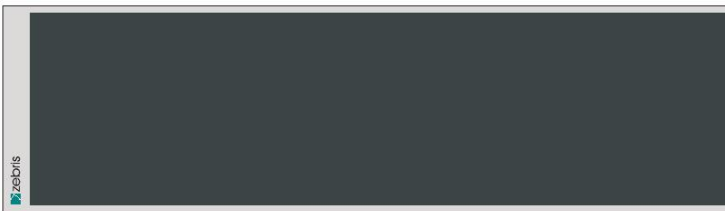

REF.-No.	01243020
Outer dimensions	2122 x 605 x 21 mm (L x W x H)
Weight	approx. 25 kg
Measuring frequency	120 Hz / optional 200 Hz oder 300 Hz
Number of sensors	64 x 240 / 15360
Sensor surface	2030 x 560 mm (L x W)
Resolution	1/3 " resp. 1,4 sensors / cm ²
Infrared interface	integrated

Type**FDM-3**

REF.-No.	01243030
Outer dimensions	3070 x 605 x 21 mm (L x W x H)
Weight	approx. 35 kg
Measuring frequency	100 Hz
Number of sensors	64 x 352 / 22528
Sensor surface	2980 x 560 mm (L x W)
Resolution	1/3 " resp. 1,4 sensors / cm ²
Infrared interface	integrated

3.2.5 FDM platforms for gait training and rehabilitation applications

Ready for installation
in h/p/cosmos parawalk



Type **FDM-1.7**

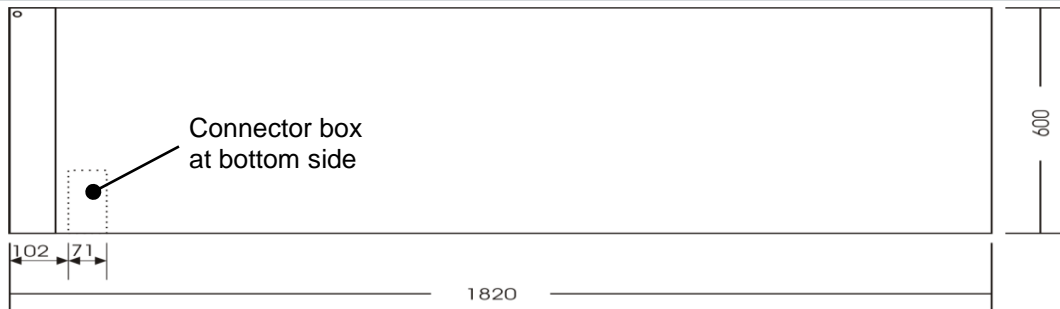

REF.-No.	01243034
Outer dimensions	1820 x 600 x 21 mm (L x W x H)
Weight	approx. 22 kg
Measuring frequency	100 Hz
Number of sensors	44 x 136 / 5984
Sensor surface	1730 x 560 mm (L x W)
Resolution	1/2 " resp. 0.6 sensors / cm ²
Infrared interface	optional

Type **FDM-2.4**

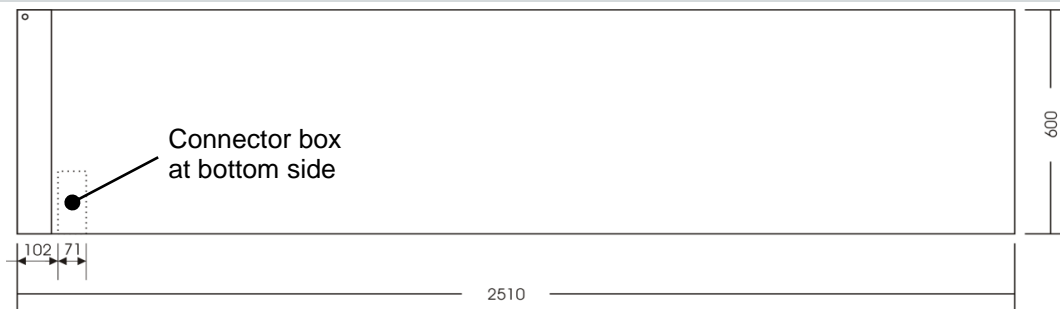

REF.-No.	01243035
Outer dimensions	2510 x 600 x 21 mm (L x W x H)
Weight	approx. 31 kg
Measuring frequency	100 Hz
Number of sensors	44 x 190 / 8360
Sensor surface	2410 x 560 mm (L x W)
Resolution	1/2 " resp. 0.6 sensors / cm ²
Infrared interface	optional

3.3 Measuring principle

The system contains a measuring matrix consisting of capacitive pressure sensors that are arranged in columns and lines running closely next to each other. For determining the force distribution over the measuring matrix the capacity proportional to the force exerted is determined for each individual sensor. To do this, the drive logic generates a number of sinus burst signals equivalent to the number of columns via the column decoder, and transmits them to the respective measuring column. The analog signal coupled into the shift register over the lines is proportional to the pressure-dependent capacity and is passed on for further processing to the control and signal-processing electronics and transmitted to the PC from there and shown on the display.

Schematic circuit diagram of the measuring system

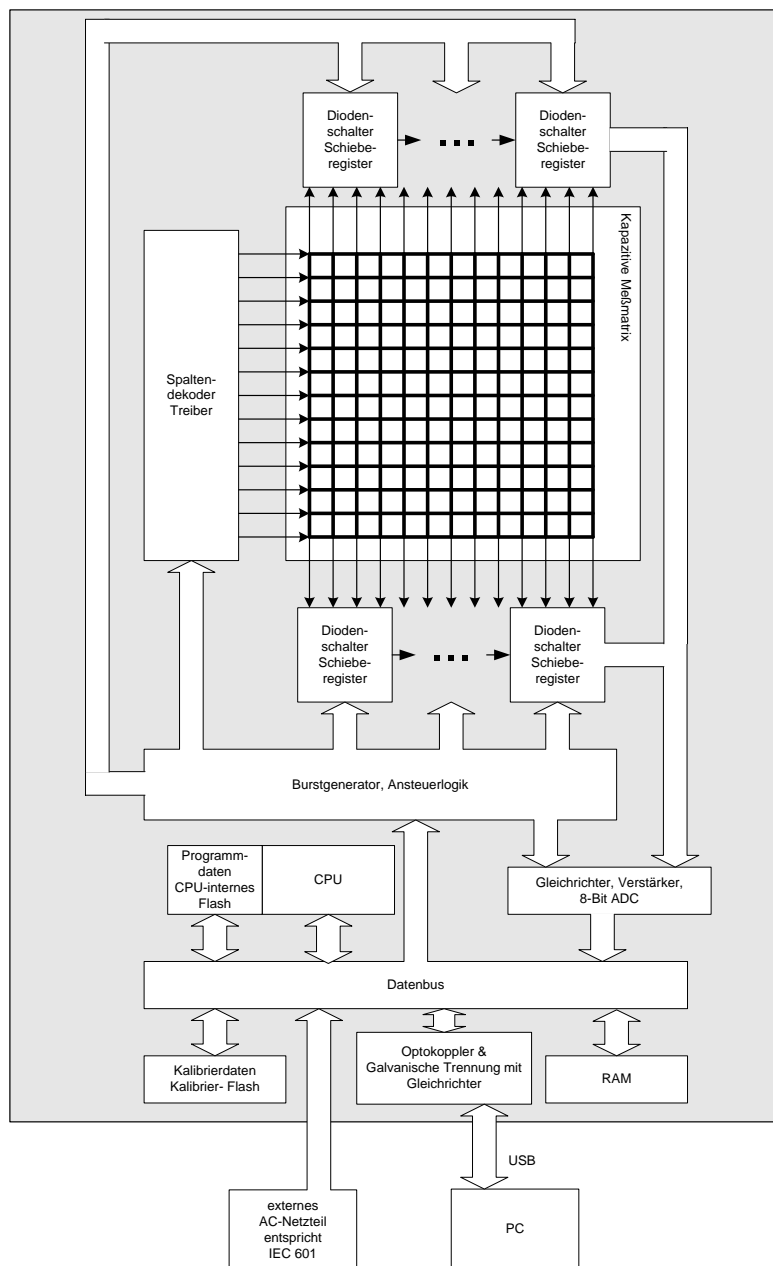

3.4 Controls and Connectors

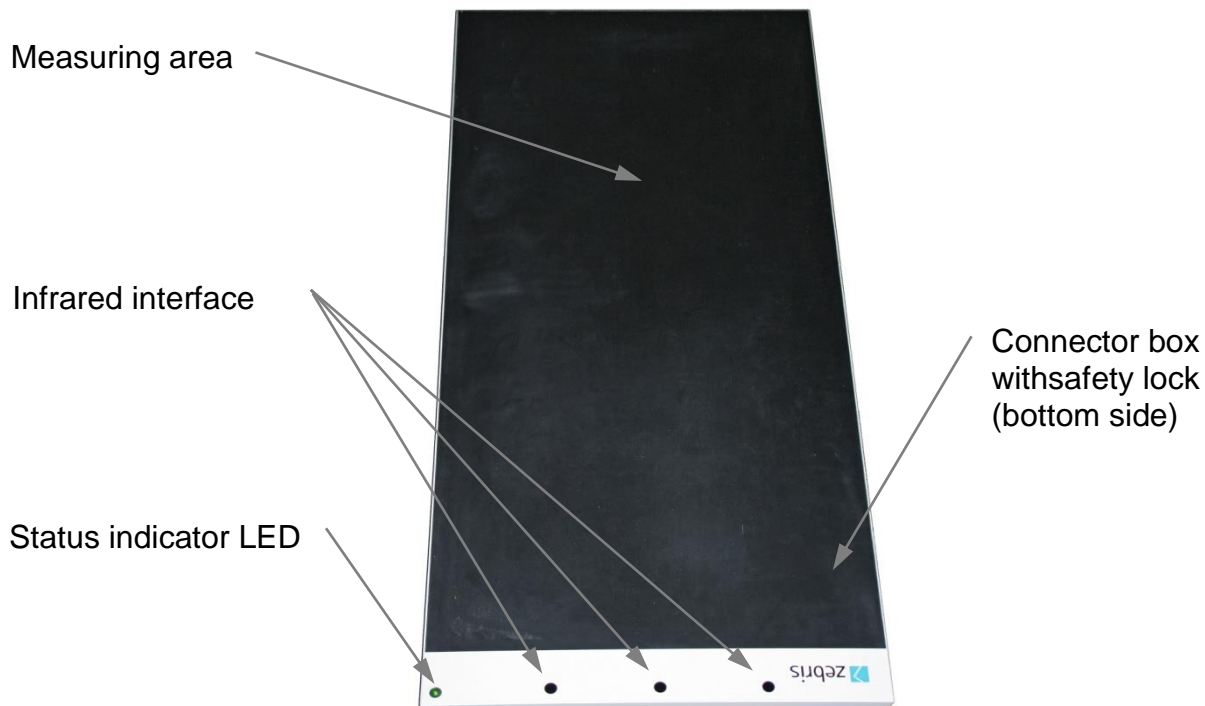

All cable connections between platform and PC will be established by the connector box located at the bottom of the platform.

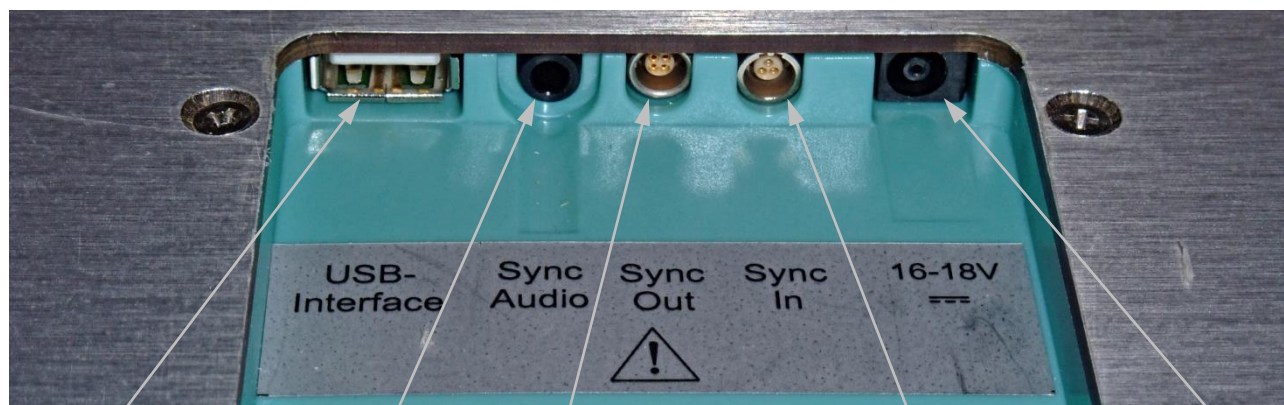

USB-socket Video-Sync Sync Out/Master Sync In/Slave Powersupply

3.5 Status indicator LED

- green flashing** The power supply unit is connected to mains and a correct supply voltage is provided. A USB connection is not established yet or recognized. The platform is not ready for initialization or measurement.
- green permanent** The power supply unit is connected to mains and a correct supply voltage is provided. A USB connection is established and recognized. The platform is ready for initialization or measurement.
- orange permanent** A measurement is in process.
- orange / green flashing** A measurement is in process and infrared synchronization signals (from other zebis devices) are received. The orange flashing signalizes that valid synchronization signals are received.

3.6 zebris SYNC

The **zebris SYNC** serves as a standard solution for the synchronisation of the FDM system with measuring systems of other manufacturers.

The **SYNC-IN** and **SYNC-OUT** sockets provide inputs and outputs for support of „frame by frame“ In- and Out synchronization. Both sockets are galvanic protected from the platform.

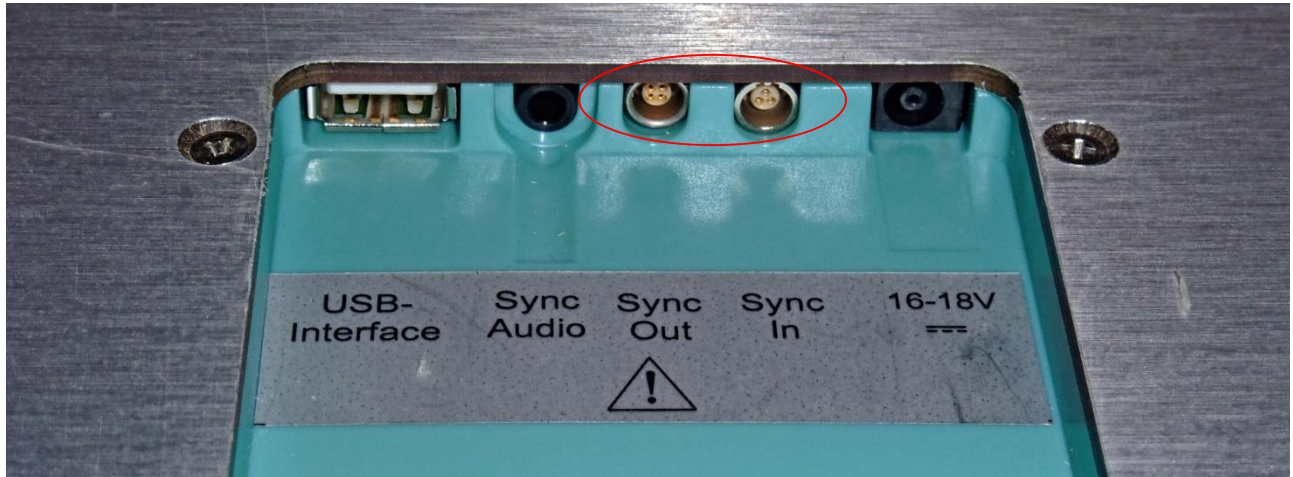

WARNING

Patient's safety is guaranteed by means of galvanic separation acc. to the provisions of IEC 601-1 when a third party device is synchronized with the FDM system. This allows non medical equipment to be synchronized with the FDM system as long as such devices are out of patients reach. Nevertheless the user is completely responsible for the safety of all third party devices used in combination with the FDM system.

The correct synchronisation of the measuring data of all coupled systems must be verified before evaluation as soon as a coupling with devices is carried out, that have not been manufactured by zebris.

zebris does not assume any warranty for the correct functioning and reliability of the system if the clock signals of external devices do not correspond to the indicated specifications.

3.6.1 Synchronization input (SYNC-IN)

If a third party device is connected to the synchronization input SYNC-IN then depending on the setting of the configuration window from the application software the measurement will start/stop or “frame by frame” synchronized by a signal from the third party device. Input is protected against faulty polarisation and pin 1 is set to +5V ("1") by an internal pull-up resistor 2.7 kΩ. If this input is set to 0 V ("0") i.e. by a switch or break contact than the SYNC-IN is triggered.

Electrical specifications

Input resistance (Pull-Up 5V)	2,7kΩ
V _{IH} (High-Level Input Voltage)	≥ 2,0V
V _{IL} (Low-Level Input Voltage)	≤ 0,8V
Required min. pulse time for triggering	1ms

Built-in LEMO – Jack at Front of ZEBRIS Gauge

Series „00“, 3-pin, fitting Nut 30°

LEMO- Part. No. EPA.00.303.NLN



View
Front side

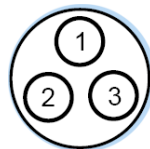

Fitting Nut: 30°



Respective PlugType of plug for SYNC-IN:

LEMO- Part No. FGA.00 303.CLADxxxx



View
Solder side



Fitting Nut: 30°



Pin assignment

Pin 1	Clk_IN
Pin 2	Activ_IN
Pin 3	GND

3.6.2 Synchronization output (SYNC-OUT)

If a third party device is connected to the synchronization output SYNC-OUT then depending on the setting of the configuration window from the application software will trigger a synchronized measurement of the third party device either via start/stop or “frame by frame” mode.

Electrical specifications

Output resistance	100Ω
High-Level	≥ 2,0V
Low-Level	≤ 0,8V

Respective Plug Type of plug for SYNC-IN

Series „00“, 4-pin , fitting Nut 0°

LEMO- Part. No. EPG.00.304.NLN



View
Front side

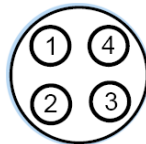

Fitting Nut: 0°



Passender Steckertyp für SYNC-OUT

LEMO- Part. No. FGG.00 304.CLADxxxx

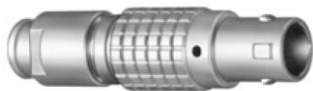

View
Solder side



Fitting Nut: 0°



Pin assignment

Pin 1	+5V
Pin 2	GND
Pin 3	Activ_OUT
Pin 4	Clk_OUT

3.6.3 Synchronizing the FDM Platform with video data (Sync Audio)

The Sync-Audio socket serves for synchronizing the platform measurement and recordings of commercially available video cameras utilizing the external microphone input of the camera.

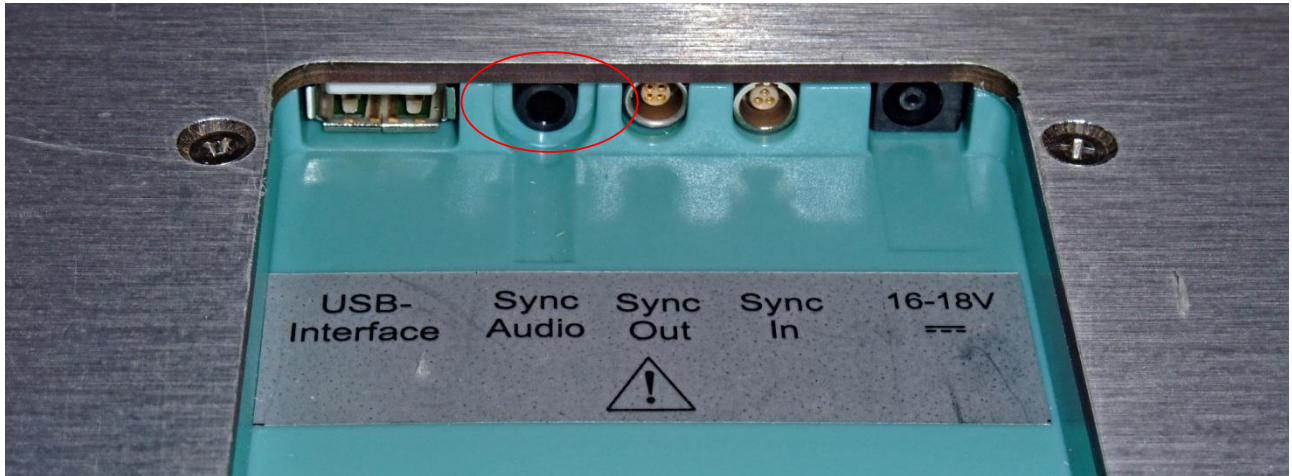

The synchronization is effected by imprinting a tact signal on the soundtrack of the video recording. This data is evaluated automatically by the application software WinFDM for synchronizing the platform data and the video signal.

For the connection to the video camera the following synchronization cable is required:

Item No. 01830016 / Video Sync-Control cable,
cable length 7m with amplifier and control LED.



3.6.4 Infrared synchronization with zebris DAB- Bluetooth (EMG)

For synchronizing the FDM system with the zebris DAB-Bluetooth the optionally available IR interface which will be integrated within the platform housing is required.

FDM platform and DAB-Bluetooth are synchronized automatically as soon as both devices have been switched on and a measurement is started.

The following schematic diagram shows the interconnection of the FDM-platform and the zebris DAB-Bluetooth.

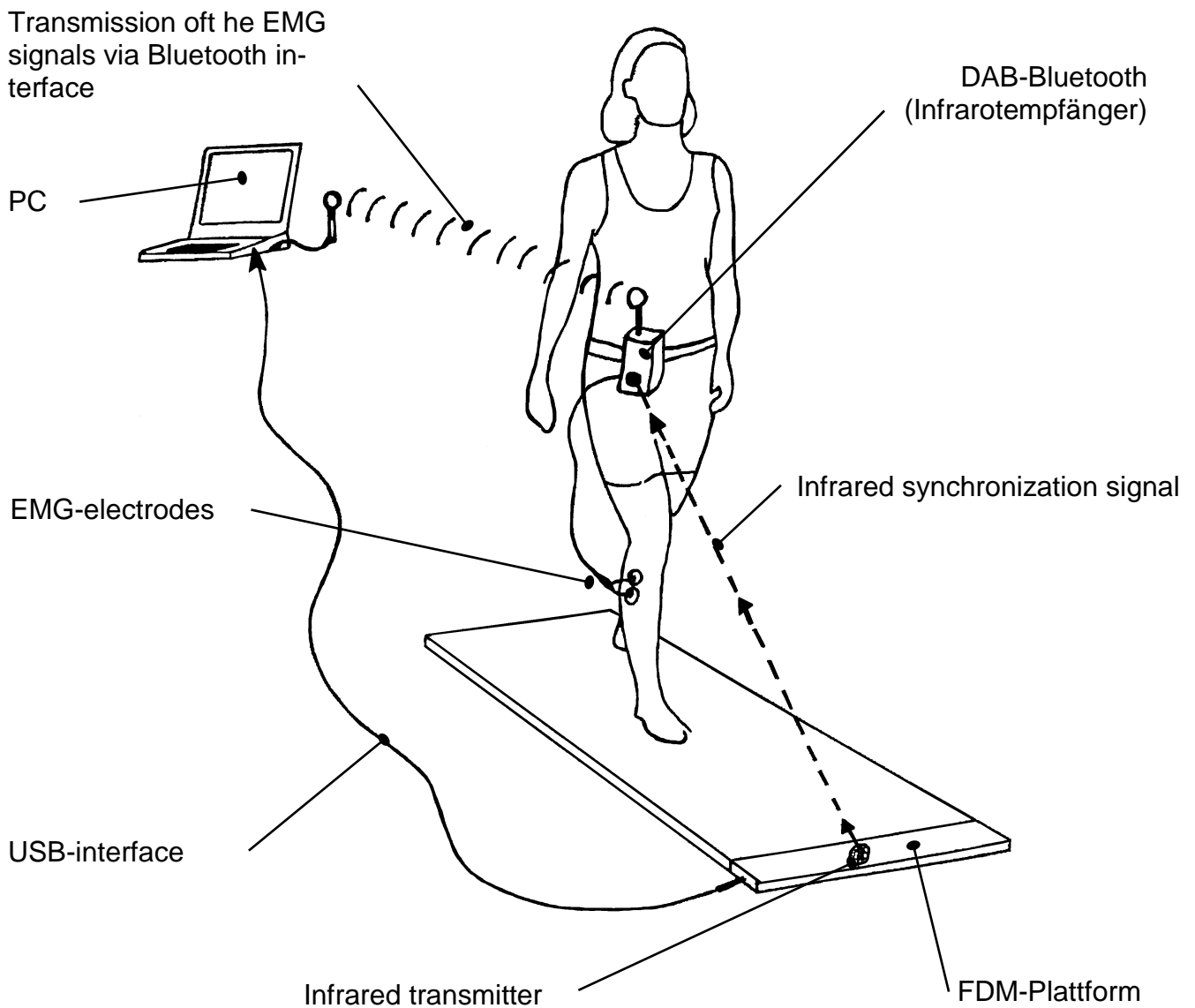

3.6.5 Combine two FDM platforms of the same type

Two FDM platforms of the same type can be combined (Master – Slave) in order to double usable walking range. To accomplish this task a synchronization cable is required.

Item No. 01830019 / SC-PP Sync. Cable, length 10m



Both platforms have to be connected to separate USB ports of the same PC. By means of the synchronization cable the „Sync Out“ socket of the master platform has to be connected to the „Sync In“ socket of the slave platform. The WinFDM software then will recognize the platform combination automatically and show the corresponding sized measuring area.



Be sure to position both platforms as shown below when connecting them for doubling the walking range.



When using the zebris SYNCCam with two combined platforms it must be connected to the “Sync Audio” input of the master platform.

3.7 Spare Parts FDM System

REF- No.	Description	Illustrations
01811513	PS Mascot/2020 Power supply unit 60W/16VDC for FDM 1.5/1.7/2/2.4/3/J sensors equiv. to EN 60601-1 & UL	
01831104	PS MASCOT/2126 Power supply unit 15W/18VDC for FDM SX/S sensors equiv. to EN 60601-1 & UL	
07200010	zebris FDM Software for operating system Windows 7 32/64 Bit	
79010105	Hardware FDM user manual / english Printing version is liable to be charged. Free download of PDF-Files from zebris Service Center:	
79010185	Software zebris FDM user manual / english Printing version is liable to be charged. Free download of PDF-Files from zebris Service Center:	
21030071	USB cable A-B, 3 m long Data connection between interface box and PC	

3.8 Accessories FDM Measuring System

REF- No.	Description	Illustrations
01540191	SYNCCam Camera with USB-Cable, synchronization-cable, tripod, inclusive software extension	

01540194

SYNCLightCam

Combined solution with Camera and illumination, USB-Cable, synchronization cable, tripod, inclusive software extension



21030321

SYNCCam USB-Cable A-B

USB-Cable for HD-video signal with high quality plugs, EMC-shielding and ferrites length 5m



01830016

Video Sync-Control Cable 7.0

Length 7m, both sides phone jack 3,5mm with amplifier and control-LED for DV-camcorder



01830041

Video Sync-Control Cable 2.5

Length 2.5m, both sides phone jack 3.5mm, without amplifier for zebris SYNCCam



21030312

Video Sync-Control Extension Cable

Length 5m, phone jack & socket 3.5mm



01540110

SYNCLight

with 10 power LEDs, power supply unit, light intensity infinitely variable VIDEOSYNC, without tripod



33102220

SYNCLight Power Supply Unit

Mains adapter 40W / 24V DC



01540110

SYNCLight Plus

with 10 power LEDs, power supply unit, light intensity infinitely variable VIDEO SYNC, PULSE SYNC, zebris SYNC up to 3 SYNCLight Plus can be combined into a lighting unit, without tripod.



33102210

SYNCLight plus Power Supply Unit

Mains adapter 110W / 24V DC, Supports up to 3 SYNC Light plus.



01850011 **SYNCLight plus Adapter Cable**
for Master-Slave connection
of up to 3 SYNCLight plus, length 1m



4 Video-Module

4.1 SYNCam

The **SYNCam** is an accessory of the FDM-T system and perfectly adapted to be used in combination with the force distribution measurement. All adjustments of the camera are carried out via hardware setup integrated to the zebris FDM Software. The camera is connected to the PC by a USB cable of type A-B included within the shipment.

The camera is equipped with ¼ inch tripod threads and can be adapted to zebris tripods as well as commercially available camera tripods.

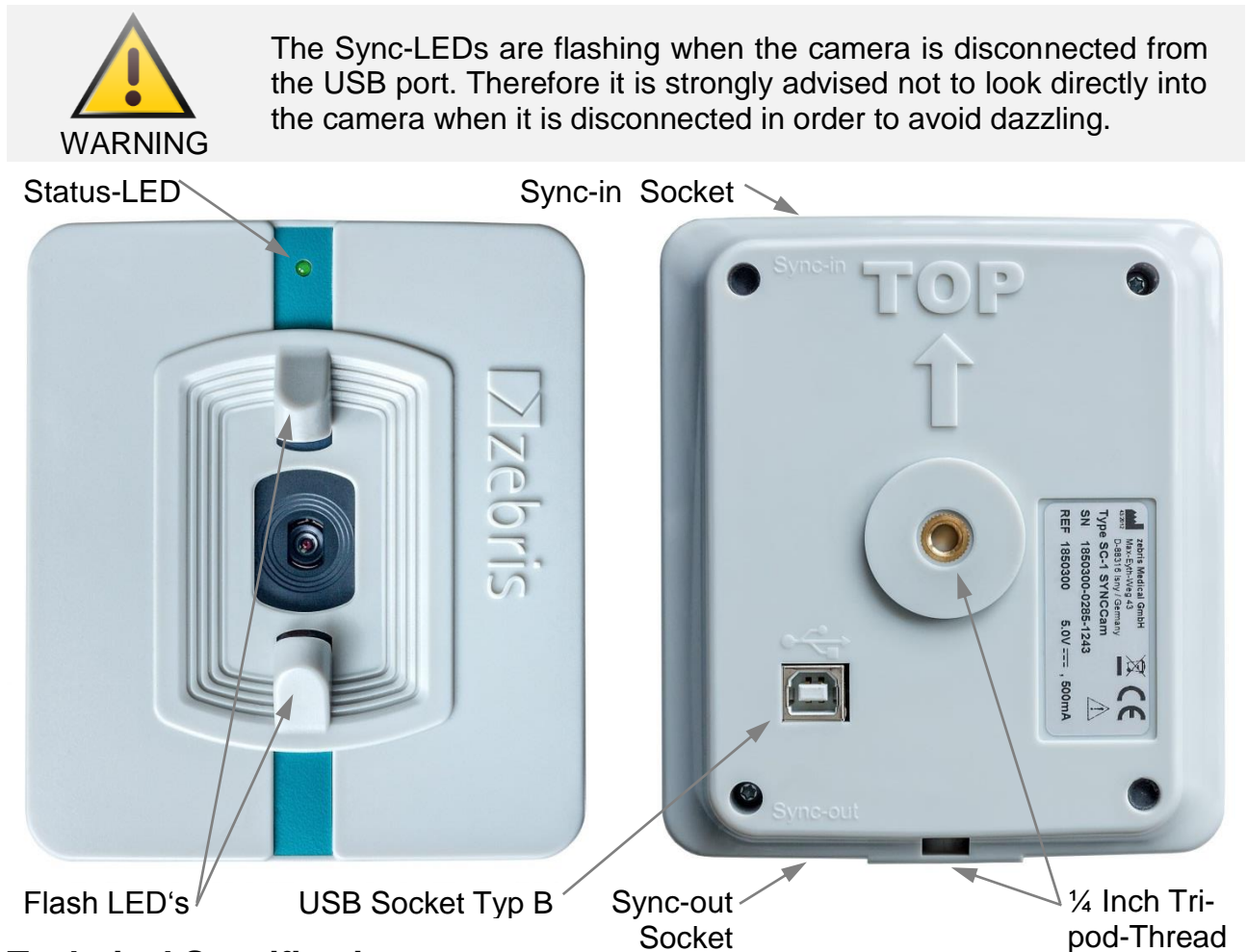

Technical Specifications

REF-No.	01540190
Dimensions	110 x 125 x 15mm (L x W x H)
Weight	approx. 190g
Power Supply	USB (5V DC / 500mA)
Resolution	1920 x 1080 Pixel (Full-HD) / Autofocus
Frame Rate	30Hz
Synchronization	LED-Flash triggered by Sync-IN socket
Mounting	¼ Inch tripod-thread at bottom and back side



NOTE

In order to maintain undisturbed transmission of the video signal it is mandatory to use high quality USB cables.

Please, only use cables supplied or recommended by zebris for connecting SYNCam and PC.

4.2 SYNCLightCam

The **SYNCLightCam** is an accessory of the FDM system and perfectly adapted to be used in combination with the force distribution measurement. All adjustments of the camera are carried out via hardware setup integrated to the zebris FDM Software. The camera is connected to the PC by a USB cable of type A-B included within the shipment.

The **SYNCLightCam** is equipped with ¼ inch tripod threads and can be adapted to zebris tripods as well as commercially available camera tripods.



WARNING

The Sync-LEDs are flashing when the camera is disconnected from the USB port. Therefore it is strongly advised not to look directly into the camera when it is disconnected in order to avoid dazzling.

Furthermore contains the SYNCLightCam as an integral solution, the LED video illumination.

In order to produce well lighted and tack sharp video captures it is essential to maintain perfect lighting conditions at the patient's side. Only with adequate lighting conditions video cameras can work with shutter times short enough to freeze fast movements and capture sharp images.

This solution is perfectly matched on the interaction with the FDM system and can be regulated infinitely in its brightness.

The integrated synchronization unit automatically switches the lights on at the start of a measurement and turns them off again after stopping it.

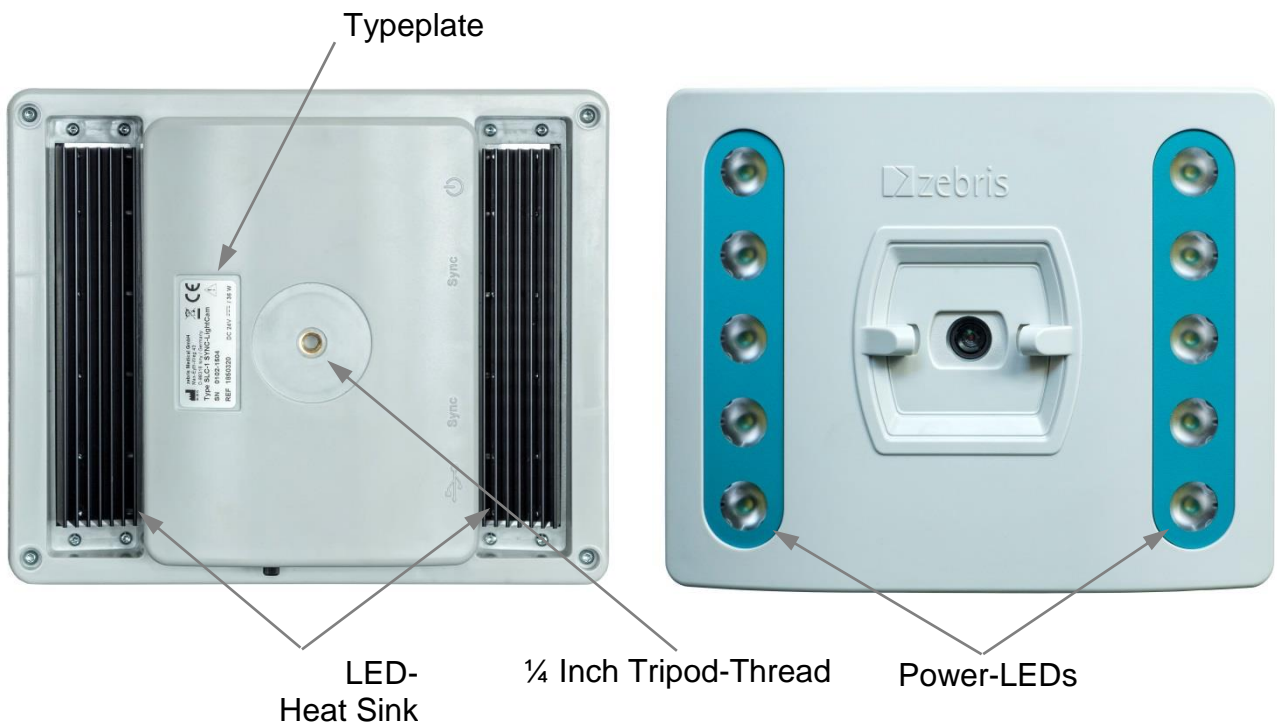

NOTE

In order to ensure failure-free operation of the SYNCLights it is mandatory to keep the black heat sinks at their back side uncovered and well air circulated at all times.

Technical Specifications

REF-No.	01540194
Dimensions	220 x 183 x 80mm (B x H x T)
Weight	ca. 790g
Power Supply	24V / 36W
Resolution	1920 x 1080 Pixel (Full-HD) / Autofokus
Frame Rate	30Hz
Light Colour / Light Synchronization	Current 6200 K / 1550 Lumen VIDEOSYNC (Ein-/Ausschalten mit der Messung) SYNC IN Standard zebris Synchronisation (kompatibel mit SYNC IN/OUT Plattform)
Mounting	¼ Zoll Stativgewinde an der Rückseite

VIDEOSYNC
Sockets (3 mm
Phone Jack) Jack)

Power-
Supply

Status-LED



Status-LED

Light intensity-
Adjustment

SYNC Mode-
Switch

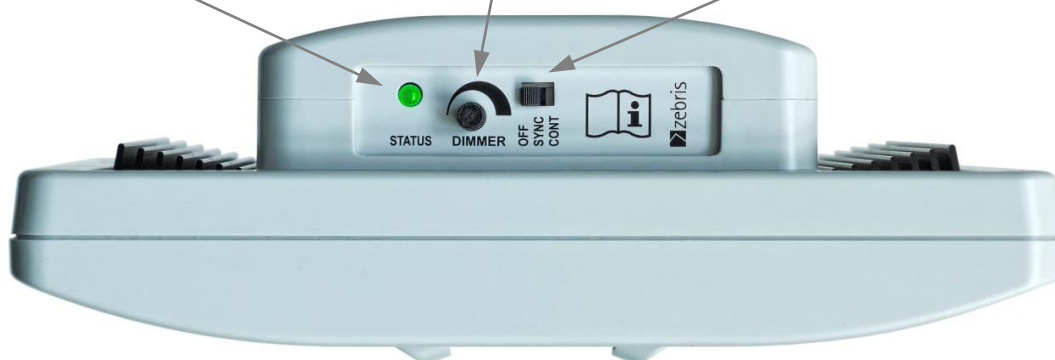

NOTE

In order to maintain undisturbed transmission of the video signal it is mandatory to use high quality USB cables.

Please, only use cables supplied or recommended by zebris for connecting SYNC Cam and PC.

Interpretation of the STATUS-LED

- Green** Device is ready for use or in operation.
- Orange** The orange colour indicates when the maximum operation temperature has been reached. At this point the operation current is reduced automatically (which results in reduced brightness) in order to prevent the SYNCLight plus from being damaged by excessive heat.

Power Supply Unit

For operation of the SYNCLight plus a power supply unit needs to be connected.

REF-No. 33102220

Input	Output	Cable	Length
100 – 240 V AC	24 V DC	DC-Lead	1.7 m
50 – 60 Hz	40 W	Mains Lead	Plug Adapter

SYNC-Modus

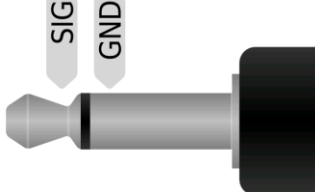
Modes	Characteristics	Pin Assignment
VIDEO SYNC IN	ESD - protected, voltage reversal proof input Input resistance: 38 k Ω (AC) Signal-Level: AC Trigger Level: 15 mV	

4.3 LED Video Lights (SYNCLight / SYNCLight plus)

In order to produce well lighted and tack sharp video captures it is essential to maintain perfect lighting conditions at the patient's side. Only with adequate lighting conditions video cameras can work with shutters times short enough to freeze fast movements and capture sharp images.

The LED video lights **SYNCLight** and **SYNCLight plus** are accessories of the FDM systems and perfectly adapted for use in combination with zebris **SYNCCam** as well as the force distribution measurement. Their brightness can be adjusted infinitely.

The integrated synchronization unit automatically switches the lights on at the start of a measurement and turns them off again after stopping it.

Both SYNCLights are equipped with ¼ inch tripod threads and can be adapted to zebris tripods as well as commercially available camera tripods

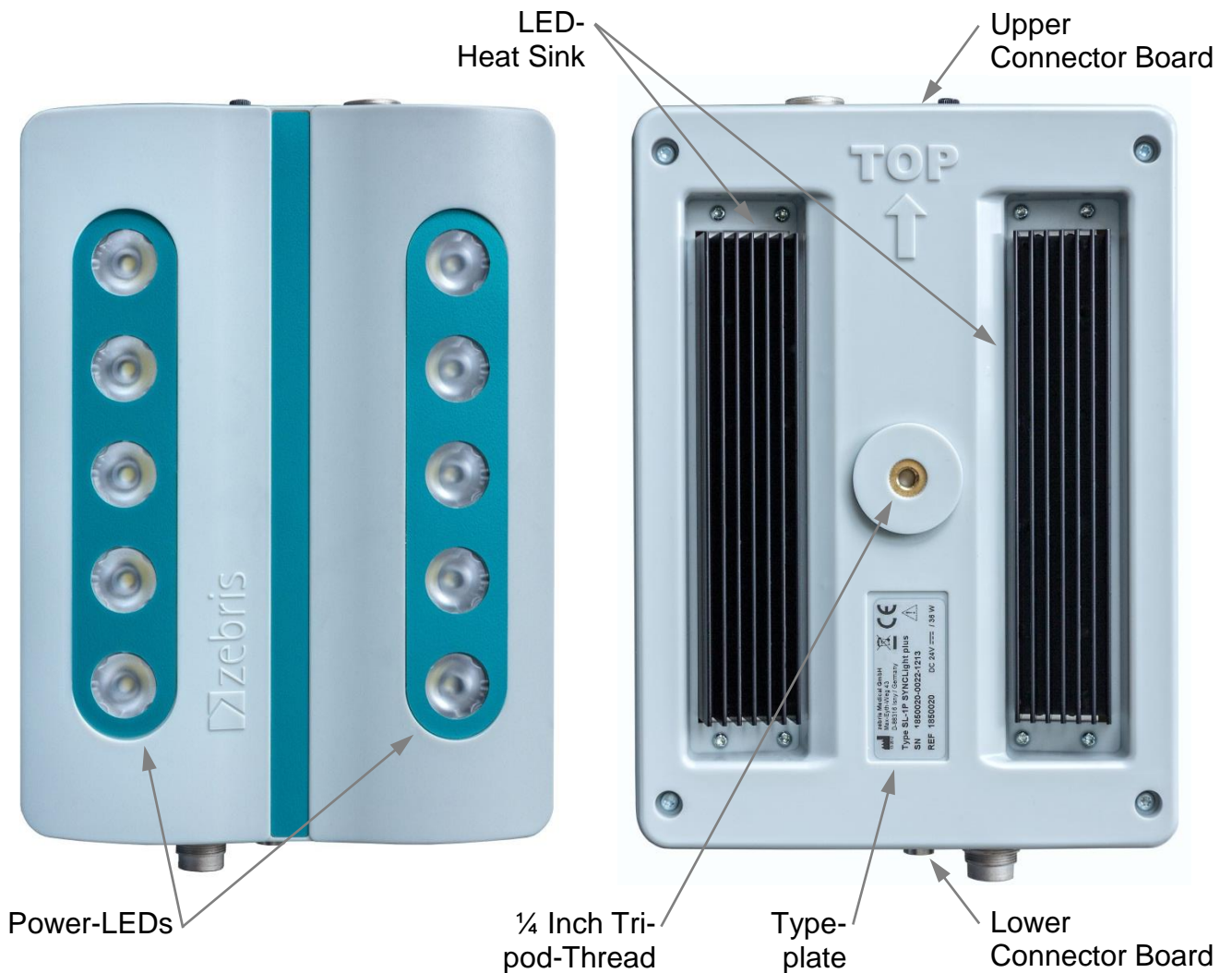

NOTE

In order ensure failure-free operation of the SYNCLights it is mandatory to keep the black heat sinks at their back side uncovered and well air circulated all the time.

4.3.1 SYNCLight

If the synchronization signal from the interface box of the FDM-T system is connected to the **VIDEOSYNC** socket the SYNCLight will be automatically turned on and off when a measurement is started or stopped.

In order to use the synchronization set the **SYNC-Mode switch** to position SYNC. At position **CONT** the SYNCLight plus is switched on permanently. The **DIMMER** can be used to adjust the light brightness individually no matter which operation mode is set.

Technical Specifications

REF-No.	01540110
Dimensions / Weight	155 x 210 x 38mm (L x W x H) / approx. 640g
Power Supply	24V DC / 36W
Light Colour / Light Current	6200K / 1550 Lumen
Synchronization	VIDEOSYNC (On-/Off with force measurement)
Mounting	¼ Inch tripod thread at back side

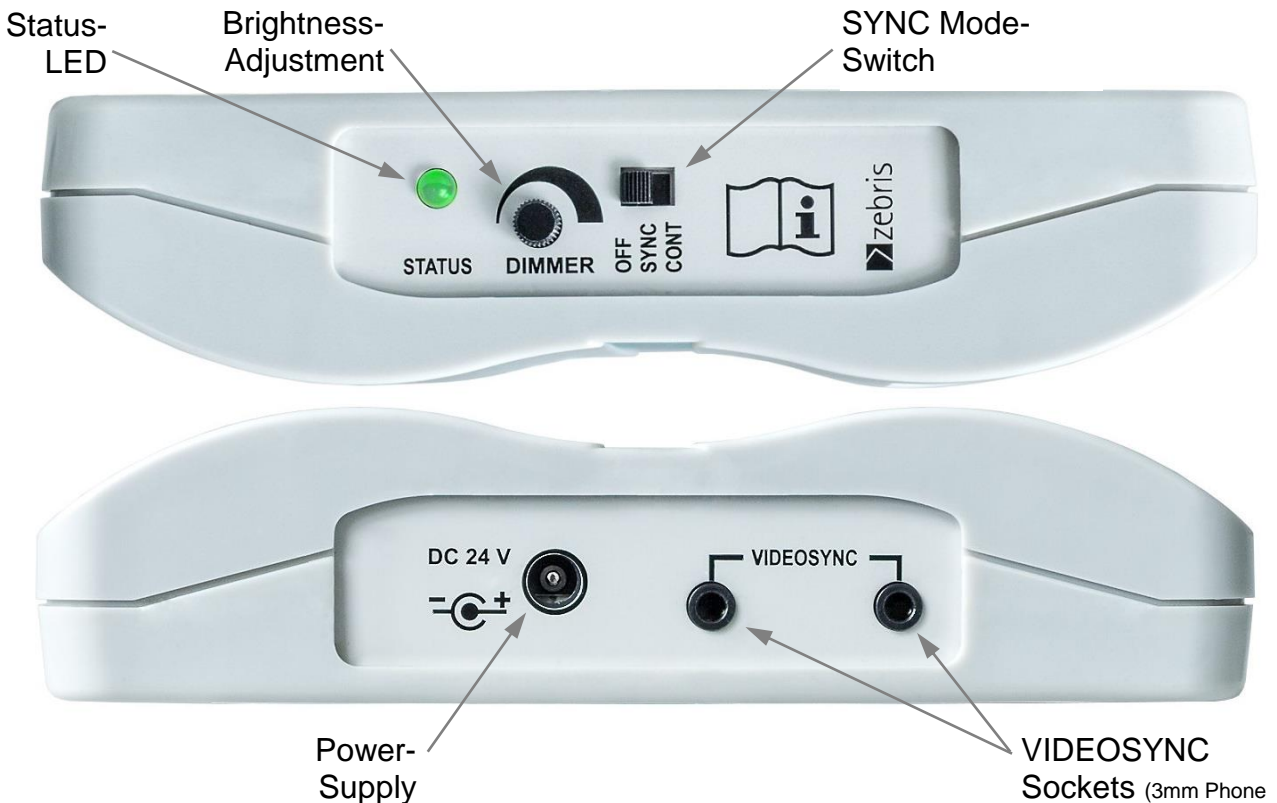

Interpretation of the STATUS-LED

- Green** Device is ready for use or in operation.
- Orange** The orange colour indicates when the maximum operation temperature has been reached. At this point the operation current is reduced automatically (which results in reduced brightness) in order to prevent the SYNCLight plus from being damaged by excessive heat.

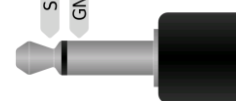

Power Supply Unit

For operation of the SYNCLight a power supply unit needs to be connected.

REF-No. 3310.2220

Input	Output	Cable	Length
100 - 240V AC	24V DC	DC-Lead	1.7m
50 - 60Hz	40W	Mains Lead	Plug Adapter

4.3.2 SYNCLight plus

The SYNCLight plus supports the zebris VIDEOSYNC as well as more complex synchronization modes that may be required for use of industrial cameras.

In order to use the synchronization modes set the **SYNC-Mode switch** to position SYNC. At position **CONT** the SYNCLight plus is switched on permanently. The **DIMMER** can be used to adjust the light brightness individually no matter which operation mode is set.

Up to 3 SYNCLight plus can be combined into a lighting unit. Therefore they have to be connected with an adapter cable. The adapter cable provides power supply as well as transmission for the synchronization signals.

Technical Specifications

REF-No.	01540120
Dimensions / Weight	155 x 210 x 38mm (L x W x H) / approx. 640g
Power Supply	24V DC / 36W
Light Colour / Light Current	6200K / 1550 Lumen
Synchronization	VIDEO SYNC → On-/Off with force measurement PULSE SYNC → Shutter Sync. with industrial cameras SYNC IN → Standard zebris synchronization (Compatible with SYNC IN/OUT platform)
Mounting	¼ Inch tripod thread at back side
Master – Slave Operation	off max. 3 SYNCLight plus by adapter cable 185.0011/SL-C1

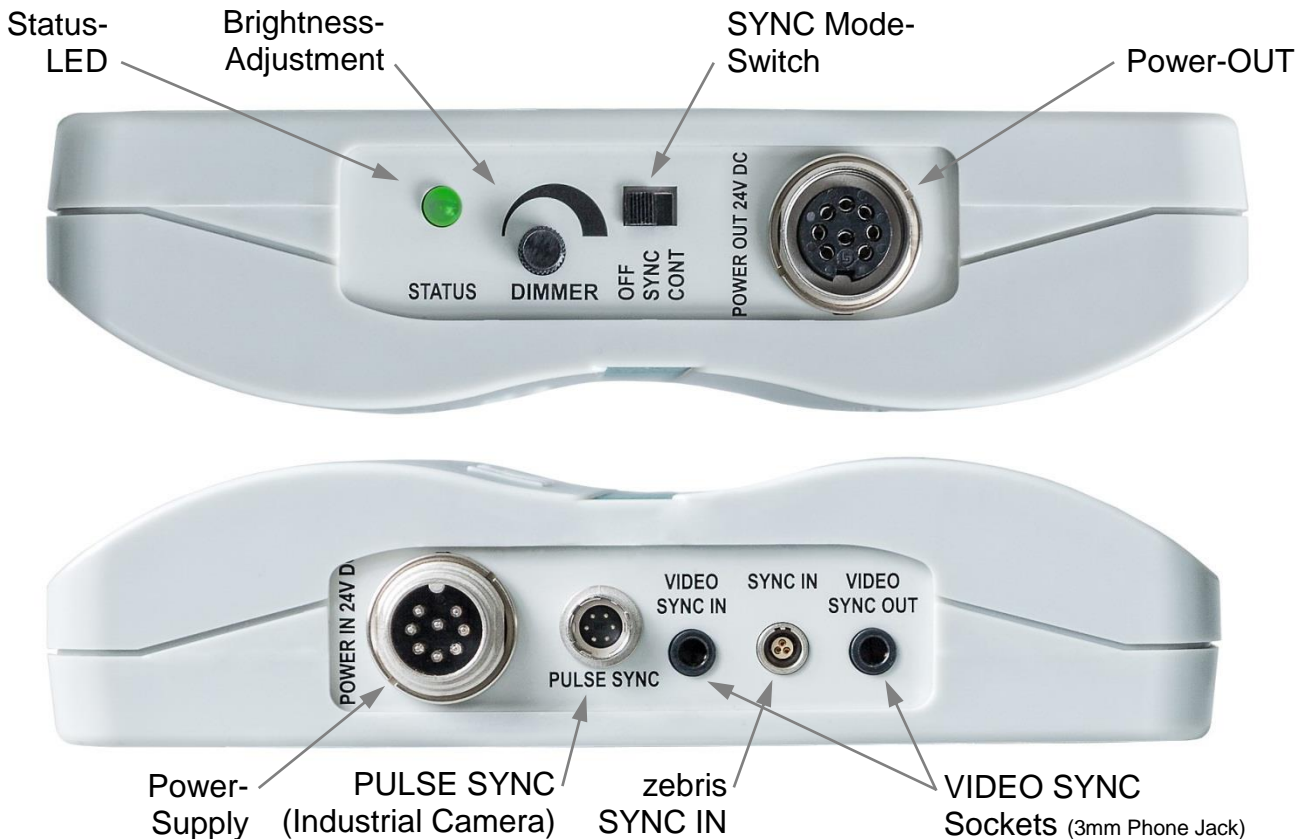

Interpretation of the STATUS-LED

- Green** Device is ready for use or in operation.
- Orange** The orange colour indicates when the maximum operation temperature has been reached. At this point the operation current is reduced automatically (which results in reduced brightness) in order to prevent the SYNCLight plus from being damaged by excessive heat.

4.3.3 Power Supply Unit SYNCLights

For operation of the SYNCLight plus a power supply unit needs to be connected.

REF-No. 33102210

Input	Output	Cable	Length
100 - 240V AC	24V DC	Mains Lead	1.7m
50 - 60Hz	110W	DC-Lead	1.7m

SYNC-Modes

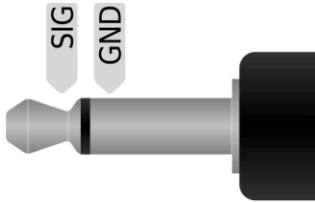
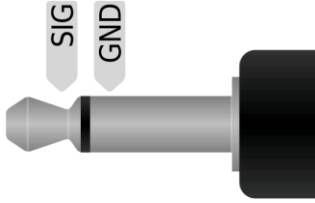
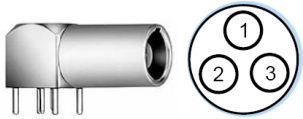
Modes	Characteristics	Pin Assignment
VIDEO SYNC IN	ESD - protected, voltage reversal proof input Input resistance: 38K Ω (AC) Signal-Level: AC Trigger Level: 15mV	
VIDEO SYNC OUT	ESD - protected, voltage reversal proof input The signal from the VIDEO SYNC IN is directly transmitted to VIDEO SYNC OUT and can be used for control of additional devices.	
SYNC IN	ESD - protected, voltage reversal proof input Input resistance: 38K Ω (Pull-Up) V_{IH} (High-Level Input Voltage): $\geq 3.7V$ V_{IL} (Low-Level Input Voltage): $\leq 3.0V$ Both Signals can be used as Trigger input ("AKTIV" as well as "CLK") and possess the same effect. The signal switches the LED light on to the brightness level pre-selected by the DIMMER The SYNC IN is the standard synchronization tool (zebris SYNC) of all zebris measuring systems and intended to be used to synchronize the lighting system with the measuring signal of other zebris measuring systems (e.g. CMS). In order to use SYNC IN the SYNC mode switch has to be set to position SYNC .	 3-Pin Socket Pin1: CLK Pin2: AKTIV Pin3: GND Socket Type LEMO- Part No. FGA.00 303.CLADxxxx

Modes Characteristics

PULSE SYNC

ESD - protected, voltage reversal proof input
 Input resistance: 2KΩ (Pull-Up)
 VIH (High-Level Input Voltage): 2.0V
 VIL (Low-Level Input Voltage): 0.8V
 Polarity: Lo Active

When mode PULSE SYNC is used LED brightness is set to 150%.

The shutter output of industrial high speed cameras can be used as trigger signal for the PULSE SYNC.

By utilizing pulsed light optimal lighting conditions for industrial cameras can be accomplished without being too bright or disturbing for the human eyesight.

In order to use PULSE SYNC the **SYNC mode switch** has to be set to position **SYNC**.

Pin Assignment

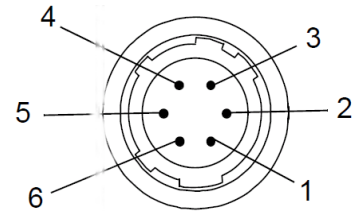

6-Pin Socket

Pin4: Input
 Pin5: GND

Socket Type

HIROSE HR10A-7P-6S

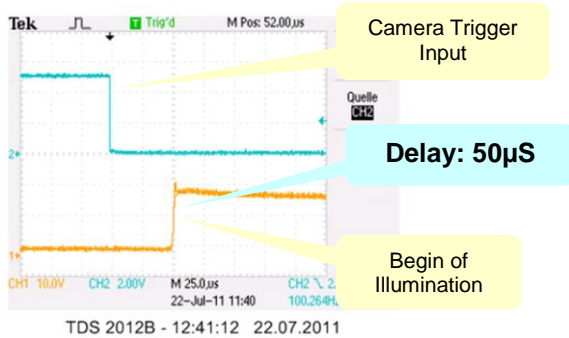

Timing Properties when switching the Light **ON**:

Delay of 50µS

The cameras Trigger-Output should be preset to this Value.

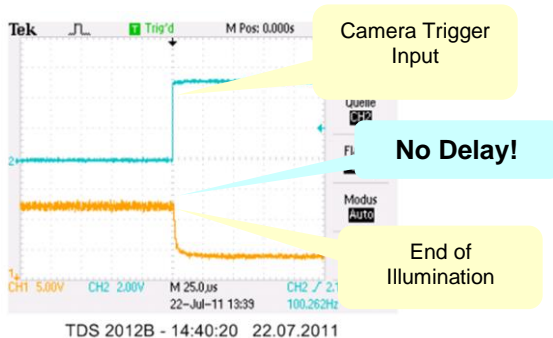

Timing Properties when switching the Light **OFF**:

No Delay (0µS)

No adjustment of Trigger-Output necessary!

5 Operation of the FDM System

5.1 Set up the measuring System

For the commissioning of the FDM platform the suitable power supply, a USB cable type A-A as well as the installation CD with the FDM application software are necessary. All components are included in the scope of delivery of the FDM measuring system.

- The underground of the set-up location must be plain and horizontal.
- The platform must be set up on a slip-proof underlay or installed in a catwalk, so as to exclude any danger to the test person caused by the platform sliding.
- Do not set up the platform near a source of heating or in direct sunlight in front of a window as a rise in temperature can lead to inaccurate measuring results.
- Set-up the measuring system in a way, that the socket for the mains connection is accessible easily at all times and that the device can be separated from the power supply.
- Once the measuring system is set up safely and horizontally, it can be connected to the power supply and put into operation.



WARNING

Be sure that all the mains and connection cables are laid safely and that they are protected against stepping on, so that nobody can trip over them. Check all the cables and the connection plug regularly for any damage.

The cables therefore can be laid under a cable protection or fixed to the floor using a tape if necessary.

5.2 How to switch the platform On/Off

The platform is switched on and off by software control as soon as the zebris FDM software on the PC is started. If the device has been connected correctly, the green LED operating indicator illuminates on the housing of the platform.

5.3 Anschluss des Messsystems an das Versorgungsnetz

For the connection of the FDM platform with the mains, connect the power supply with the mains socket and the power socket in the connector compartment.



WARNING

Exclusively use the power plug approved by zebris for the operation of the FDM platform, which is suitable for the power supply of your platform.

Power Supply MASCOT/2126

REF-No. 01831104

For the following platforms:

FDM-SX
FDM-S

Technical Data

Input	Output	Cable	Length
100 - 240 V AC	18V DC	AC Cable	---
50 - 60 Hz	15 W	DC Cable	6m

Pin arrangement / polarity



Pin arrangement and polarity is identically to Mascot/2020

For the following platforms:

FDM-1.5, FDM-2, FDM-3
FDM-1.7, FDM2.4
FDM-J1, FDM-J1.8SQ

Technical Data

Input	Output	Cable	Length
100 - 240 V AC	16V DC	AC Cable	1,7 m
50 - 60 Hz	60 W	DC Cable	5 m

Pin arrangement / polarity

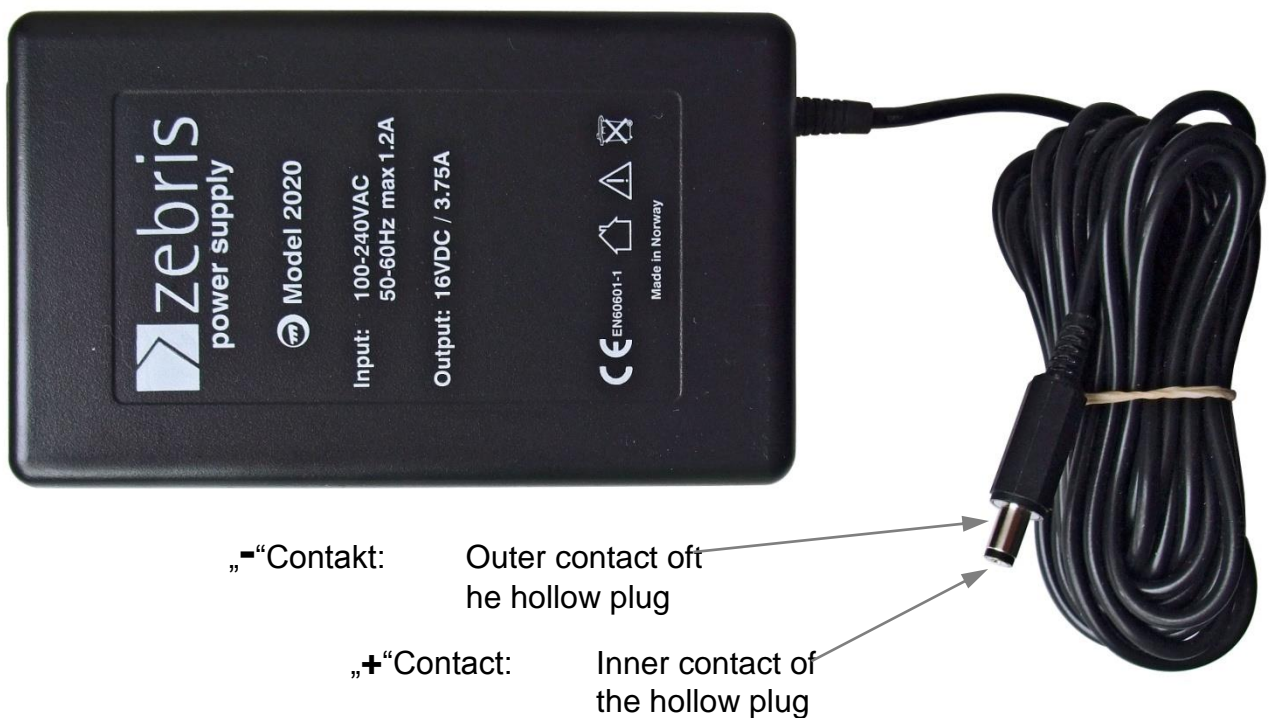

NOTE

Before connecting the measuring system to the mains, compare the nameplate indications of the power supply and the treadmill in terms of mains voltage and mains frequency with the local characteristics. Only connect when they are in accordance.



WARNING

Carry out a visual examination of power supply, mains connection voltage and socket as well as earthing contacts before connecting resp. commissioning the measuring system. Damaged power supplies, cables or connection sockets immediately must be replaced by a person authorised to do so.

5.4 Computer requirements

As a rule, the measuring system FDM is supplied together with a computer. If the system is to be operated using other computers or components, the user must then inquire whether the intended coupling guarantees the necessary safety for the test person, the operator and the surroundings by consulting the manufacturer, the authorized zebris sales partner or by asking a specialist.

Please refer to the zebris FDM Software Manual for informations according to PC requirements.



WARNING

If the computer is not supplied with the measuring system, the manufacturer shall not be held liable for any damage or malfunctions arising from a faulty coupling. Should additional hardware be built into the computer or software installed, the manufacturer shall not be liable for any malfunctions or damage occurring.

The computer must be CE marked and fulfil the requirements of DIN EN 60950 resp. DIN EN 60601-1.



WARNING

The FDM measuring system is not designed for the operation within a network/data network. The connection of the system with a network/data network can cause unforeseen risks for patients or third parties. If the zebris FDM software shall be installed in a network/data network, the operator is obliged to determine, analyse, evaluate and control the risks that are connected with doing so – particularly with regard to the aspects data protection, virus security, updates of the operating system and regular backups. Risk considerations have to include subsequent changes of the network/data network, like e.g. update/upgrade of devices and components that are connected to the network.

5.5 Installing the zebris FDM software

If your measuring system is delivered without PC/laptop, please install the application software before connecting the measuring system to the computer. Please find information on the installation in the user manual of the zebris FDM software.



NOTE

Please make absolutely sure that you have installed the zebris software before connecting the FDM platform to the computer using the USB cable.

If the platform is connected without installing the software before, problems when installing the device driver may occur and the system does not work.



NOTE

How to solve problems with the hardware driver

Should problems with the hardware driver of the FDM platform occur then disconnect the platform from the PC and restart it. Now proceed with installing the WinFDM software another time and reconnect the platform when the installation procedure has been finalized.

5.6 Closing the safety lock of the plug tray

Finally connect the USB socket in the connector compartment and a free USB interface of your computer by using the provided USB cable. Your measuring system is now ready for use. The control of a measurement exclusively is carried out via the zebris FDM software. Therefore, please carefully read the zebris FDM user manual.

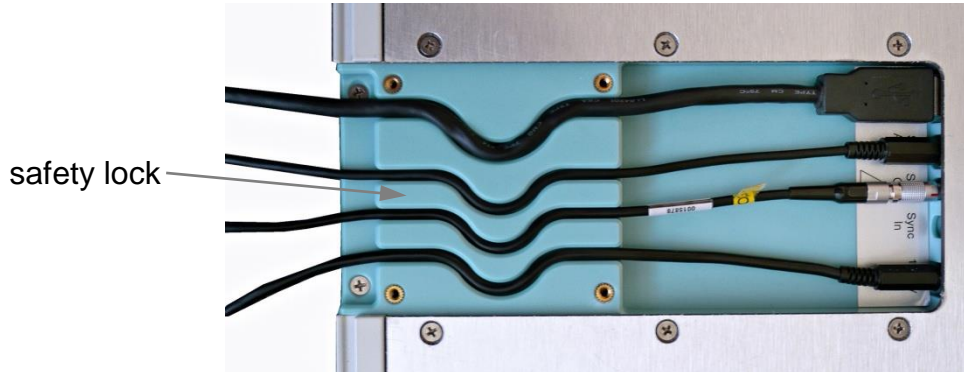

If the power supply unit and the USB cable are connected to the sockets of the platform, please close the lid of the safety lock and fasten it to the housing by means of the four screws supplied with the platform.

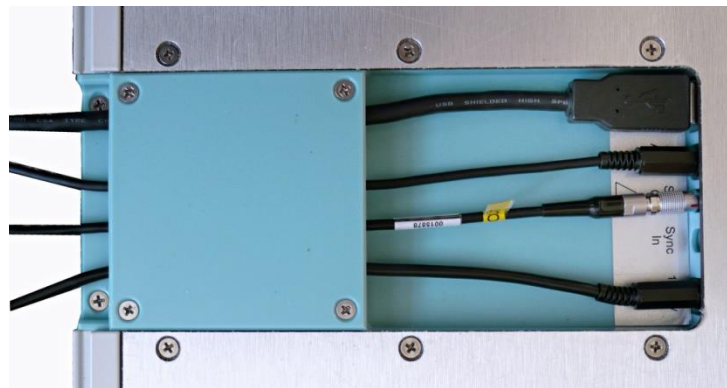

5.7 Setting the system out of operation

In order to set the system out of operation please close the WinFDM software first, then exit the Windows operating system and shut down the PC. In the next step disconnect the power supply unit of the FDM sensor and the treadmill from mains supply.

5.8 Recommendations for recording data

To receive significant data from FDM systems some principle guidelines should be followed. This chapter describes the ideal conditions for recording measurement data: The following points refer to the data reception of a person walking and describe the ideal measurement situation.

5.8.1 Walking range

The best conditions for measurements with platforms of the FDM-S type will be reached by integration of the system in a walking range. The complete walking range must be plane with the surrounding floor. This way the test person won't know the position of the platform and gives a workaround to the tendency that test persons try to walk exactly on the sensor area. The width of the stage should be about 1,20m. We recommend a distance of about 4m from start to FDM-S platform and no less than 3m behind. With such a walking stage it is easier to measure normal walking without acceleration or deceleration.

Of course the same set up can be used to measure with the method of first step. The first step method is described as follow: The patient stands on one side of the platform in a distance to reach the platform by the first step. For measurement the patient hits the sensor area by the first step and moves on. This kind of measurement guaranties reproducible steps and results. Notice: These results differ more or less from these by normal walking.

5.8.2 Data recording

Please observe the exercise of the patient strictly. Only steps where the complete ground contact of the foot is located on the sensor area may be used for evaluation. If not the complete foot area was measured by the system (foot did partially not hit the sensor area) the step can not be evaluated.

5.8.3 Gait velocity

For the measurement a normal (individual) and constant walking velocity is necessary. Ideally an additionally measurement, e.g. by photo sensors, can proof the velocity for notice. Naturally the patients adapt to the measurement situation within a few minutes. After a few trials, walking seems normal. A change in velocity of about 5 % is non-effective.

5.8.4 Posture

A visual control of the behaviour pattern of normal gait is recommended. Trials with atypical behaviour pattern should be deleted from interpretation. The patient has to look straight ahead and must not be disturbed by paying attention to the platform or monitor. Marks on the wall in front of the patient can provide orientation to hit the platform.

5.8.5 Acrosclerosis

Different measurements (e.g. P.R. Cavanagh, *The Foot* (1994) 4, 123-135) show an increase of plantar pressure peaks of about 30 % by acrosclerosis (e.g. weals). The interpretation of measurement data has to include the existence of plantar acrosclerosis.

6 Control measures, Preparation, Disposal



- Scheduled maintenance of the system is essential in order to prevent damage and guarantees the safety of the device. All methods concerning the system's maintenance and disinfection mentioned in this user manual should be carried out on a regular basis.
- Should any malfunctions and/or defects be determined or suspected, the device must be put out of operation immediately, marked as "Out Of Service" and prevented from being used by removing the mains cable. In such case be sure to contact the manufacturer or an authorized sales partner.
- The maintenance of the device or its accessories, going beyond the procedures described in this user manual, must exclusively be carried out by zebris Medical GmbH or a person who has been explicitly authorized by zebris to do this.
- Be sure to switch off the measuring system and disconnect it from mains supply before starting any maintenance work.

6.1 Mandatory periodic inspections and STK



- The zebris Medical GmbH does not stipulate any safety-related control for the FDM system.
- For maintaining the correct state of the electrical equipment, checks and technical safety inspections have to be carried out repeatedly (e.g. within Germany, acc. to BGV A3, and accident prevention regulations and technical safety tests according to the Medical Device Operating Regulations). Here it should be noted that standard regulations for electrical devices are concerned here and not measures that are specific to zebris.
- For safety reasons it is recommended before each use of the measuring system, to check the correct state of all the connection leads, as well as the mains cable, mains plug and mains socket. Should certain parts be damaged, these must be replaced before continuing to use the measuring system.
- Immediate maintenance measures are to be carried out if:
 - a) Fluid enters the device
 - b) Cable or cable connections have been damaged
 - c) Parts of the sensors were damaged
 - d) Covers have been damaged
 - e) A malfunction or a fault is suspected or has been detected
- If the type plate or other important labels (warning notices) are damaged or obliterated they have to be replaced by the manufacturer for safety reasons.

6.2 Checking the FDM Sensor

6.2.1 Control measures



WARNING

The measuring system must be checked at regular intervals to ensure that the measuring system is functioning properly.

Should any damage to the measuring surface become evident (e.g. something fell hard on the black measuring surface), no further measurements must be taken. If visible damages are detected no further measurements are permitted.

After carrying out a baseline measurement, no measuring values may be shown for a condition without any load. In addition, the force distribution images are to be checked regularly for untypical measuring patterns. These include above all, line or column-shaped measuring patterns deviating from the surrounding values.

Whenever faults occur or in case of doubt, the manufacturer or sales partner authorized by zebris must always be contacted.

6.2.2 Calibration measures

The measuring accuracy of the sensors for the force distribution measurement is to be checked from time to time using a defined application of force.

To do this, the user, knowing the body weight, can stand on the platform on one foot. The platform must show the approximate body weight, taking the force of gravity, the sensors at the edges that may not be subject to the full pressure, and the measuring tolerance into consideration.

In case of deviations larger than $> \pm 5\%$ of max range a recalibration at manufacturers side is required.

Should the display be incorrect, a recalibration by the manufacturer is required.

6.3 Troubleshooting

Please check the following points if technical malfunctions should occur:

- ✓ Is the FDM platform properly connected to the mains?
(LED flashes green)
- ✓ Is the USB connection between platform and the measuring PC properly connected?
(LED flashes green when the USB port and the power supply are connected to the PC and the device driver has been installed correctly.)
- ✓ Are all further components of the measuring system (infrared synchronisation with zebris DAB-Bluetooth, video camera) properly connected?



NOTE

Please find further information on error messages and troubleshooting in the user manual of the zebris FDM software.

Checklist for the reception of error messages



NOTE

In order to support you the best way possible in case of malfunction of your FDM measuring system, our service employees need the following information:

- ✓ Device type + serial number of the FDM platform
Please find the serial number on the left-hand side of the platform close to the connector compartment.
- ✓ Version of the zebris FDM software
- ✓ Version of the operating system of your measuring PC
e.g. Windows 7 Professional Servicepack 1
(Call under Windows 7: Windows Start button → Control Panel → System)
- ✓ Further components being connected to the measuring system
e.g. Infrared synchronisation (IR) with zebris DAB-Bluetooth, video camera
- ✓ List of all USB devices that are connected to the measuring PC
e.g. mouse, printer, other measuring systems etc.
- ✓ Screenshot of the error message, or exact wording
e.g. "EMG adapter not found."
- ✓ Precise and detailed description of the procedure that has lead to the error message.
e.g. Measurement "Type A" started, then clicked on button "B", afterwards carried out movement "C", switched to function "D", when switching back, the error message xyz occurred etc.

6.4 Cleaning and disinfection

6.4.1 Cleaning

The platform and accessories are cleaned with a moist cloth while the device is switched off and the mains plug taken out.



NOTE

Do not use any aggressive agents to clean the measuring system.



WARNING

Please be absolutely sure to switch off the device and pull the mains plug out of the socket before you commence disinfecting and cleaning.

6.4.2 Manuelle Desinfektion

The platform can be disinfected by wiping over with suitable agents. To clean, wipe the platform with a cloth soaked in disinfection liquid.



WARNING

No spray disinfection!

Spray disinfection can destroy the highly precise measurement sensors of the platform.



Recommended disinfection agent

Composition approx. 25% ethanol, 35% Propanol
E.g. Mikrozyd Liquid / Schülke & Mayr or similar agents



NOTE

If you apply disinfection agent be sure to follow the recommendations given by the manufacturer of the disinfection agent strictly. Especially consider the rules concerning the commended application time of the agent.



WARNING

Due to danger of confusion, chemicals that are necessary for the disinfection or cleansing exclusively must be stored, prepared and provided in containers that are appropriate for this purpose.



NOTE

In order to demonstrate that disinfection was successfully done, it is recommended to put up a sign on the platform, saying "disinfected".

6.5 Disposal

6.5.1 Packaging

All transport packagings delivered by zebris can be recycled within Germany via the local recycling depots. In order to provide the reuse of the recyclable material contained in the packagings, the zebris Medical GmbH takes part in the dual ZENTEK system that takes over the proper disposal of packagings.



6.5.2 Disposal of electronics

This symbol states that according to the directive on waste electrical and electronic equipment (2012/19/EEC) the product must not be disposed by means of the domestic waste system. Within Europe this device must be forwarded to a specific waste disposal system.

Therefore regular disposal is carried out by the manufacturer. For this purpose the system should be shipped to the manufacturer and will be forwarded to regular disposal by zebris.

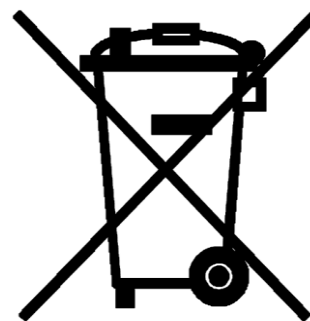

The improper interaction with electronic waste could lead to negative effects for the environment and the public health because of potential hazardous materials which are frequently contained within electric and electronic devices. Additionally with the proper disposal of this product you will contribute to the effective use of natural resources.



Accumulators and batteries

Accumulators and batteries must not be disposed of with domestic waste! In the interest of environmental protection, the consumer is legally obliged (battery regulation) to return old and used batteries. Used accumulators and batteries can be disposed of at the collecting points of the community or where batteries of the relevant kind are sold. For consumers, the batteries are taken back free of charge.

7 Safety standards and system classification

The following information and warnings are listed according to the requirements of the standard DIN EN 60601-1:2006, section 11 for medical, electrical systems and must be applied when operating the FDM system for medical purposes.

7.1 Classification acc. to Annex IX of Directive 93/42/EEC

If your FDM platform features a CE sign on the nameplate with a four-digit identification number of a notified body (0535), the system is then classified as medical product **Class I with measuring function**.

7.2 Safety of medical electrical devices

The FDM platform fulfils the requirements of the standard DIN EN 60601-1:2006.

Classification of the FDM Sensor according to DIN EN 60601-1

Type BF

Safety class II

Steady state conditions

Unsuitable for use in an oxygen-enriched atmosphere

7.2.1 Connecting the FDM-System to other electrical devices

(siehe auch DIN EN 60601-1:2006 Abs. 16 Medizinische Elektrische Systeme)



WARNING

The FDM System may only be coupled with other electrical devices if these conform to the provisions of DIN EN 60950 or DIN EN 60601-1 or zebris Medical GmbH has confirmed their compatibility.



WARNING

When coupling several devices to one measuring station, please note that no danger through summation of leakage currents can occur.

Devices that are in direct contact with the patient and that are commonly used in a medical electrical system, as a whole have to fulfil all requirements of DIN EN 60601-1:2006 section 11.

There is a danger of electric shock when touching devices that are not grounded separately.

7.2.2 Vicinity of the patient / test person

For the definition of the patient's surroundings, experience shows that a value of 1,5 m distance to the patient is optimal.

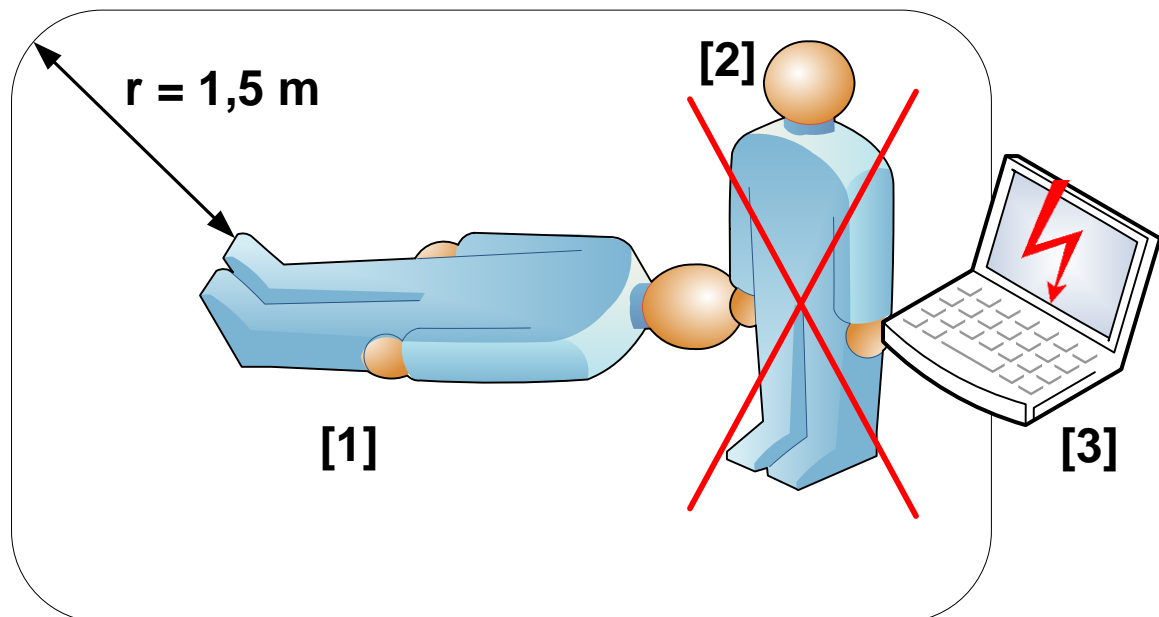

WARNING

When operating the system, the user [2] must ensure that he does not touch the PC [3] and the patient [1] at the same time. The same applies for all other non-medical, electrical components; they may only be used outside the patient's vicinity.

Furthermore, the user must ensure, never to touch the contacts of the connectors of the interface box and the patient at the same time.

In case of non-observance, dangerous leakage currents can occur.

The following components of the FDM system may be used in the vicinity of the patient:

- FDM Sensor
- zebris Measuring Systems for medical purposes (e.g. CMS20, DAB Bluetooth)



WARNING

The computer and other non-medical electrical equipment (e.g. camera equipment, lights) have to be located beyond the reach of the patients (1.5m).

7.2.3 Use of multiple sockets

The following information and warnings are based on the requirements of the Standard DIN EN 60601-1:2006, Section 11 for medical electrical equipment and have to be enforced when the FDM system is used for medical purposes.



WARNING

If multiple sockets are used for connecting the FDM-T system or its components, the following safety regulations are to be observed:

- Always connect the treadmill and FDM sensor directly to mains supply by using a separate wall socket with a tested protective earth conductor and separate fuse.
- Multiple sockets can be used without causing any danger for connecting the PC and other electrical accessories (video camera, illumination) outside the patients' vicinity.
- Multiple sockets must not be placed on the floor to avoid accidentally penetration of liquids or mechanical damages.
- It is forbidden to use extension cables or several multiple sockets connected in series.
- In commercially available multiple sockets, system components set up within and outside the vicinity of the patient must never be plugged in together. (Example: It is forbidden to connect the PC and the power supply unit of the FDM sensors to the same multiple socket.)
- If multiple sockets are used jointly for components of the FDM system, that are allowed to be located within the vicinity of the patient (e.g. treadmill, FDM sensor or other zebris measuring systems) and components that have to be outside the vicinity of the patient (e.g. PC, video camera), the multiple socket and complete interconnection of the system must adhere to all the requirements of DIN EN 60601-1:2006 Section 16. If necessary, an isolating transformer is to be used for an arrangement of this kind, and the ground leakage current in the protective earth conductor of the multiple sockets must not exceed 5 mA. The adherence to the maximum permissible patient leakage currents is to be verified by measuring. If a multiple socket was integrated after setting the system into operation for the first time, no additional device may be connected to it (use multiple sockets with locking covers for this purpose)



WARNING

Coupling the mains connection of components of medical electrical systems and other, not supplied components by using multiple sockets according to EN 60601-1 is a very dangerous practice.

It is possible for excessive touch currents to occur if mains are connected without the user having any respective expert knowledge.

Due to these complications zebris Medical GmbH urgently advises not to use multiple sockets for operation of the system.

7.3 Electromagnetic compatibility Guideline & Manufacturer Declaration

The measuring system FDM fulfils all requirements for EN 60601-1-2

(Medical Electrical Equipment - Part 1-2: General requirements for basic safety and essential performance - Collateral Standard: Electromagnetic compatibility - requirements and tests)

Inspecting authority: SCHWILLE – ELEKTRONIK
Produktions- und Vertriebs GmbH
Benzstrasse 1A
85551 Kirchheim

Detailed information on EMC values and information supplied by the manufacturer can be found in the tables in this Section of the User Manual.

Electrical equipment in the medical field is subject to particular precautionary measures as regards the EMC (Electromagnetic Compatibility) and must be installed and put into operation in accordance with the instructions given below.



WARNING

Even though the motion analysis system FDM fully complies with the requirements of the standard EN 60601-1 it cannot be totally expected that portable and mobile RF communications equipment can affect the system. If ever possible such devices should not be operated within the system environment during measurements



WARNING

The use of accessories, particularly cables for connecting to the PC, that are not supplied by zebris for use with the FDM system, or explicitly recommended for use with the device, can lead to a reduced resistance to EMC interference of the FDM system.



WARNING

The FDM measuring system should not be operated in the vicinity of e.g. X-ray equipment, motors or transformers with a high connected load, as electrical or magnetic interference fields can influence the measurements. The same is applicable for neighboring power lines and equipment without a CE mark. Should operation next to possible sources of interferences be necessary it is mandatory to check and verify the correct function of the system.



NOTE

In the case of over voltages or voltage dips (even short-term) of more than 50% of the mains voltage, functional faults can occur. When such high voltage dips or complete voltage failures occur, the measurement is interrupted and the measuring data is discarded. Finally the measurement has to be re-started, and if need be, also the connected PC.

Guidelines and Manufacturer's Statement - Electromagnetic Emission

The FDM-T force-distribution measuring system is intended for use in the electromagnetic environment described below. The customer or user of the FDM-T force-distribution measuring system should ensure that it is operated in such an environment.

Emitted interference measurements	Compliance	Electromagnetic environment guidelines
RF emissions acc. to CISPR 11	Group 1	The FDM-T force-distribution measuring system uses RF energy exclusively for its internal functions. Therefore its RF emission is very low and it is unlikely that electronic equipment in close proximity will experience interference.
RF emissions acc. to CISPR 11	class B	The FDM-T force-distribution measuring system is intended for use in all facilities including those in residential areas and those directly connected to a public utility network also supplying buildings used for residential purposes.
Emission of harmonic oscillations acc. to IEC 61000-3-2	class B	
Emission of voltage fluctuations / flickers acc. to IEC61000-3-3	in compliance	

Guidelines and Manufacturer's Statement - Electromagnetic Interference Immunity

The FDM-T force-distribution measuring system is intended for use in the electromagnetic environment described below. The customer or user of the FDM-T force-distribution measuring system should ensure that it is operated in such an environment.

Interference immunity tests	IEC 60601 test levels	Compliance level	Electromagnetic environment guidelines
Electrostatic discharge (ESD) acc. to IEC 61000-4-2	± 6 kV contact discharge ± 8 kV atmospheric discharge	± 6 kV contact discharge ± 8 kV atmospheric discharge	Flooring should be of wood or concrete or laid with ceramic tiles. If the flooring is made of synthetic material, the relative humidity must be at least 30%.
Fast transient electrical interferences/bursts acc. to IEC 61000-4-4	± 2 kV for power lines ± 1 kV for input and output lines	± 2 kV for power lines ± 1 kV for input and output lines	The quality of the supply voltage should be the same as the voltage of a typical business or hospital environment.
Surges acc. to IEC 61000-4-5	± 1 kV differential mode voltage ± 2 kV common mode voltage	± 1 kV differential mode voltage ± 2 kV common mode voltage	The quality of the supply voltage should be the same as the voltage of a typical business or hospital environment.
Blackouts, brownouts and fluctuations of the power supply acc. to IEC 61000-4-11	< 5% U_T (> 95% crash of the U_T) for ½ period 40% U_T (60% crash of the U_T) for 5 periods 70% U_T (30% crash of the U_T) for 25 periods < 5% U_T (> 95% crash of the U_T) for 5 s	< 5% U_T (> 95% crash of the U_T) for ½ period 40% U_T (60% crash of the U_T) for 5 periods 70% U_T (30% crash of the U_T) for 25 periods < 5% U_T (> 95% crash of the U_T) for 5 s	The quality of the supply voltage should be the same as the voltage of a typical business or hospital environment. If the user of the FDM-T force-distribution measuring system requires the continuation of functionality also after power interruptions/disruptions, it is recommended to provide the FDM-T force-distribution measuring system with power from an uninterruptible power supply.
Magnetic field with supply frequency (50/60 Hz) acc. to IEC 61000-4-8	3 A/m	Not tested as no influence is possible on the device within the specified test level. (see Note B)	Magnetic fields of the mains power frequency should comply with the typical values of a business and hospital environment.

NOTE U_T is the AC main voltage prior to applying the test levels.

Guidelines and Manufacturer's Statement - Electromagnetic Interference Immunity

The FDM-T force-distribution measuring system is intended for use in the electromagnetic environment described below. The customer or user of the FDM-T force-distribution measuring system should ensure that it is operated in such an environment.

Interference immunity tests	IEC 60601 test levels	Compliance level	Electromagnetic environment guidelines
			Portable and mobile wireless sets should not be used in closer proximity to the FDM-T force-distribution measuring system, including the cables, than the recommended safety distance, that is calculated on the basis of the formula suitable for the transmitting frequency. Recommended safety distance:
Conducted RF interference quantities acc. to IEC 61000-4-6	3 V _{eff} 150 kHz to 80 MHz	3 V _{eff}	$d = 1.2\sqrt{P}$
Radiated RF interference quantities acc. to IEC 61000-4-3	3 V/m 80 MHz to 2.5 GHz	3 V/m	$d = 1.2\sqrt{P}$ 80 MHz to 800 MHz
			$d = 2.3\sqrt{P}$ 800 MHz to 2.5 GHz
			With P as the rated output of the transmitter in watts (W) according to the information provided by the manufacturer of the transmitter and d as the recommended safety distance in meters (m). The field strength from fixed RF transmitters as determined by an electromagnetic site survey ^a is less than the compliance level ^b in all the frequencies. Interference is possible in the proximity of devices featuring the following pictograph
NOTE 1	The higher value applies in the case of 80 MHz and 800 MHz		
NOTE 2	These guidelines may not be applicable in all situations. The spread of electromagnetic waves is influenced by absorption and the reflections of buildings, objects, and people		
a	The field strength of stationary transmitters, such as the base stations of mobile phones and land mobile services, ham radio stations, AM and FM radio and TV broadcasters is theoretically not 100% predictable. A site study is recommended to determine the electromagnetic environment as a result of stationary RF transmitters. If the measured field strength at the site of the FDM-T force distribution measuring system exceeds the compliance levels listed above, the FDM-T force distribution measuring system must be monitored to document its proper functionality at every place of application. Additional measures might become necessary, e.g. modifying the orientation or moving the location of the FDM-T force-distribution measuring system, if unusual performance characteristics are observed.		
b	The field strength is less than 3 V/m for the frequency range of 150 kHz to 80 MHz		

Recommended Safety Distances between Portable and Mobile RF Telecommunications Devices and the FDM-T/FDM-T force-distribution measuring system

The FDM-T force-distribution measuring system is intended for use in an electromagnetic environment where RF interference quantities are controlled. The customer or user of the FDM-T force-distribution measuring system can contribute towards preventing electromagnetic emissions by complying with the minimum distance between portable and mobile RF telecommunications devices (transmitters) and the FDM-T force-distribution measuring system, as recommended below in accordance with the maximum output power of the communication device.

Rated output of the transmitter (W)	Safety distance based on the transmitting frequency (m)		
	150 kHz to 80 MHz $d = 1.2\sqrt{P}$	80 MHz to 800 MHz $d = 1.2\sqrt{P}$	800 MHz to 2.5 GHz $d = 2.3\sqrt{P}$
0.01	0.12	0.12	0.23
0.1	0.38	0.38	0.73
1	1.2	1.2	2.3
10	3.8	3.8	7.3
100	12	12	23

The safety distance for transmitters with a rated output not listed in the table above, can be calculated by applying the formula corresponding to the respective column, whereby P is the rated output of the transmitter in watts (W) as specified by the transmitter manufacturer.

NOTE 1 For calculating the recommended safety distance of transmitters in the frequency range of 80 MHz to 2.5 GHz, an additional factor of 10/3 was used to reduce the probability of a mobile/portable telecommunications device taken unintentionally into the patient's area, causing interference.

NOTE 2 These guidelines may not be applicable in all situations. The spread of electromagnetic waves is influenced by absorption and the reflections of buildings, objects, and people.

7.4 Declaration of conformity medical platforms

EG - KONFORMITÄTSERKLÄRUNG EC - DECLARATION OF CONFORMITY



Hersteller / manufacturer

zebris Medical GmbH
Am Galgenbühl 14
88316 Isny
Deutschland / Germany

Wir erklären in alleiniger Verantwortung, dass / We declare under our sole responsibility that
das Medizinprodukt / the medical device

Kraftverteilungsmesssystem FDM
Force Distribution Measurement System FDM

Modell/Typ / Model/Type

FDM-SX	FDM-S	
FDM-1.5	FDM-2	FDM-3
FDM-1.7	FDM-2.4	
FDM-J1.0	FDM-J1.8SQ	

UMDNS Nummer / UMDNS Code

17-242

Klassifizierung / classification

Im

nach Regel / according to rule

12

den Anforderungen der unten genannten Richtlinien / Normen soweit anwendbar entspricht.
meets all requirements of the directives and standards listed below which apply to it.

Konformitätsbewertungsverfahren nach /
conformity assessment procedure acc. to

Richtlinie 93/42/EWG Anhang V
geändert durch Richtlinie 2007/47/EWG
Directive 93/42/EEC Annex V
amended by Directive 2007/47/EEC

Angewandte harmonisierte Normen /
Applied harmonized standards

DIN EN 1041	DIN EN 60601-1
DIN EN 10993-1	DIN EN 60601-1-2
DIN EN 13485	DIN EN 60601-1-6
DIN EN 14971	DIN EN 62304
DIN EN 15223-1	DIN EN 62366

Diese Konformitätserklärung gilt für alle oben gelisteten Medizinprodukte welche am oder nach dem Ausgabedatum von zebris hergestellt worden sind. Die Gültigkeit dieser Konformitätserklärung endet mit der Veröffentlichung einer Konformitätserklärung neueren Datums, falls dies durch technische Änderungen am Produkt oder durch Änderungen von Richtlinien oder Normen erfolgen muss, spätestens jedoch mit Ablauf des CE-Zertifikats nach Richtlinie 93/42/EWG mit Nr. CE 573437.

This declaration of conformity is valid for all medical devices listed above which have been manufactured by zebris at or after the date of issue. The validity of this declaration expires with the release of a new declaration due to technical or legal amendments – however latest at the expiry date of the CE-certificate according to directive 93/42/EEC with certificate number CE 573437.

D-88316 Isny, 20. November 2015

Wolfgang Brunner
Geschäftsführer / Managing Director
zebris Medical GmbH

Benannte Stelle / Notified Body
BSI Group Deutschland GmbH
D-60314 Frankfurt am Main

CE 0535