

Specifications and Operating Instructions (Sport)



FDM-T
SYSTEM  zebris

Content

1	INTRODUCTION	4
1.1	MANUFACTURER INFORMATION	4
1.2	STRUCTURE OF THE FDM-T SYSTEM USER MANUAL	5
1.3	CONVENTIONS AND SYMBOLS USED	6
2	SAFETY	7
2.1	ENVIRONMENTAL CONDITIONS	7
2.2	STORAGE AND TRANSPORT	7
2.2.1	USER OBLIGATIONS	8
2.2.2	GENERAL SAFETY INSTRUCTIONS	9
2.2.3	SAFETY INSTRUCTIONS FOR THE TREADMILL	10
2.2.4	PROHIBITED USE	11
3	PRODUCT DESCRIPTION	12
3.1	SYSTEM COMPONENTS	12
3.2	SPECIFICATIONS FDM-T SENSOR	12
3.3	TECHNICAL SPECIFICATIONS FDM-T MEASURING SYSTEMS	12
3.4	MEASURING PRINCIPLE FDM-T SYSTEMS	19
3.5	CONTROLS AND CONNECTORS	20
3.6	LED INDICATOR LIGHTS OF THE INTERFACE BOX	20
3.7	ZEBRIS SYNC	20
3.7.1	SYNCHRONIZATION INPUT (SYNC-IN)	21
3.7.2	SYNCHRONIZATION OUTPUT (SYNC-OUT)	22
3.8	SPARE PARTS FDM-T SYSTEM	23
3.9	ACCESSORIES FDM-T MEASURING SYSTEM	24
4	VIDEO-MODULE	26
4.1	CONNECTION TO THE FDM-T SYSTEM	26
4.1.1	CONNECTION TO THE ZEBRIS SYNC CAM	26
4.1.2	CONNECTION SCHEME SYNCLIGHTCAM	27
4.2	SYNCCAM	28
4.3	SYNCLIGHTCAM – VARIANT 30 Hz	29
4.4	SYNCLIGHTCAM HS – VARIANT 120 Hz	31
5	GAIT TRAINING MODULE	34
5.1	GAIT TRAINING TYPE M (H/P/COSMOS MERCURY)	35
5.2	GAIT TRAINING TYPE Q AND (H/P/COSMOS QUASAR)	36
6	SETUP AND OPERATION OF THE FDM-T SYSTEM	37
6.1	POSITIONING OF THE MEASURING SYSTEM	37
6.2	INSTALLATION OF THE DETACHABLE CABLE GUARD	38
6.3	CONNECTION OF THE MEASURING SYSTEM TO MAINS SUPPLY	39
6.3.1	POWER SUPPLY OF THE FDM-T SENSORS	39
6.3.2	CONNECTION OF THE SYSTEM	40
6.4	COMPUTER REQUIREMENTS	40
6.5	INSTALLING THE ZEBRIS FDM SOFTWARE	40
6.6	HOW TO SWITCH THE FDM-T SENSOR ON/OFF	41
6.7	SETTING THE SYSTEM OUT OF OPERATION	41
6.8	RECOMMENDATIONS FOR RECORDING	41
6.8.1	TREADMILL ANALYSIS	41
6.8.2	DATA RECORDING	41
6.8.3	WALKING SPEED	41
6.8.4	POSTURE	41
6.8.5	WEALS	41
7	MAINTENANCE AND SAFETY INSPECTIONS	42
7.1	GENERAL MAINTENANCE PROCEDURES	42
7.2	MANDATORY PERIODIC INSPECTIONS AND STK	43
7.4	MAINTENANCE OF THE FDM-T SENSOR	44
7.4.1	CONTROL PROCEDURES	44
7.4.2	CALIBRATION PROCEDURES	44

7.5	TROUBLESHOOTING.....	45
7.6	CLEANING AND DISINFECTION.....	46
7.6.1	CLEANING PROCEDURE	46
7.6.2	DISINFECTION PROCEDURE.....	46
7.7	DISPOSAL	47
7.7.1	PACKAGING.....	47
7.7.2	WEEE-DIRECTIVE	47
7.7.3	ACCUMULATORS AND BATTERIES.....	47

1 Introduction

© 2019 zebris Medical GmbH

All rights reserved. Reproduction in whole or in part only with the express permission of zebris Medical GmbH.

Illustrations of this manual may differ.

1.1 Manufacturer Information



Manufacturer

zebris Medical GmbH	Phone	+49 (0)7562 9726 - 0
Am Galgenbühl 14	Fax	+49 (0)7562 9726 - 50
88316 Isny im Allgäu	E-Mail	info@zebris.de
Germany	Web	www.zebris.de

Sales / Support

zebris Medical GmbH	Phone	+49 (0)7562 9726 - 300
Am Galgenbühl 14	Fax	+49 (0)7562 9726 - 50
88316 Isny im Allgäu	E-Mail	support@zebris.de
Germany	Web	www.zebris.de



HINWEIS

Please always provide the serial number of the product for inquiries!

1.2 Structure of the FDM-T System user manual

The FDM-T measuring system consists of a treadmill, the pressure distribution measuring sensors and the corresponding application software, including the PC. The sensors and treadmill can also be used completely independently of each other and feature a separate power supply and CE mark.

The user manual for the FDM-T measuring system therefore consists of several sections:

1. FDM-T specifications and hardware user manual
2. zebris FDM user manual for the application software
3. Specifications and user manual supplied by the treadmill manufacturer
4. User manual and specifications of accessories like projector or PC



NOTE

Please also be sure to adhere to the user manuals supplied by manufacturers of the treadmill and the accessories when setting the system into operation, while using it, maintaining it and transporting it.

The section FDM-T specifications and hardware user manual mainly contains information regarding the specifications and operation of the FDM-T pressure distribution measuring sensors and their safe operation in combination with the treadmill, as a measuring system. Instructions regarding the treadmill are restricted to the main safety and servicing measures.



WARNING

The exact adherence to the instructions in all sections of the operating instructions for the measuring system is a precondition for its intended use.

1.3 Conventions and Symbols Used



“**WARNING**” symbols indicate a potential hazard to the health and safety of the users and/or patients. The warnings describe the risks involved and those that can be avoided.



Note symbols indicate a potential hazard that can result in damage of the device. The notes explain the type of hazard and how it can be prevented.



CE mark according to EC Directives 2014/30/EEC and 2014/35/EEC (Low Voltage Directive and EMC Directive).



Manufacturer



Manufacturing Date



Direct Current



USB-Interface



Do not dispose of with household waste



This symbol indicates a potential hazard that can cause a loss of eyesight. This warning indicates the type of hazard and how it can be avoided.



Item Number



Serial Number

2 Safety

2.1 Environmental conditions

FDM-T measuring systems are suitable for application in dry interiors with level ground such as those in hospitals, doctors' surgeries and laboratories.

Temperature	10°C to 40°C
Relative humidity	30% to 70%, non condensing
Air pressure	700 to 1100 hPa



FDM-T systems must NOT be operated in wet zones, wet rooms (swimming pools, saunas) or climatic chambers.

Direct contact with liquids must always be avoided, as the measuring system is not protected against the entry of liquids. Liquids penetrating the device can cause fire, electrical shock or other severe accidents.

The FDM-T system is NOT specified for the operation in vacuum, hyperbaric or altitude chambers.

The measuring systems are not intended for operation in potentially explosive atmospheres of medically used rooms or oxygen-enriched atmospheres.

The devices must not be operated in proximity to e.g. engines or transformers with a high connected load as well as mains current lines, as electrical or magnetic interference fields can falsify correct measurements resp. turn them impossible. Therefore, the devices have to be protected against humidity. The ventilation slots of the treadmills must be free at all times, so that air can circulate freely.

2.2 Storage and Transport

Storage and transport of the measuring system are only to be effected in the original packaging provided by zebris.

Temperature	-20°C to +70°C
Relative humidity	max. 95%, non condensing
Protect from moisture	



All FDM-T systems can be stored without power supply for a maximum of 6 to 9 months. After this period, the battery may be totally discharged due to lacking power supply. If the storage of the device exceeds this period, a re-programming of the treadmill control may be necessary.

2.2.1 User Obligations



- Users are obliged to:
 - ✓ observe all safety guidelines of the user manual.
 - ✓ carry out any inspection and maintenance works on a regular basis as stipulated in the user manual.
 - ✓ only use work equipment that is free of defects.
 - ✓ check the functional safety and the proper condition of the device before operating.
 - ✓ make all user manuals that are included in delivery and part of the measuring system accessible to all users at all times and keep the manuals in close proximity of the measuring system.
 - ✓ protect him-/herself, the patient or third parties against dangers.
 - ✓ avoid a contamination through the product.
- When using the system, national legal regulations must be observed, in particular:
 - ✓ the valid industrial safety regulations.
 - ✓ the valid accident prevention measures.
- For the safety, reliability and performance of the components delivered by zebris, responsibility is assumed, if:
 - ✓ assembly, extensions, re-settings, changes or repairs were carried out through zebris or third parties authorised by zebris, trained technicians or employees of authorised dealers. Storage and transport are only to be effected in the original packaging delivered by the manufacturer.
 - ✓ the device is operated in accordance with the user manual.
 - ✓ the components of information technology provided by the operator correspond to the technical requirements of hard and software included in this user manual and also were installed and set up according to the relevant descriptions in this user manual.
 - ✓ the set-up room corresponds to the given environmental conditions of the measuring system and the valid installation regulations.
 - ✓ the FDM-T system including accessories is connected to the mains socket with a protective grounding conductor and is operated with the correct mains voltage.
 - ✓ exclusively the software provided by zebris as well as the components and accessory parts listed in this user manual are used together with the system.

2.2.2 General safety instructions



- The application and operation of the system and also the evaluation of the measuring data and their interpretation may only be carried out by trained qualified personnel. The manufacturer assumes no liability for any injury to persons, damage to property, or loss of data due to improper use of the software, the device or its component parts.
- The clients data and measuring data may only be copied, moved, or deleted using the database function provided by the zebris application programs. In the case of data being changed intentionally without using the database functions, the user alone bears the full risks involved.
- Should there be any detectable damage to the device or component parts, they should be returned to the manufacturer for a safety check. It is not permissible to continue using the device or its component parts, as severe damage and serious injuries – even lethal injuries - may result. The manufacturer or authorized sales partner must always be contacted in all cases of fault or doubt.
- If any fluids should penetrate the device, it is mandatory for the device to undergo a technical, safety test. Damaged plug connections and leads are to be replaced by an authorized service technician. The device must be put out of operation immediately, marked as "Not working" and prevented from being used by removing the mains cable. Please refer to an authorized technician immediately.
- Be sure that all the mains and connection cables are laid safely and that they are protected against stepping on, so that nobody can trip over them. Check all the cables and the connection plug regularly for any damage. Damaged power supplies and cables have to be replaced before further operation.
- Never insert any objects in the components of the measuring system.
- A highly precise speedometer is integrated within the FDM-T System. This device contains a laser Class 2 ($\lambda=650\text{nm}$, $P>1\text{mW}$). It is strictly forbidden to remove all covers of the treadmill which are marked with the symbol shown left as long as the measuring platform is connected to mains supply (as long as the external power supply unit of the platform is plugged to mains supply). Caution: If other procedures than those described within this user manual are conducted, dangerous laser radiation can be released. Direct eye contact with the laser beam may lead to serious injuries of the eye.



2.2.3 Safety instructions for the Treadmill



- The treadmill belonging to the FDM-T measuring system is a very powerful device. For safe operation of the FDM-T system it is mandatory to adhere exactly to the safety regulations described in the following.
- The measuring procedure on the treadmill must never be commenced without a thorough instruction of the patient by trained personnel. No measurements may be taken without a supervisor.
- Do not place the treadmill on an unstable ground.
- Do not set up the system near a source of heating or in direct sunlight in front of a window as a strong rise in temperature can lead to inaccurate measuring results.
- Directly behind the treadmill it is mandatory for a safety zone of 2 m in length and 1 m in width to be kept free, and ought to be padded (with a soft mat). No items may be left in this zone during operation (such as video camera, lighting equipment etc.).
- Dangerous drawing-in gaps are located at the rear end of the running belt and along its sides and (if existing) on the elevating mechanism. Do not wear any loose clothing that could get caught up in the rollers. Make absolutely sure that if a person trips over, their long hair, loose clothing, jewellery, etc., do not come into contact with the rear part of the treadmill belt (e.g. wear a hair net). Due to danger of stumbling, do not place any clothing or jewellery on or within close proximity of the treadmill.
- Never use the treadmill without the safety clip being fastened to your clothing and always be sure that the folding mechanism (if existing) is properly locked during operation. (Please also be sure to read the safety instructions in the user manual supplied by the treadmill manufacturer.)
- During operation, the Emergency STOP facilities must always be within easy reach for the user and the operating personnel.
- The patient should walk slowly to begin with. Then gradually speed can be increased after a few minutes, depending on the patient's physical condition. Improper or excessive strain through tests resp. measurements can have harmful effects on health.
- Never jump onto the running belt and never jump off it whilst it is running. Never stop walking while the treadmill is running, never turn round or step sideward or backwards. Should movement patterns of this kind be necessary for your measurements, please make sure to use a type of treadmill with a safety arch, protection against falling and a "fall stop" chest belt.
- Pull out the power plug before transporting the treadmill.

2.2.4 Prohibited Use



- Improper and/or prohibited use of the measuring system is impermissible and zebris warn explicitly against all prohibitions included in this section.
- Do not try to service the treadmill in any manner other than that described in this user manual. By the removal of the protective covers it is possible that you could expose yourself to lethal high voltages or other hazards.
- We also point out that if any changes are made to this certified device or its accessories without the prior written consent of zebris, your legal right to operate the device will be void. If changes are made to the device without obtaining approval, the operator is obligated to carry out suitable investigations and tests in order to guarantee safe use.
- It is prohibited to embed the treadmill in the floor in order to reduce (track) access height. This way of installation might create a highly dangerous capture area at the rear guide pulley of the treadmill. The zebris Medical GmbH expressly will undertake no liability for injuries to any person when the treadmill is operated under such condition!
- All applications using wheels are prohibited (cycling, wheelchair, inline skating or roll ski) as well as running shoes with spikes or studs. Besides their extremely high risk of injury, these can cause irreparable damage to the sensors.
- There should never be more than one person on the treadmill at a time once it is in operation.
- Children and animals are not allowed to use the treadmill without supervision and must maintain a safety distance of at least 5 m.
- Any manner of over-exerting the test persons is strictly prohibited. In cases of nausea and dizziness, the measuring is to be discontinued immediately and a doctor consulted.
- Any form of operation involving an increased hazard is strictly prohibited, e.g. sprinting, or also using test persons having an increased risk.
- The use of the measuring system under the influence of alcohol, drugs or narcotics is strictly prohibited.
- zebris measuring systems may not be operated in any other environmental conditions than those listed in the section "Specifications", (e.g. in wet zones, moisture-prone areas, or in climatic, vacuum, hyperbaric or decompression chambers, etc.). Direct contact with liquids must always be avoided, as the measuring system is not protected against entering liquids. Liquids entering the device can cause fire, electric shock or other severe accidents.

3 Product description

3.1 System Components

In its basic configuration the measuring system consists of the following components:

- Treadmill with integrated sensor equipment for measuring the pressure distribution
- Safety clip for the emergency shutdown
- Mains cable for connecting the treadmill
- External power supply unit for the FDM-T pressure plate
- USB cable (Type A-B, 3 m long)
- zebris application software zebris FDM
- Windows-compatible computer or notebook
- Silicone oil for lubricating the belt
- Cable guard with screws
- User manual for FDM-T system, treadmill, zebris FDM software

3.2 Specifications FDM-T Sensor

The sensors of the different FDM-T systems only vary in size of the measuring area, the number of single sensors included in the sensor module and the supported sampling frequency. All other technical specifications are identical.

Interfaces	USB synchronization input/output video synchronization infrared synchronization (optional)
Connectors	interface box on the treadmill housing frame
Measuring principle	capacitive pressure measurement
Operating voltage	16-18V DC
Power consumption	maximum 60 W (depending on the type)
Power supply via external power supply unit	100 – 240 VAC / 50/60 Hz
Accuracy of the calibrated measuring range	(1 – 120 N/cm ²) ±5 % of maximum range
Mechanical cross talk	-25 dB
Pressure threshold	1 N/cm ²

3.3 Technical specifications FDM-T measuring systems

With the most system types, the FDM-T sensor is available in the resolutions 1.4 sensors/ cm² (3i) and 0.6 sensors/ cm² (2i).

Type

FDM-TLK3



Treadmill

Kettler Track 3

Speed	1 - 16 km/h in 0.1 km/h intervals
Running surface	132 x 46 cm
Engine Power	1.5 kW
Power Supply	230 V AC, 50 Hz
Weight	85 kg
Dimensions (L x W x H)	184 x 84 x 137cm / geklappt 94 x 84 x 171 cm
Track access height	16 cm
Elevation	none
Max. user weight	120 kg
Colour	silver, black

Version

FDM-TLK3-3i

REF	01543135
-----	----------

Platform

REF	01243062
Sensor Area / cm	94.8 x 40.6
Number of Sensors	112 x 48 / 5376
Resolution	1.4 sensors/ cm ²
Sampling Frequency	100 Hz
Infrared Interface	optional IR-Box

Type**FDM-TS30****Treadmill****Cardiostrong TR30i**

Speed	1 - 18 km/h, recommended 1 - 12 km/h
Running surface	125 x 50 cm
Engine Power	1.8 kW
Power Supply	230 V AC, 50 Hz
Weight	92 kg
Dimensions (L x W x H)	184 x 84 x 137cm / folded 94 x 84 x 171 cm
Track access height	16 cm
Elevation	0 - 15 %
Max. user weight	136 kg
Colour	black

Version**FDM-TS30-2i****FDM-TS30-3i**

REF	01543236	01543136
-----	-----------------	-----------------

Platform

REF	01243278	01243078
Sensor Area / cm	91.4 x 39.4	94.8 x 40.6
Number of Sensors	2232	112 x 48 / 5376
Resolution	0.6 Sensors /cm ²	1.4 Sensors /cm ²
Sampling Frequency	100 Hz	100 Hz
Infrared Interface	optional IR-Box	optional IR-Box

Type**FDM-TS70****Treadmill****Cardiostrong TR70i**

Speed	0.8 to 20 km/h in 0.1 km/h intervals
Running surface	145 x 50 cm
Engine Power	2.2 kW
Power Supply	230 V AC, 50 Hz
Weight	135 kg
Dimensions (L x W x H)	189 x 84 x 137 cm
Track access height	18 cm
Elevation	0 % – 15% in 1% intervals
Max. user weight	159 kg
Colour	light-grey / black

Version**FDM-TK9L-3i****FDM-TK9-3i****FDM-TK9-2i**

REF	01543114	01543116	01543221
-----	-----------------	-----------------	-----------------

Platform

REF	01243073	01243072	01243272
Sensor Area / cm	94.8 x 40.6	108.4 x 47.4	111.8 x 49.5
Number of Sensors	112 x 48 / 5376	128 x 56 / 7168	88 x 39 / 3432
Resolution	1.4 sensors/ cm ²	1.4 sensors/ cm ²	0.6 sensors/ cm ²
Sampling Frequency	100 Hz	120 / 240 Hz	120 / 240 Hz
Infrared Interface	optional IR-Box	optional IR-Box	optional IR-Box

Type**FDM-THPL****Treadmill****h/p/cosmos pluto**

Speed	0.5 - 18 km/h in 0.1 km/h intervals
Running surface	150 x 50 cm
Engine Power	2.2 kW
Power Supply	230 V AC, 50 Hz
Weight	211 kg
Dimensions (L x W x H)	210 x 85 x 130 cm
Track access height	23 cm
Elevation	0 – 20 %
Max. user weight	200 kg
Colour	pure white RAL 9010

Version**FDM-THPL-S-3i****FDM-THPL-S-2i**

REF	01543155	01543230
-----	-----------------	-----------------

Platform

REF	01243060	01243251
Sensor Area / cm	101.6 x 47.4	101.6 x 49.5
Number of Sensors	120 x 56 / 6720	80 x 39 / 3120
Resolution	1.4 sensors/ cm ²	0.6 sensors/ cm ²
Sampling Frequency	120 / 240 Hz	120 / 240 Hz
Infrared Interface	optional IR-Box	optional IR-Box

Type**FDM-THM****Treadmill****h/p/cosmos mercury**

Speed	0 to 22 km/h in 0.1 km/h intervals
Running surface	150 x 50 cm
Engine Power	3.3 kW
Power Supply	230 V AC, 50 Hz
Weight	220 kg
Dimensions (L x W x H)	210 x 80 x 137 cm
Track access height	18 cm
Elevation	0 – 25 % (-25 % to + 25 % with option of running direction reversal)
Max. user weight	200 kg
Colour	pure white RAL 9010

Version**FDM-THM-S-3i****FDM-THM-S-2i**

REF-No.	01543115	01543215
---------	-----------------	-----------------

Platform

REF-No.	01243050	01243250
Sensor Area / cm	108.4 x 47.4	111.8 x 49.5
Number of Sensors	128 x 56 / 7168	88 x 39 / 3432
Resolution	1.4 sensors/ cm ²	0.6 sensors/ cm ²
Sampling Frequency	120 / 240 Hz	120 Hz
Infrared Interface	optional IR-Box	optional IR-Box

Type**FDM-THQ****Treadmill****h/p/cosmos quasar**

Speed	0 to 25 km/h in 0.1 km/h intervals
Running surface	170 x 65 cm
Engine Power	3.3 kW
Power Supply	230 V AC, 50 Hz
Weight	430 kg
Dimensions (L x W x H)	210 x 105 x 137 cm
Track access height	23 cm
Elevation	0 – 28 % (-28 % to + 28 % with option of running direction reversal)
Max. user weight	200 kg
Colour	pure white RAL 9010

Version**FDM-THQ-S-3i****FDM-THQ-S-2i**

REF-No.	01543140	01543240
---------	-----------------	-----------------

Platform

REF-No.	01243052	01243252
Sensor Area / cm	135.5 x 54.1	132.1 x 55.9
Number of Sensors	64 x 160 / 10240	44 x 104 / 4576
Resolution	1.4 sensors/ cm ²	0.6 sensors/ cm ²
Sampling Frequency	120 / 300 Hz	120 Hz
Infrared Interface	optional IR-Box	optional IR-Box

3.4 Measuring Principle FDM-T Systems

The system contains a measuring matrix consisting of capacitive pressure sensors that are arranged in columns and lines running closely next to each other. For determining the pressure distribution over the measuring matrix the capacity proportional to the pressure exerted is determined for each individual sensor. To do this, the drive logic generates a number of sinus burst signals equivalent to the number of columns via the column decoder, and transmits them to the respective measuring column. The analogue signal coupled into the shift register over the lines is proportional to the pressure-dependent capacity and is passed on for further processing to the control and signal-processing electronics and transmitted to the PC from there and shown on the display.

Schematic circuit diagram of the measuring system

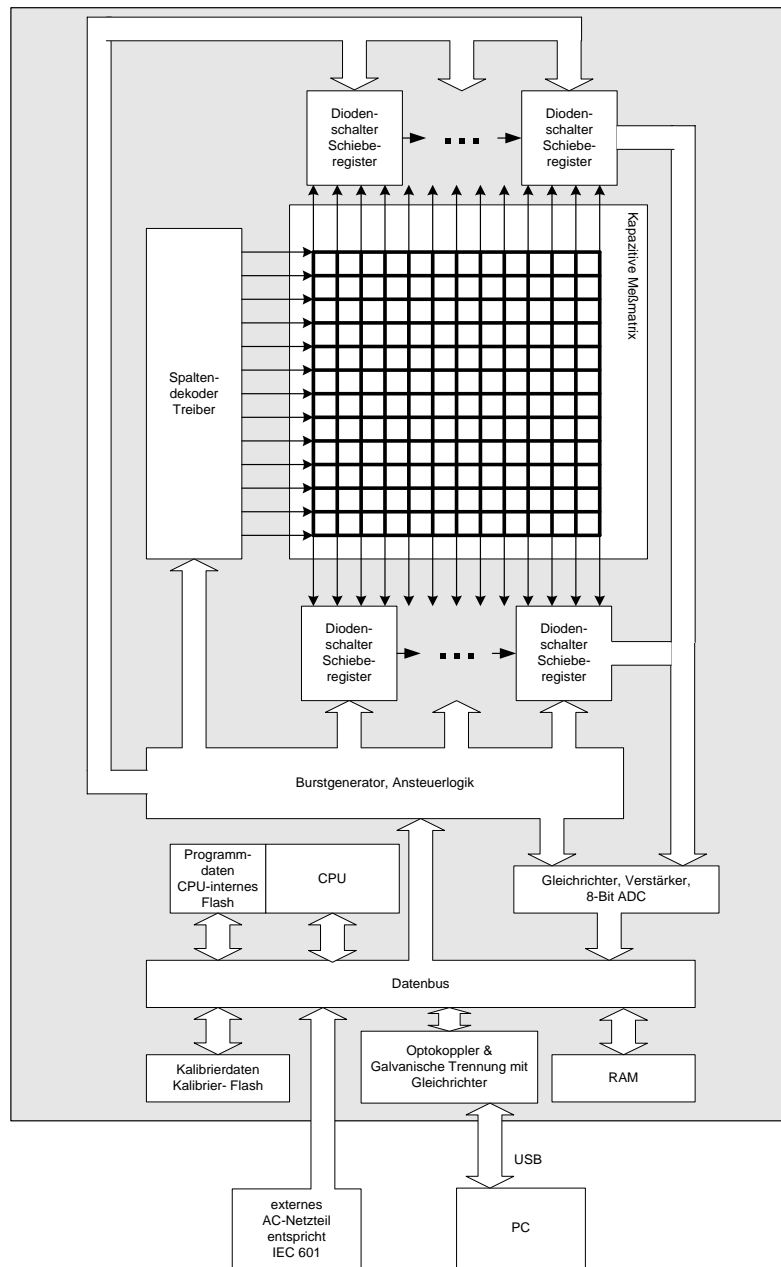

3.5 Controls and Connectors

All the cable connections are carried out via the interface box which is located on the underneath of the treadmill frame on the back.

3.6 LED indicator lights of the interface box

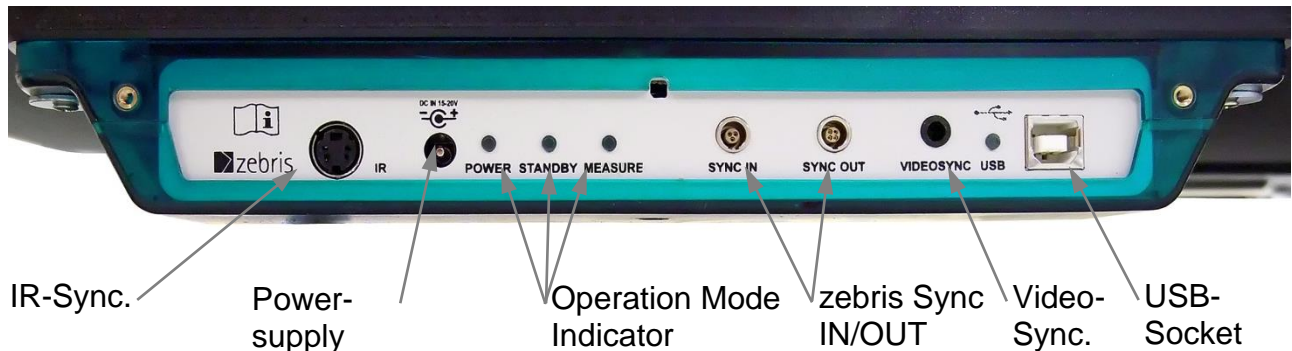

POWER lights up as soon as the power supply unit is plugged to the interface box and connected to mains.

STANDBY lights up if the power supply unit is connected to mains, the USB socket is connected to the PC and the hardware driver of the platform is installed properly.

MEASURE lights up during the measurement.

USB lights up when the USB socket is connected to the PC and the hardware driver of the platform is installed properly.

3.7 zebris SYNC

The **zebris SYNC** is the standard solution for synchronization of the FDM-T system with third party measuring devices. The **SYNC-IN** and **SYNC-OUT** sockets provide input and output for support of „sample by sample“ In- and Out synchronization. Both sockets provide galvanic protection between third party systems and FDM-T sensor.

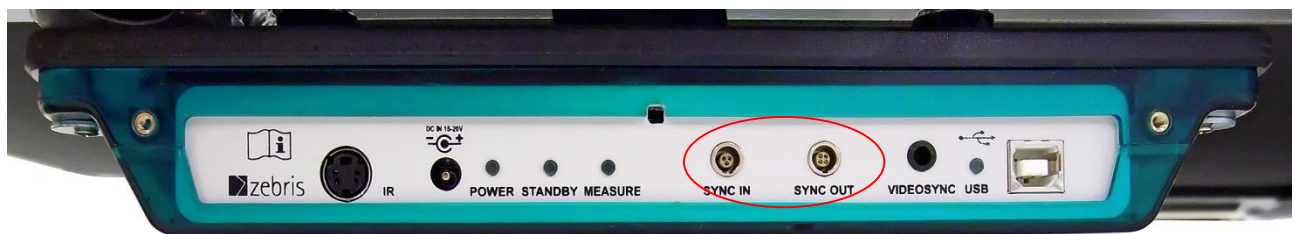

WARNING

The correct synchronisation of all measurement data has to be verified in case devices are connected to zebris SYNC which have not been manufactured by zebris Medical GmbH.

zebris does not accept any liability for correct function and reliability of the system if the clock signal of external devices does not comply with the signal specifications provided with in this user manual.

3.7.1 Synchronization Input (SYNC-IN)

If a third party device is connected to the synchronization input SYNC-IN then depending on the setting of the configuration window from the application software the measurement will start/stop or "sample by sample" synchronized by a signal from the third party device.

Input is protected against faulty polarisation and pin 1 is set to +5V ("1") by an internal pull-up-resistor (2.7 kΩ). If this input is set to 0 V ("0") i.e. by a switch or break contact than the SYNC-IN is triggered.

Electrical Specifications

Input Resistance (Pull-Up 5V)	2.7 kΩ
V _{IH} (High-Level Input Voltage)	≥ 2.0 V
V _{IL} (Low-Level Input Voltage)	≤ 0.8 V
Required min. pulse time for triggering	1ms

Integrated LEMO socket in the interspace box

Series "00", three pole, coding 30°

LEMO-Part-No.: EPA.00.303.NLN



View
Socket, Front Side

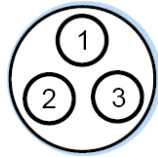

Socket Coding: 30°



Suitable Plug for SYNC-IN:

LEMO-Part-No.: FGA.00 303.CLADxxxx

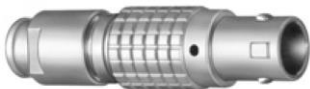

View
Plug, Solder Side



Plug Coding: 30°



Pin Assignment

Pin 1	Clk_IN
Pin 2	Activ_IN
Pin 3	GND

3.7.2 Synchronization Output (SYNC-OUT)

If a third party device is connected to the synchronization output SYNC-OUT then depending on the setting of the configuration window of the application software, a FDM-T system controlled, will trigger a synchronized measurement of the third party device either via start/ stop or “sample by sample” mode.

Electrical Specifications

Output Resistance 100 Ω
VOH (High-Level Output Voltage) ≥ 2.0 V
VOL (Low-Level Output Voltage) ≤ 0.8 V

Integrated LEMO socket in the interspace box

Series "00", four pole, Coding 0°

LEMO-Part-No.: EPG.00.304.NLN



View
Socket, Front Side

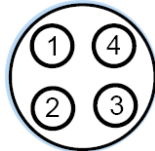

Socket Coding: 0°



Suitable Plug for SYNC-OUT

LEMO-Part-No.: FGG.00 304.CLADxxxx

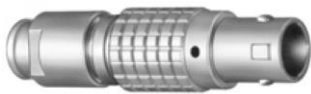

View
Plug, Solder Side









Plug Coding: 0°

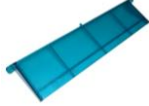

Pin-Assignment

Pin 1 +5V
Pin 2 GND
Pin 3 Activ_OUT
Pin 4 Clk_OUT

3.8 Spare Parts FDM-T System

REF	Description	Illustrations
01832035	FDM-T Interface Box 2 incl. fixation screws	
11511021	Cable protection cover for mounting on the interface box incl. fixation screws	
33102024	PS Mascot 2420 Power supply unit 60W/16VDC for FDM-T sensors equiv. to EN 60601-1 & UL	
21030071	USB cable A-B, 3 m long Data connection between interface box and PC	
07200010	zebris FDM Software for operating system Windows 7 / 64 Bit	
79010094	Hardware User Manual The print edition is subject to a charge. Availability from 5 working days after receipt of order.	
79010185	Software User Manual The print edition is subject to a charge. Availability from 5 working days after receipt of order.	

3.9 Accessories FDM-T Measuring System

REF	Description	Illustrations
01540191	<p>SYNCCam</p> <p>Camera with USB-Cable, synchronization cable, inclusive software extension</p>	
01540194	<p>SYNCLightCam – Variant 30 Hz</p> <p>Combined solution with Camera and illumination, 5 m USB2.0-Cable, synchronization cable, inclusive software extension</p>	
01540194	<p>SYNCLightCam HS – Variant 120 Hz</p> <p>Combined solution with Camera and illumination, 1 m USB3.0-Cable, 20 m USB3.0 fibre optical cable A-male/ A-female, synchronization cable, inclusive software extension</p>	
21030321	<p>SYNCCam/SYNCLightCam 30 Hz USB-Cable A-B</p> <p>USB2.0-Cable for HD-video signal with high quality plugs, EMC-shielding and ferrites length 5 m</p>	
21030106	<p>SYNCLightCam HS USB3.0-Cable A-B</p> <p>USB3.0-Cable for data connection between SYNCLightCam HS and fibre optical cable length 1 m</p>	
21030110	<p>USB3.0 fibre optical cable A-male/ A-female</p> <p>Extension cable between USB3.0 cable A-B 1 m and PC length 20 m</p>	
21030316	<p>Video Sync-Control Cable 5</p> <p>Length 5 m, both sides phone jack 3.5 mm</p>	

21030312 **Video Sync-Control Extension Cable**
Length 5 m, phone jack & socket 3.5 mm



01551000 **Gait Training Type M**
Module for gait training through visual cueing on h/p/cosmos mercury. Contains video projector with clamp and software extension for zebris FDM.



01551001 **Gait Training Type Q/P**
Module for gait training through visual cueing on h/p/cosmos quasar / pulsar / locomotion XL. Contains video projector with clamp and software extension for zebris FDM.



4 Video-Module

4.1 Connection to the FDM-T System

The FDM-T system can capture data simultaneously with up to 2 video cameras. For this purpose the **zebris SYNC**Cam is available as an accessory. Alternatively high-quality DV-camcorders with an external microphone socket can be used for video capture.

In order to capture video data synchronized with pressure data the camera has to be connected to the galvanically isolated **VIDEOSYNC** socket on the interface box.



4.1.1 Connection to the zebris SYNC

The zebris **SYNC**Cam uses its integrated synchronization flash to synchronize video data with pressure data.

For connecting the SYNC

REF 21030316Video Sync-Control Cable 5
 Length 5 m, both sides phone jack 3.5 mm



4.1.2 Connection scheme SYNCLightCam

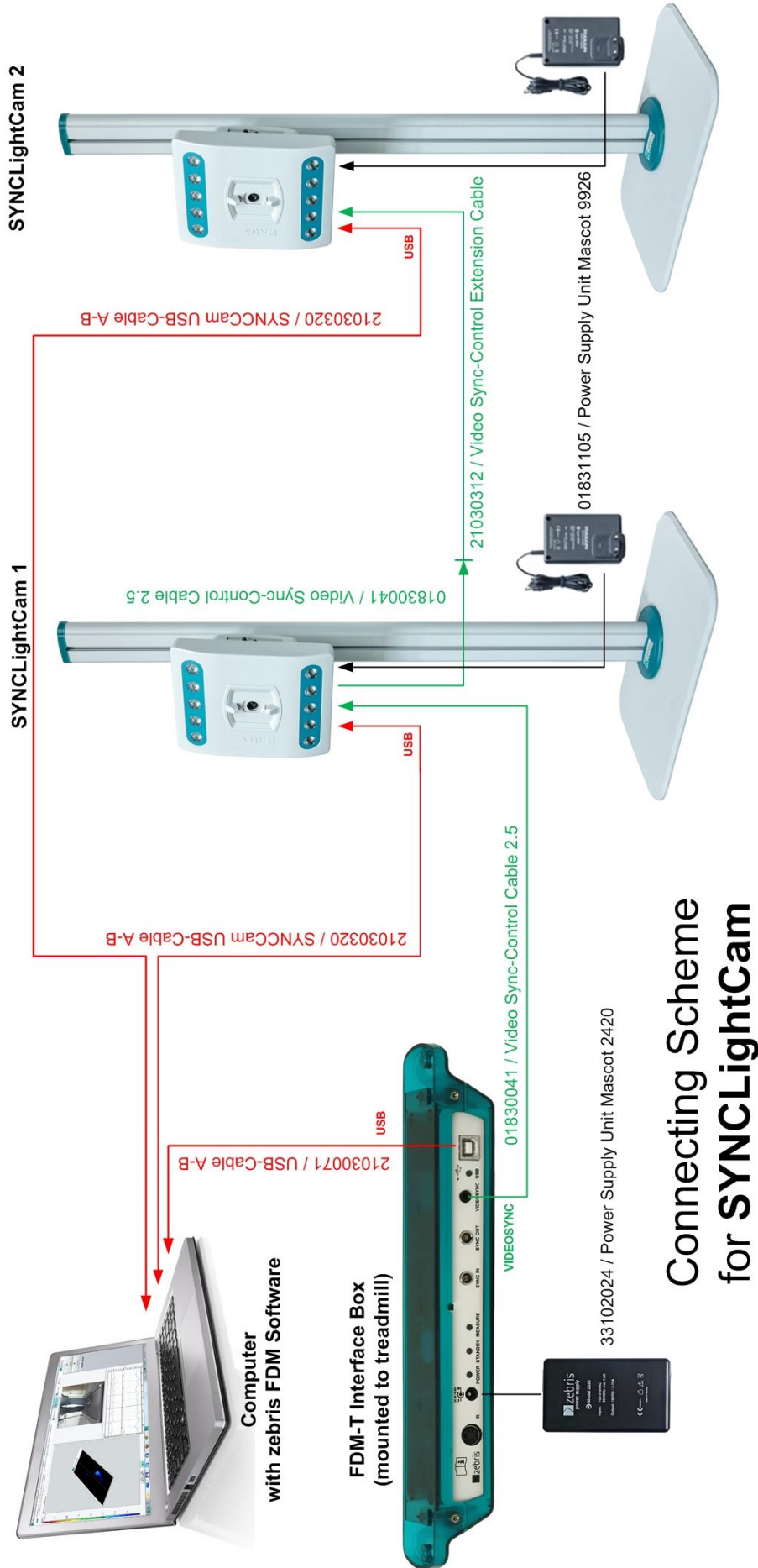

Connecting Scheme for SYNCLightCam

4.2 SYNCCam

The **SYNCCam** is an accessory of the FDM-T system and perfectly adapted to be used in combination with the pressure distribution measurement. All adjustments of the camera are carried out via hardware setup integrated to the zebris FDM Software. The camera is connected to the PC by a USB cable of type A-B included within the shipment.

The camera is equipped with ¼ inch tripod threads and can be adapted to zebris tripods as well as commercially available camera tripods.



The Sync-LEDs are flashing when the camera is disconnected from the USB port. Therefore it is strongly advised not to look directly into the camera when it is disconnected in order to avoid dazzling.

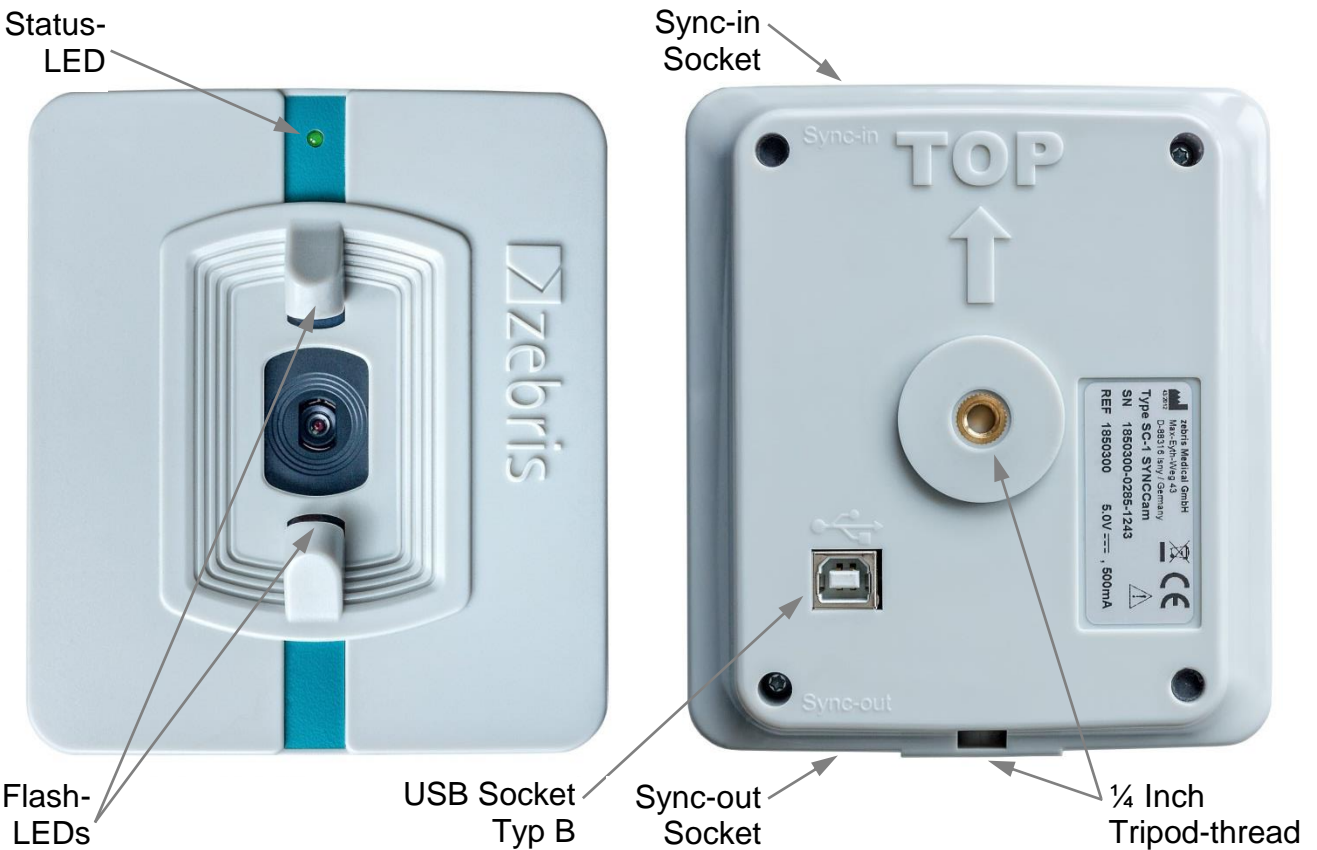

Technical Specifications

REF	01540190
Dimensions	110 x 125 x 15 mm (L x W x H)
Weight	approx. 190 g
Power Supply	USB (5 V DC / 500 mA)
Resolution	1920 x 1080 Pixel (Full-HD) / Autofocus
Frame Rate	30 Hz
Synchronization	LED-Flash triggered by Sync-IN socket
Mounting	¼ Inch tripod-thread at bottom and back side



In order to maintain undisturbed transmission of the video signal it is mandatory to use high quality USB cables.

Please, only use cables supplied or recommended by zebris for connecting SYNCCam and PC.

4.3 SYNCLightCam – Variant 30 Hz

The **SYNCLightCam** is an accessory of the FDM-T system and perfectly adapted to be used in combination with the pressure distribution measurement. All adjustments of the camera are carried out via hardware setup integrated to the zebris FDM Software. The camera is connected to the PC by a USB cable of type A-B included within the shipment.

The **SYNCLightCam** is equipped with ¼ inch tripod threads and can be adapted to zebris tripods as well as commercially available camera tripods.



WARNING

The Sync-LEDs are flashing when the camera is disconnected from the USB port. Therefore it is strongly advised not to look directly into the camera when it is disconnected in order to avoid dazzling.

Furthermore contains the SYNCLightCam as an integral solution, the LED video illumination.

In order to produce well lighted and tack sharp video captures it is essential to maintain perfect lighting conditions at the patient's side. Only with adequate lighting conditions video cameras can work with shutter times short enough to freeze fast movements and capture sharp images.

This solution is perfectly matched on the interaction with the FDM-T system and can be regulated infinitely in its brightness.

The integrated synchronization unit automatically switches the lights on at the start of a measurement and turns them off again after stopping it.

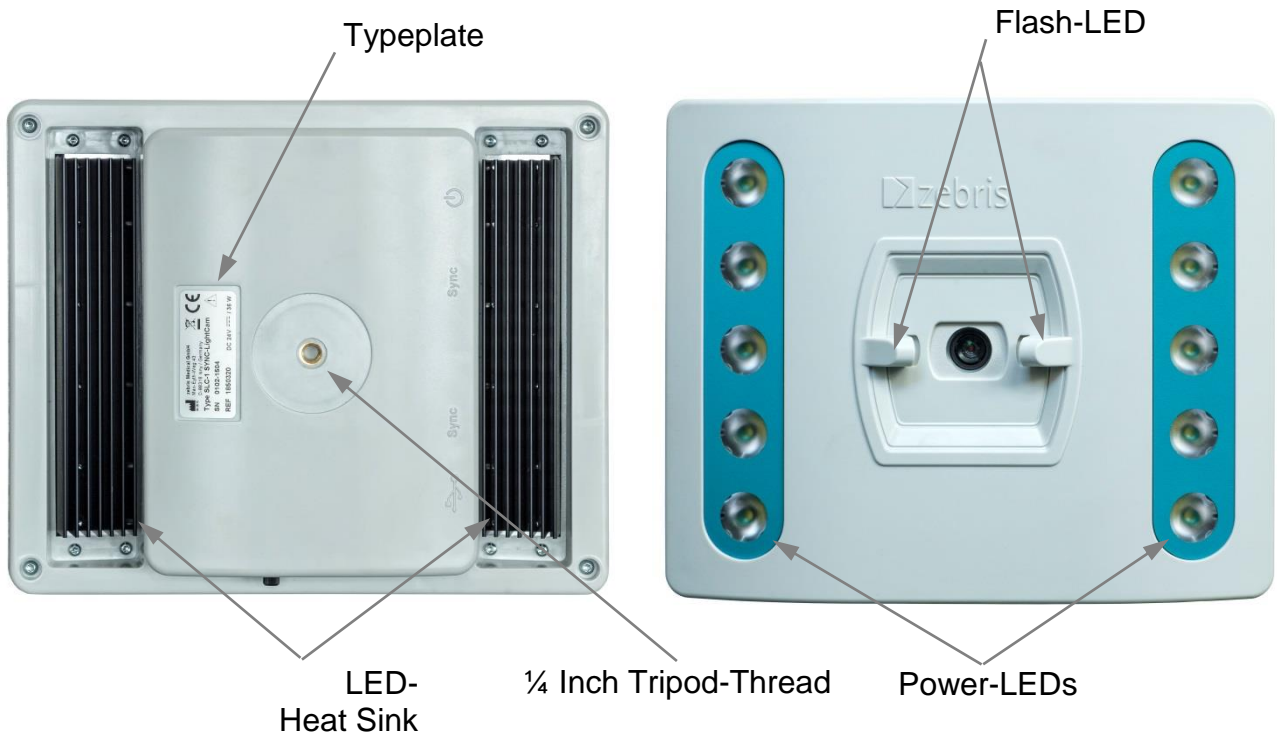

NOTE

In order to ensure failure-free operation of the SYNCLights it is mandatory to keep the black heat sinks at their back side uncovered and well air circulated at all times.

Technical Specifications

REF	01540194/ Variant 30 Hz
Dimensions	220 x 183 x 80mm (B x H x T)
Weight	ca. 790g
Power Supply	24V / 36W
Resolution	1920 x 1080 Pixel (Full-HD) / Autofocus
Frame Rate	30 Hz
Light Colour / Light	Current 6200 K / 1550 Lumen
Light Automatic	LED-Light switched on-/off by platform measurement
Synchronization	LED-Flash triggered by Sync-IN socket
Mounting	¼ Inch tripod-thread at bottom and back side

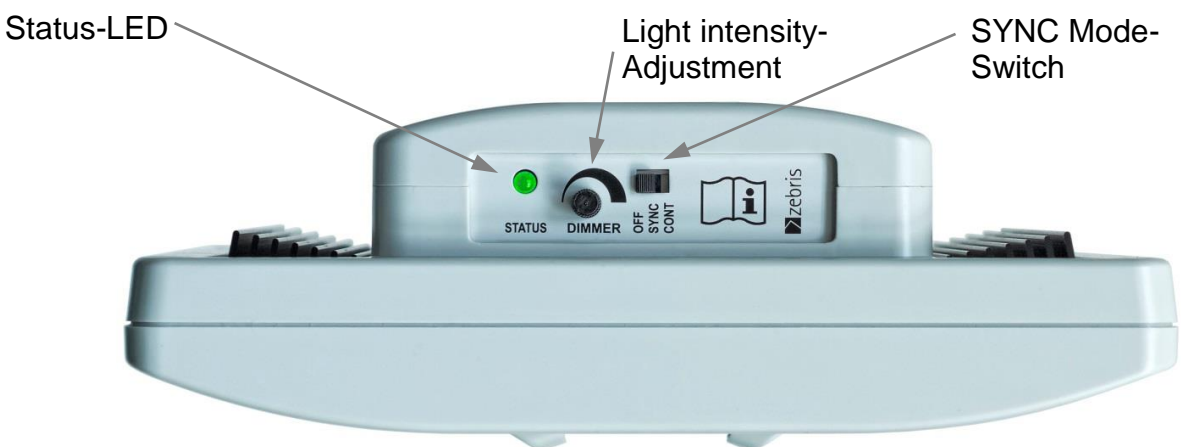

NOTE

In order to maintain undisturbed transmission of the video signal it is mandatory to use high quality USB cables.

Please, only use cables supplied or recommended by zebriS for connecting SYNCcam and PC.

4.4 SYNCLightCam HS – Variant 120 Hz

The **SYNCLightCam HS** is an accessory of the FDM-T system and perfectly adapted to be used in combination with the pressure distribution measurement. All adjustments of the camera are carried out via hardware setup integrated to the zebris FDM Software. The camera is connected to the PC by a USB cable of type A-B included within the shipment.

The **SYNCLightCam HS** is equipped with ¼ inch tripod threads and can be adapted to zebris tripods as well as commercially available camera tripods.

Furthermore contains the SYNCLightCam HS as an integral solution, the LED video illumination.

In order to produce well lighted and tack sharp video captures it is essential to maintain perfect lighting conditions at the patient's side. Only with adequate lighting conditions video cameras can work with shutter times short enough to freeze fast movements and capture sharp images.

This solution is perfectly matched on the interaction with the FDM-T system and can be regulated infinitely in its brightness.

The integrated synchronization unit automatically switches the lights on at the start of a measurement and turns them off again after stopping it.

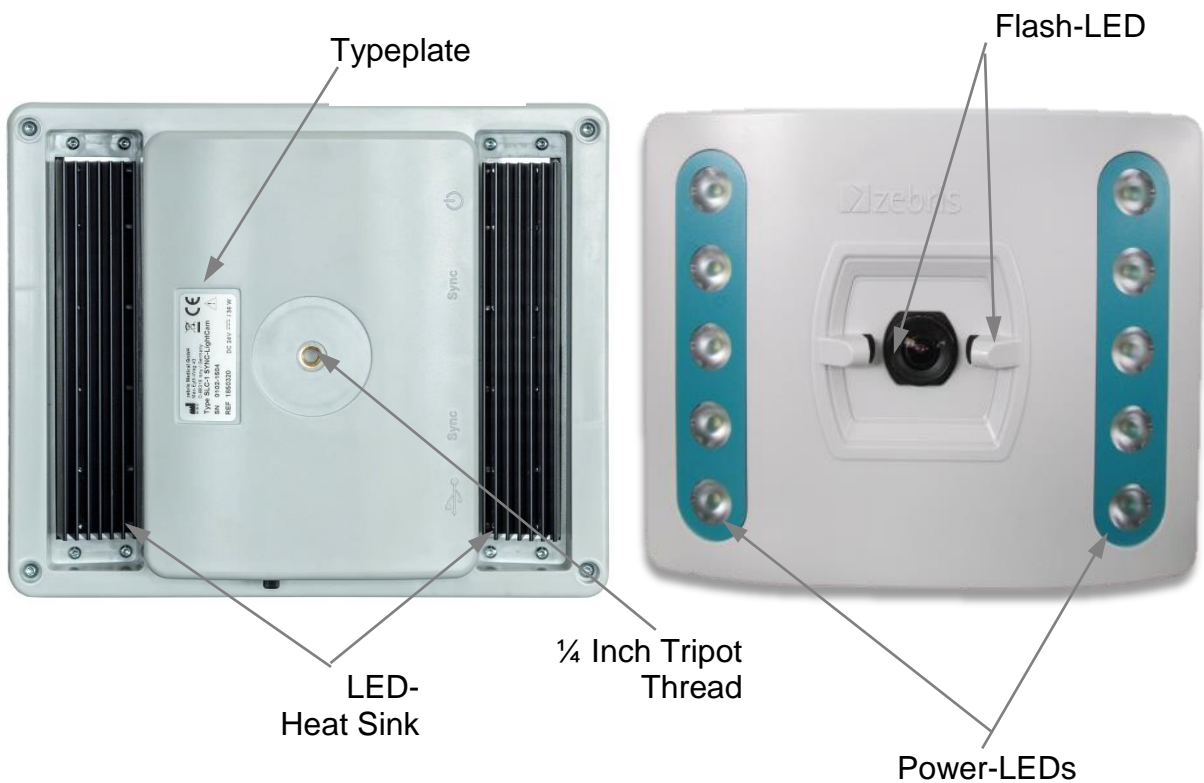

NOTE

In order to ensure failure-free operation of the SYNCLights it is mandatory to keep the black heat sinks at their back side uncovered and well air circulated at all times.

Technical Specifications

REF	01540194/ Variant 120 Hz
Dimensions	220 x 183 x 80mm (B x H x T)
Weight	ca. 790g
Power Supply	24V / 36W
Resolution	1920 x 1080 Pixel (Full-HD) / Autofocus
Frame Rate	120 Hz
Light Colour / Light	Current 6200 K / 1550 Lumen
Light Automatic	LED-Light switched on-/off by platform measurement
Synchronization	VIDEOSYNC
Mounting	¼ Inch tripod-thread at bottom and back side

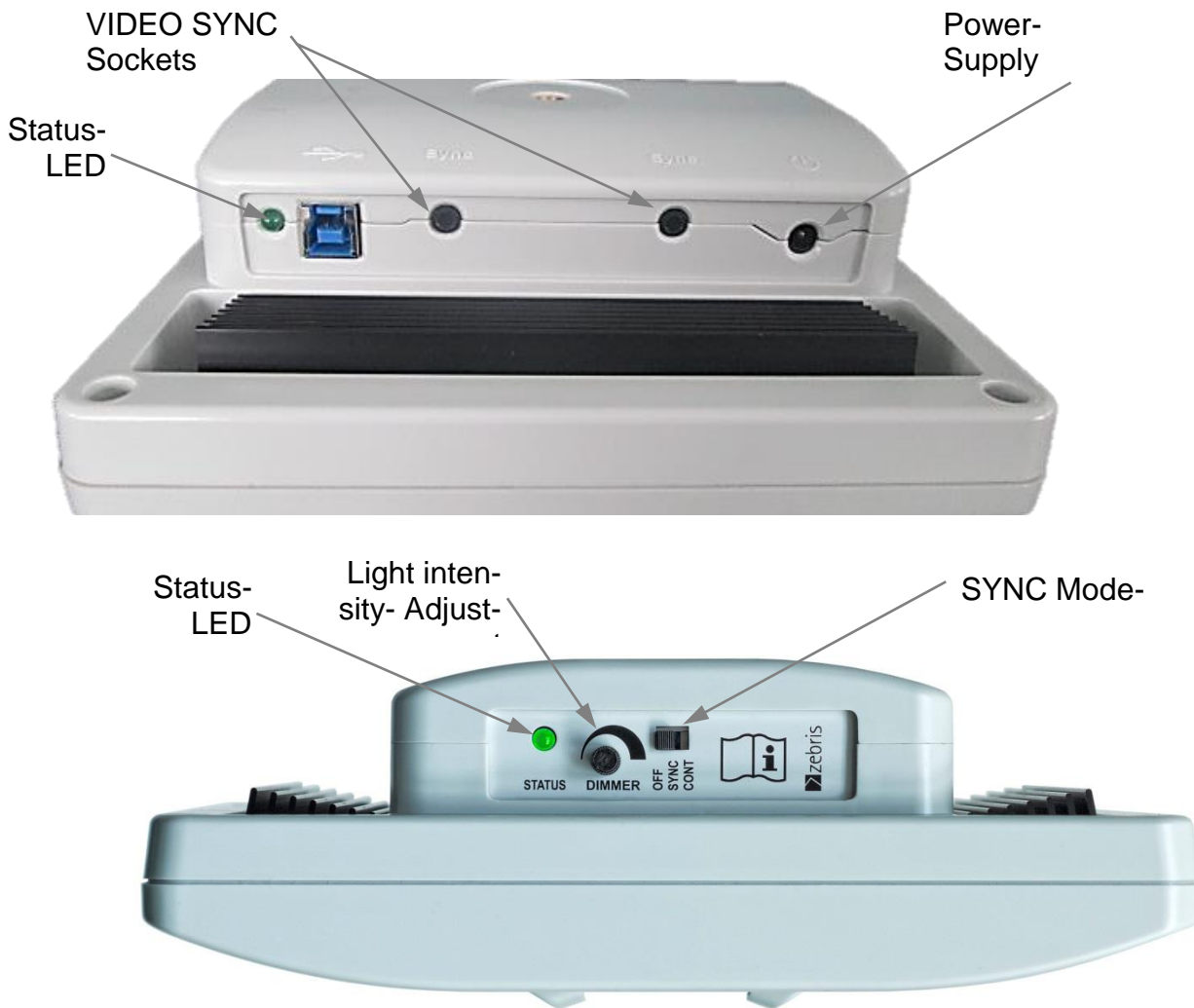

NOTE

In order to maintain undisturbed transmission of the video signal it is mandatory to use high quality USB cables.

Please, only use cables supplied or recommended by zebris for connecting SYNCcam and PC.



NOTE

The SYNCLightCam HS cameras are industrial cameras and thus intended for continuous operation. It is NOT a „plug and play“ device. For this reason, it is necessary to switch the cameras on the SYNC mode switch to “off” before the measuring PC is switched off. During the switch-on process, please first fully boot PC and Windows and then switch the camera to “SYNC” or “CONT” on the SYNC mode switch.

Interpretation of the STATUS-LED

- Green** Device is ready for use or in operation.
- Orange** The orange colour indicates when the maximum operation temperature has been reached. At this point the operation current is reduced automatically (which results in reduced brightness) in order to prevent the SYNCLight plus from being damaged by excessive heat.

Power Supply Unit

For operation of the SYNCLight plus a power supply unit needs to be connected.

REF 33102220

Input	Output	Cable	Length
100 – 240 V AC	24 V DC	DC-Lead	1.7 m
50 – 60 Hz	40 W	Mains Lead	Plug Adapter

SYNC-Modus

Modes	Characteristics
-------	-----------------

**VIDEO
SYNC IN**

ESD - protected, voltage reversal proof input
Input resistance: 38 kΩ (AC)
Signal-Level: AC
Trigger Level: 15 mV

Pin Assignment

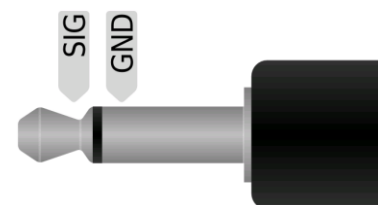

5 Gait Training Module

For the gait training and the feedback training (virtual Forestwalk) a projector unit can be mounted to the treadmill frame. In order to accomplish adapters individually engineered for different treadmill types are necessary. The assembly of the available adapter types is described below.



NOTE

For setup, installation and safety related instructions of the projector please refer to the user manual of the projector manufacturer.

The projector is connected directly to the corresponding hardware interface (mostly HDMI). The projection during gait training is controlled by the gait training module of the zebris FDM software.



WARNING

During long periods of operation, the projector can become very hot in the area of the lamp and at the air outlet openings and thus should not be touched.



WARNING

In order to minimise the risk of falling and to prolong the lifetime of the projection lamp, the projector should only be switched on during the gait training and otherwise be switched off.



WARNING

With treadmills featuring an inverse driving direction, the projector must be separated from the mains before activating the inverse driving direction.

As with installed projector and activated inverse driving direction a higher risk of injury through falling exists because of the projector, a safety (safety bow with chest strap) should always be used with treadmills featuring an inverse driving direction.

5.1 Gait Training Type M (h/p/cosmos mercury)

Accessories for gait training through visual cueing with treadmill type h/p/cosmos mercury.

Fixing the projector mount

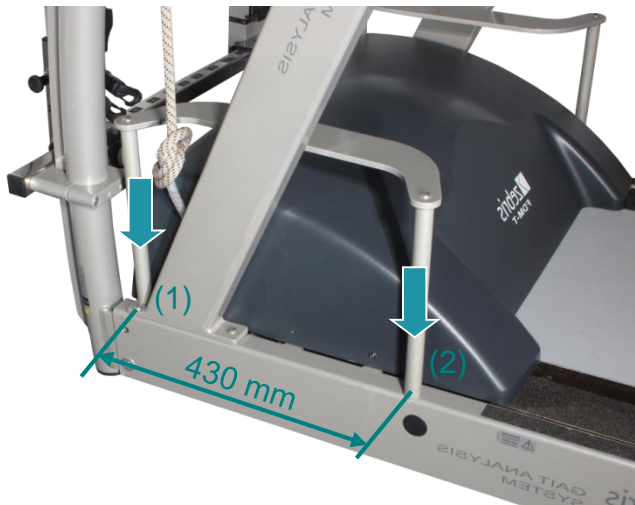

Required tools:

- Allen Key 6 mm / 8 mm
- Drill Ø 5.0 mm
- Tread Cutter M6

First remove screw (1) of the treadmill's handrail.

For attachment of the rear fixation pole a tapped hole (2) has to be drilled at a distance of 430 mm from the hole in front of the handrail (1).

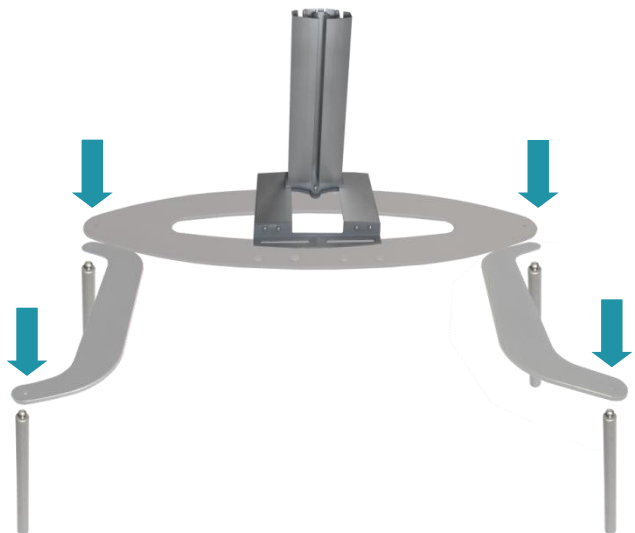

Next the components of the adapter have to be assembled in the sequence illustrated left hand side.

First screw the four fixation poles to the treadmill frame and attach the C-shaped connection pieces to the poles with the screws supplied.

Then attach the oval cross member with two screws.

At last attach the projector's stand to the cross member with the screws supplied.

For the final assembly of the projector to its stand, please refer to the user manual of the projector manufacturer.



WARNING

Please regularly check (recommended after 25 operating hours each) that all screws of the handrail and projector mount are tightly fastened.

5.2 Gait Training Type Q and (h/p/cosmos quasar)

Accessories for gait training through visual cueing with treadmill type h/p/cosmos quasar.

Fixing the projector mount

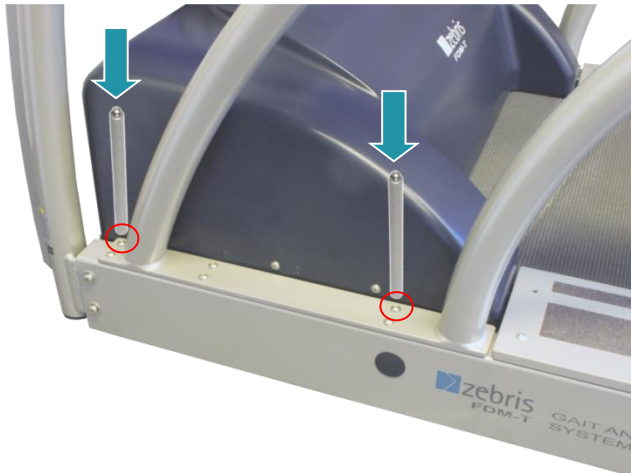

Required tools:

- Allen Key 6 mm
- Phillips Screw Driver

First remove the screws marked in red from the hand rails of the treadmill.

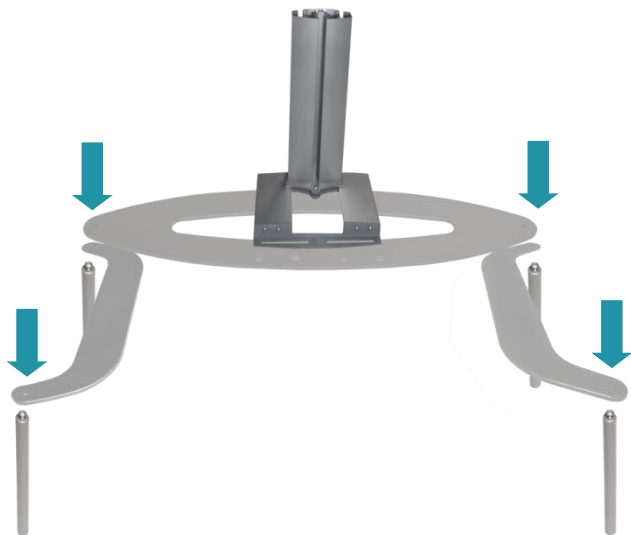

Next the components of the adapter have to be assembled in the sequence illustrated on the left hand side.

First screw the four fixations poles to the treadmill frame and attach the C-shaped beams to the poles with the screws supplied.

Then attach the oval cross beam with two screws.

At last attach the projector's stand to the cross beam with the screws supplied.

For the final assembly of the projector to its stand, please refer to the user manual of the projector manufacturer.



WARNING

Please regularly check (recommended after 25 operating hours each) that all screws of the handrail and projector mount are tightly fastened.

6 Setup and Operation of the FDM-T System

6.1 Positioning of the measuring system



NOTE

For setup, installation and safety related instructions of the treadmill please refer to the user manual of the treadmill manufacturer.



WARNING

A safety zone of at least 2 m in length and 1 m in width must be kept free directly behind the treadmill. No items may be left in this zone (video camera, etc.).



WARNING

It is strictly prohibited to embed the treadmill in the floor in order to reduce access height. This way of installation might create a highly dangerous capture area at the rear guide pulley of the treadmill. The manufacturer expressly will undertake no liability for injuries to any person when the treadmill is operated under such condition!

- Preferably place a gym mat or other padding in the safety zone behind the treadmill in order to soften falls.
- The floor where the device is installed must be absolutely even and horizontal.
- The belt of the treadmill must be checked after installation, or if the treadmill is moved to another place, and adjusted if required. (Please refer to the user manual of the treadmill manufacturer for this purpose.)
- Set up the measuring system such that the socket for the mains connection is easily accessible at all times and the device can be disconnected from the power supply.
- Once the treadmill has been installed securely and is horizontally leveled, it can be connected to a suitable mains socket and set into operation.

For the commissioning of the FDM-T system for the stance and gait analysis, the associated power supply, a USB cable type A-B as well as the installation CD with the zebris FDM application software are necessary. All components are included in the scope of delivery of the FDM-T measuring system.

All cable connections of the FDM-T sensor are integrated in the interface box, which is positioned on the underside of the treadmill frame.

6.2 Installation of the detachable cable guard

The detachable cable guard will be attached to the interface box by means of the screws (3 x 6 mm) delivered with the measuring system as shown in the illustrations below.

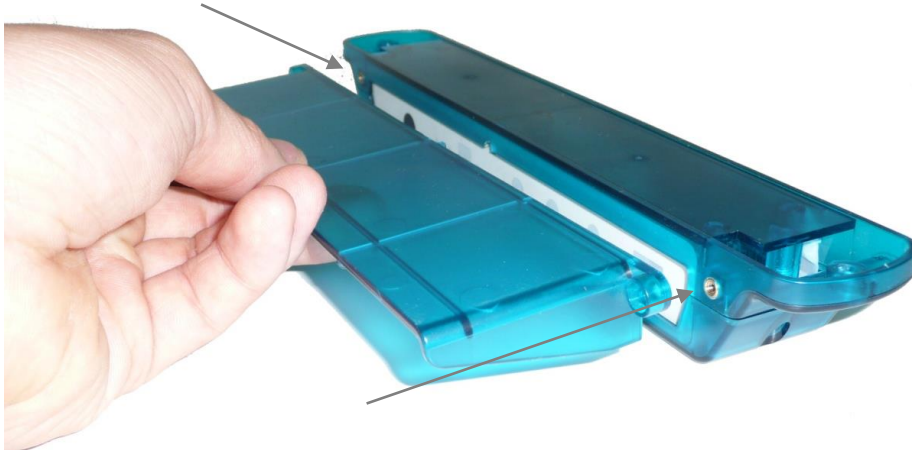

6.3 Connection of the measuring system to mains supply

6.3.1 Power supply of the FDM-T Sensors

For connecting the FDM-T sensor to the power supply, connect the power supply unit to the mains socket and the power socket on the interface box.



WARNING

For operating the FDM-T sensor, exclusively use the power adapter approved by zebris, which is suitable for the power supply of all FDM-T systems.

REF.-No. 33102024 / Mascot type 2420

Input	Output	Cable	Length
100 - 240 V AC	16 V DC	Mains lead	1.7 m
50 - 60 Hz	60 W	DC lead	5 m

Pin arrangement / polarity



NOTE

Before connecting the measuring system to the power supply, compare the nameplate specifications on the power supply unit and on the treadmill regarding the mains voltage and mains frequency, with the local characteristics. Connect only if they are compatible.



WARNING

Before connecting or using the measuring system, carry out a visual check of the power supply unit, power supply cable and socket, as well as the earthing contacts. Damaged power supply units, cables or plug and socket devices are to be replaced immediately by an authorized person.

6.3.2 Connection of the System

For connecting the treadmill to the power supply, please additionally observe the respective instructions in the user manual provided by the treadmill manufacturer.



WARNING

The connection of the treadmill and the FDM-T power supply unit must be done at a separate wall socket. It is not permissible to use extension cables and/or multiple sockets.



WARNING

Set all connection cables in a way that prevents patients, or persons taking part in the measuring procedure from tripping over them or damaging them mechanically. For this purpose, run the cables using cable protections or if necessary fasten the cables with adhesive tape to the floor.

6.4 Computer Requirements

The requirements for the PC are specified in the user manual of the zebris FDM software.



WARNING

If the computer is not supplied with the measuring system, the manufacturer shall not be held liable for any damage or malfunctions that result from defective software installation or incompatible hardware. Should additional hardware be built into the computer or third party software be installed, the manufacturer shall not be liable for any malfunctions or damage occurring thereof.

6.5 Installing the zebris FDM software

If your measuring system is delivered without PC/laptop, please install the application software before connecting the measuring system to the computer. Please find information on the installation in the user manual of the zebris FDM software.



Note

Please make absolutely sure that you have installed the zebris software before connecting the FDM-T sensor to the computer using the USB cable.

If the FDM-T sensor is connected without installing the software first, problems when installing the device driver may occur and the system does not work.



Note

Should problems with the hardware driver of the FDM-T platform occur then disconnect the platform from the PC and restart it. Now proceed with installing the zebrisFDM software again and reestablish the USB connection.

Finally connect the Interface box and a free USB interface of your computer by using the provided USB cable. Your measuring system is now ready for use. The control of a measurement exclusively is carried out via the zebris FDM software. Therefore, please carefully read the zebris FDM user manual.

6.6 How to switch the FDM-T sensor On/Off

The FDM-T sensor is switched on and off by software control as soon as the zebris FDM software on the PC is started or shut down.

If the device has been connected correctly, the green power LED lights up on the interface box. For further details on preparing a measurement platform, please see the section "Recommendations for recording data".

6.7 Setting the system out of operation

In order to set the system out of operation, please close the zebris FDM software first, then exit the Windows operating system and shut down the PC. In the next step disconnect the power supply unit of the FDM sensor and the treadmill from mains supply.

6.8 Recommendations for recording

There are a few things one should bear in mind for obtaining significant measuring results using the FDM-T system. The following points relate to the data recording of a person while walking and describe the ideal measuring situation.

6.8.1 Treadmill Analysis

Walking on the treadmill is unfamiliar to most people and takes a certain time to get used to it. It is therefore of advantage to familiarize the test person with this new type of externally controlled movement of the treadmill before recording any data.

6.8.2 Data Recording

Also observe the test person during the measurement. Only use data recordings where the foot does not extend beyond the sensor surface during roll-off.

6.8.3 Walking Speed

The walking speed during the measurement should correspond to the person's normal walking speed. It usually takes a few minutes for the test persons to be relaxed enough for finding their normal movement pattern again. It may well be that their speed increases during the measurement. This should be avoided by carefully making sure that the test person feels at ease before the measuring begins. During the data recording the speed should not fluctuate by more than 5%.

6.8.4 Posture

The test person should adopt a relaxed posture, with the arms swinging in a natural way. Make sure that the test person looks straight ahead and not to the ground, the treadmill or the screen, as this can influence the natural gait pattern.



WARNING

Persons who are unsteady on their feet should make sure to hold onto the handrail while walking on the treadmill in order to avoid any danger of stumbling!

Basically, the safety features of the treadmill have to be used (safety clip for emergency stop, crash bar).

6.8.5 Weals

Studies have proven that the peak plantar pressure is increased by 30 % through calluses on the foot (P.R. Cavanagh, *The Foot* (1994) 4, 123-135). This information should be taken into account during the measuring procedure.

7 Maintenance and Safety Inspections



- Scheduled maintenance of the system is essential in order to prevent damage and guarantees the safety of the device. All processes concerning maintenance and disinfection of the device should be carried out regularly.
- Should any malfunctions and/or defects be determined or suspected, the device must be put out of operation immediately, marked as "Out Of Service" and prevented from being used by removing the mains cable. In such case be sure to contact the manufacturer or an authorized sales partner.
- All maintenance and repair work of the measuring system or of single components that goes beyond the activities described in this user manual must exclusively be carried out by zebris Medical GmbH or a person who has been explicitly authorized by zebris to do so.
- Be sure to switch off the measuring system and disconnect it from mains supply before starting any maintenance work.

7.1 General Maintenance Procedures

- Immediate maintenance procedures are to be carried out if:



- a) fluid enters the device.
 - b) cable or cable connections have been damaged.
 - c) covers have been damaged or have fallen off.
 - d) the running belt shows any signs of wear or cracks.
 - e) the running belt no longer runs centrally.
 - f) the sliding surface underneath the treadmill belt is no longer sufficiently lubricated.
 - g) a malfunction or a defect is suspected or has been detected.
- Check regularly (approx. every 25 operating hours) whether all the screws are tight, the belt tension is sufficient and the running belt is correctly centered. For the exact sequence of these maintenance procedures, please refer to the user manual supplied by the treadmill manufacturer.
 - In order to keep the friction between the running belt and the FDM-T sensor as low as possible, the system must be lubricated at regular intervals with silicone oil. zebris recommends lubricating at least every 6 months. For detailed information concerning the lubrication procedure please refer to the user manual of the treadmill manufacturer.
 - Should the treadmill be relocated to another place, it is necessary to check that the belt is running correctly. The belt should always run centrally on the rear guide pulley.
 - After a longer period of use, or if the adjustment is suboptimal, the belt can loosen and with every step, a jolt can occur between the drive shaft and the belt. This can possibly influence the measuring result of the system. Therefore control the belt tension regularly in accordance with the instructions supplied by the treadmill manufacturer.
 - Should you hear "mechanical knocking sounds" during operation, check whether the device is standing level on the ground as incorrectly adjusted feet may often cause knocking noises.

7.2 Mandatory periodic inspections and STK

- For maintaining the correct state of the electrical equipment, checks and technical safety inspections have to be carried out repeatedly (e.g. within Germany, acc. to BGV A3, and accident prevention regulations and technical safety tests according to the Medical Device Operating Regulations). Here it should be noted that standard regulations for electrical devices are concerned here and not measures that are specific to zebris. 
- Before each use of the measuring system it is recommended for safety reasons to check the correct state of all the connection cables, as well as the mains cable, mains plug and mains socket. Should certain parts be damaged, they must be replaced before continuing to use the measuring system.
- If the type plate or other important labels (e.g. warning notes) are damaged or illegible they have to be replaced by the manufacturer for safety reasons.
- Each treadmill has an anti-slip area alongside the running surface on both sides. These stepping areas offer a firm hold when getting off the treadmill in emergencies. Check this anti-slip area at regular intervals and replace it immediately if it shows signs of wear.

7.4 Maintenance of the FDM-T Sensor

7.4.1 Control Procedures



WARNING

The measuring system must be checked at regular intervals to ensure its correct function and patient safety.

In case the running belt has been exposed to hard knocks or heavy items have fallen onto it, the surface of the FDM-T sensor has to be checked for damaging (cracks, dents, and scratches on the surface). If visible damages are detected, no further measurements must be carried out.

After carrying out a zero measurement, no measuring values may be shown for a condition without any load. In addition, the pressure distribution images are to be checked regularly for untypical measuring patterns. These include above all, line or column-shaped measuring patterns deviating from the surrounding values.



NOTE

In order to guarantee the correct functioning of the speedometer in the long term, the central position of the belt must be checked monthly according to the instructions supplied by the treadmill manufacturer, and readjusted, if required.

Whenever faults occur or in case of doubt, the manufacturer or sales partner authorized by zebris must always be contacted.

7.4.2 Calibration Procedures

The measuring accuracy of the FDM-T sensors is to be checked from time to time using a defined application of pressure.

To do so, the user can stand on the platform on one foot. Provided that he knows his body-weight the platform must then show the approximate body weight, taking the force of gravity, the sensors at the edges that may not be under full pressure, and the measuring tolerance into consideration.

In case the measuring results show deviations larger than $> \pm 5 \%$ of the full measuring range, a recalibration by the technical service of zebris Medical is required.

If any doubt exists about the measuring accuracy of the FDM-T sensor, it is recommended to have the pressure distribution measuring sensors checked and re-calibrated by zebris, in order to ensure the specified measuring accuracy.



NOTE

On request, service instructions for the assembly and disassembly of the FDM-T sensor can be supplied for various treadmill types, so that maintenance and repair work can be carried out by trained personnel on site.

7.5 Troubleshooting

In the case of faults, please check the following points first:

- ✓ Are the FDM-T sensor and treadmill connected correctly to the mains?
(Green Power LED on the interface box and power switch on the treadmill lights up.)
- ✓ Is the USB connection between the interface box and the measuring PC correct?
(Green USB LED lights up when the USB is connected to the PC and the device driver is correctly installed.)
- ✓ Are all the other components of the measuring system (infrared synchronization with zebris DAB Bluetooth, video camera) connected correctly?



NOTE

For additional information on error messages and their troubleshooting, please refer to the user manual for the zebris FDM software.

Check list for noting down error messages



NOTE

In order to provide best possible support in the event of system malfunctions our service personnel will need the following information:

- ✓ Device type + serial no. of the FDM-T sensor and treadmill
The serial no. can be found on the type plates on the frame of the treadmill or on the back of the interface box.
- ✓ Version of the zebris FDM Software
- ✓ Data on the operating system of your measuring PC
e.g. Windows 7 Service Pack 1
(can be found under Start >> Properties>> Control Panel>> System)
- ✓ Further components connected to the measuring system
e.g. infrared synchronization (IR) with zebris DAB Bluetooth, video camera
- ✓ List of all the USB devices connected to the measuring PC
e.g. mouse, printer, other measuring systems, etc.
- ✓ Screenshot of the error message or exact wording
e.g. "EMG adapter not found."
- ✓ User's procedure leading to the error message
e.g. measurement "Type A" started, then clicked on button "B", then movement "C" carried out, switch-over to function "D", when switching back the described error message occurred.

7.6 Cleaning and disinfection

7.6.1 Cleaning Procedure

The treadmill and accessories are cleaned with a moist cloth while the device is switched off and the mains plug taken out.



NOTE

Do not use any aggressive agents to clean the measuring system..



WARNING

Please make absolutely sure to switch off the device and pull the mains plug out of the socket before you commence disinfecting and cleaning.

7.6.2 Disinfection Procedure

The treadmill can be disinfected by wiping over with suitable detergents. Best wipe the running belt or other parts of the treadmill with a cloth soaked with disinfection liquid. In order to remove more resistant contamination directly spray the running belt with disinfection liquid.

Recommended disinfection agent:

Composition approx. 25% ethanol, 35% propanol

E.g. Mikrozyd Liquid / Schülke & Mayr or similar solutions



NOTE

If you apply disinfectant be sure to strictly follow the recommendations provided by the manufacturer of the disinfectant. Especially consider the rules concerning the disinfectant's recommended duration of impact.



WARNING

On no account bring any disinfection fluids or other liquids in direct contact with the FDM-T sensor when cleaning.

Should any liquid enter the platform it is likely to be damaged irreparably.



WARNING

Fluids required for disinfecting and cleaning must be stored, prepared and kept ready for use exclusively in the containers provided, in order to avoid them being mistaken for other fluids.



NOTE

For confirmation that disinfection has been carried out, it is advised to place a visible sign on the running surface reading "disinfected".

7.7 Disposal

7.7.1 Packaging

All the transport packaging supplied by zebris can be recycled within Germany via the local recycling depots. In order to guarantee the re-use of the recyclables contained in the packaging, zebris Medical GmbH participates in the Dual System ZENTEK which takes over the proper disposal of the packaging.



Please find information concerning the disposal of the treadmill in the Operating Instructions supplied by the treadmill manufacturer.

7.7.2 WEEE-Directive

This symbol indicates that according to the directive on waste electrical and electronic equipment (2012/19/EEC) the product must not be disposed by means of the domestic waste system. Within Europe this device must be forwarded to a specific waste disposal system.

For this purpose the measuring system can be returned to zebris Medical GmbH at the end of its service life at the customer's own expense and will be forwarded to special recycling companies without any further costs and refund.

The improper use of old devices (measuring systems) could lead to negative effects for the environment and the public health because of potential hazardous materials which are frequently contained within electric and electronic devices. Additionally with the proper disposal of this product you will contribute to the effective use of natural resources.

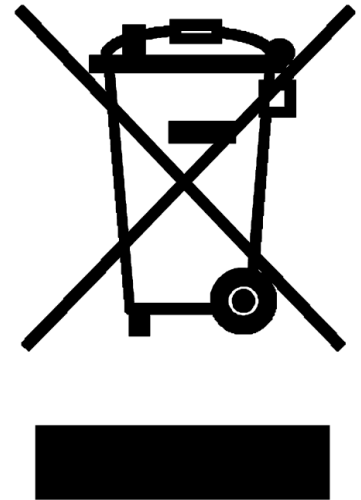

7.7.3 Accumulators and batteries

Accumulators and batteries must not be disposed of with domestic waste! In the interest of environmental protection, the consumer is legally obliged (battery regulation) to return old and used batteries. Used accumulators and batteries can be disposed of at the collecting points of the community or where batteries of the relevant kind are sold. For consumers, the batteries are taken back free of charge.