

Specifications and Operating Instructions



FDM-T
SYSTEM  zebris

Inhalt

1	USER NOTES	4
1.1	INTRODUCTION	4
1.2	MANUFACTURER	5
1.3	LAYOUT OF THE USER MANUAL FOR THE FDM-T SYSTEM	5
1.4	CONVENTIONS AND SYMBOLS USED	6
2	APPLICATION AND SAFETY	7
2.1	INTENDED USE	7
2.1.1	INDICATIONS	7
2.1.2	CONTRAINDICATIONS	7
2.2	SAFETY	8
2.2.1	ENVIRONMENTAL CONDITIONS	8
2.2.2	STORAGE AND TRANSPORT	8
2.2.3	USER OBLIGATIONS	9
2.2.4	GENERAL SAFETY INSTRUCTIONS	10
2.2.5	SAFETY INSTRUCTIONS FOR THE TREADMILL	11
2.2.6	PROHIBITED USE	12
3	PRODUCT DESCRIPTION	13
3.1	SYSTEM COMPONENTS	13
3.2	SPECIFICATIONS FDM-T SENSOR	13
3.3	TECHNICAL SPECIFICATIONS FDM-T MEASURING SYSTEMS	13
3.4	MEASURING PRINCIPLE FDM-T SYSTEMS	21
3.5	CONTROLS AND CONNECTORS	22
3.6	LED INDICATOR LIGHTS OF THE INTERFACE BOX	22
3.7	ZEBRIS SYNC	23
3.7.1	SYNCHRONIZATION INPUT (SYNC-IN)	24
3.7.2	SYNCHRONIZATION OUTPUT (SYNC-OUT)	25
3.7.3	IR-SYNCHRONIZATION BOX FOR DAB-BLUETOOTH (ZEBRIS EMG)	26
3.8	SPARE PARTS FDM-T SYSTEM	27
3.9	ACCESSORIES FDM-T MEASURING SYSTEM	27
4	VIDEO-MODULE	31
4.1	CONNECTION TO THE FDM-T SYSTEM	31
4.1.1	CONNECTION TO THE ZEBRIS SYNC CAM	31
4.1.2	CONNECTION TO DV- CAMCORDERS WITH INPUT FOR EXTERNAL MICROPHONE	31
4.1.3	CONNECTION SCHEME SYNCLIGHT CAM	32
4.1.4	CONNECTION SCHEME SYNCCAM UND SYNCLIGHT	33
4.1.5	CONNECTION SCHEME SYNCCAM UND SYNCLIGHT PLUS	34
4.2	SYNCCAM	35
4.3	SYNCLIGHT CAM	36
4.4	LED VIDEO LIGHTS (SYNCLIGHT / SYNCLIGHT PLUS)	39
4.4.1	SYNCLIGHT	40
4.4.2	SYNCLIGHT PLUS	41
5	GAIT TRAINING MODULE	44
5.1	GAIT TRAINING TYPE M AND L (H/P/COSMOS MERCURY UND LOCOMOTION)	45
5.2	GAIT TRAINING TYPE Q AND P (H/P/COSMOS QUASAR UND PULSAR)	46
5.3	GAIT TRAINING TYPE D (DAUM ERGO_RUN)	47
6	SETUP AND OPERATION OF THE FDM-T SYSTEM	48
6.1	POSITIONING OF THE MEASURING SYSTEM	48
6.2	INSTALLATION OF THE DETACHABLE CABLE GUARD	49
6.3	CONNECTION OF THE MEASURING SYSTEM TO MAINS SUPPLY	50
6.3.1	POWER SUPPLY OF THE FDM-T SENSORS	50
6.3.2	CONNECTION OF THE SYSTEM	51
6.4	COMPUTER REQUIREMENTS	52
6.5	INSTALLING THE ZEBRIS FDM SOFTWARE	53
6.6	HOW TO SWITCH THE FDM-T SENSOR ON/OFF	53
6.7	SETTING THE SYSTEM OUT OF OPERATION	53

6.8	RECOMMENDATIONS FOR RECORDING	54
6.8.1	TREADMILL ANALYSIS	54
6.8.2	DATA RECORDING	54
6.8.3	WALKING SPEED	54
6.8.4	POSTURE	54
6.8.5	WEALS.....	54
7	MAINTENANCE AND SAFETY INSPECTIONS	55
7.1	GENERAL MAINTENANCE PROCEDURES.....	55
7.2	MANDATORY PERIODIC INSPECTIONS AND STK	56
7.4	MAINTENANCE OF THE FDM-T SENSOR.....	57
7.4.1	CONTROL PROCEDURES	57
7.4.2	CALIBRATION PROCEDURES.....	57
7.5	TROUBLESHOOTING.....	58
7.6	CLEANING AND DISINFECTION.....	59
7.6.1	CLEANING PROCEDURE	59
7.6.2	DISINFECTION PROCEDURE.....	59
7.7	DISPOSAL	60
7.7.1	PACKAGING.....	60
7.7.2	WEEE-DIRECTIVE	60
7.7.3	ACCUMULATORS AND BATTERIES.....	60
8	SAFETY STANDARDS AND CLASSIFICATION OF THE SYSTEM	61
8.1	CLASSIFICATION ACC. TO ANNEX IX OF DIRECTIVE 93/42/EEC	61
8.2	SAFETY OF MEDICAL ELECTRICAL DEVICE.....	61
8.2.1	COUPLING OF THE FDM-T MEASURING SYSTEM WITH OTHER ELECTRICAL DEVICES.....	61
8.2.2	VICINITY OF THE PATIENT / TEST PERSON	62
8.2.3	USE OF MULTIPLE SOCKETS	63
8.3	ELECTROMAGNETIC COMPATIBILITY / MANUFACTURER'S DECLARATION	64
8.4	DECLARATION OF CONFORMITY MEDICAL LINE (M).....	67
8.5	DECLARATION OF CONFORMITY SPORTS LINE (S)	68

1 User Notes

1.1 Introduction

Dear Customers,

we are delighted that you have chosen a zebris product. Since 1987 zebris Medical GmbH has been developing and producing measuring systems for application in medicine, rehabilitation, diagnostics, sport and science, thereby satisfying high demands as regards technology, safety and functionality.

This user manual provides essential information for the setup of the system and suggests basic principles for preparing the measuring procedure and data recording. Please read these operating instructions carefully before installing the system and using for the first time, and keep them in a safe place directly next to the measuring system. The operating instructions constitute an integral part of the measuring system and will help you to operate the system in accordance with the regulations.

Non-compliance with the safety requirements described in the operating instructions can lead to hazardous situations. zebris Medical GmbH does not assume any liability for injury to personnel or patients, nor damage to the device caused by improper use of the measuring system for gait and stance analysis.

All information about the measuring system within this user manual has been collected, compiled and checked with the greatest possible care. Nevertheless a user manual may remain subject to printing errors, faults and changes. If you notice any errors in this manual, or should you have any suggestions for the improvement, we would be very grateful for giving us notice any time.

In the interest of continuous product development and improvement it may be possible that after release of this user manual the hardware or software configuration has been changed slightly. Therefore some illustrations may deviate in details from the product delivered.

We wish you every success during your work using your zebris measuring system.

Yours faithfully, zebris Medical GmbH

Copyright

This document and extracts taken from it may on no account be duplicated without the explicit consent of zebris Medical GmbH. The content of this document may on no account be used for purposes that have not undergone approval by zebris Medical GmbH. Any infringement of the copyright is a punishable offence.

© Copyright zebris Medical GmbH / All rights reserved.

1.2 Manufacturer

zebris Medical GmbH

Am Galgenbühl 14
D-88316 Isny im Allgäu
Deutschland

Web: www.zebris.de

Phone +49 (0)7562 9726 0

Telefax +49 (0)7562 9726 50

E-Mail info@zebris.de

1.3 Layout of the user manual for the FDM-T system

The FDM-T measuring system consists of a treadmill, the force distribution measuring sensors and the corresponding application software, including the PC. The sensors and treadmill can also be used completely independently of each other and feature a separate power supply and CE mark.

The user manual for the FDM-T measuring system therefore consists of several sections:

1. FDM-T specifications and hardware user manual
2. zebris FDM user manual for the application software
3. Specifications and user manual supplied by the treadmill manufacturer
4. User manual and specifications of accessories like projector or PC



NOTE

Please also be sure to adhere to the user manuals supplied by manufacturers of the treadmill and the accessories when setting the system into operation, while using it, maintaining it and transporting it.

The section FDM-T specifications and hardware user manual mainly contains information regarding the specifications and operation of the FDM-T force distribution measuring sensors and their safe operation in combination with the treadmill, as a measuring system. Instructions regarding the treadmill are restricted to the main safety and servicing measures.



WARNING

The exact adherence to the instructions in all sections of the operating instructions for the measuring system is a precondition for its intended use.

1.4 Conventions and Symbols Used



The green markings in the margin of the user manual denote new information about the product safety.



“**WARNING**” symbols indicate a potential hazard to the health and safety of the users and/or patients. The warnings describe the risks involved and those that can be avoided.



Note symbols indicate a potential hazard that can result in damage of the device. The notes explain the type of hazard and how it can be prevented.



The **CE mark** on the type plate confirms the conformity of the measuring system with the Directive 73/23/EEC and Directive 89/366/EEC (Low Voltage Directive and EMC Directive).



The **CE mark with reference number 0535** of notified body BSI (formerly EUROCAT) on the interface box as well as measuring sensors confirms the conformity of the system with the Directive 93/42/EEC for Medical Devices.



Symbol for manufacturer and date of production.



Device of type BF according to DIN EN 60601-1



Symbol for the connection of the external power supply unit (DC voltage 15-20V with indicated polarity)



USB-Interface



The symbol indicates that in accordance with the Directive 2002/96/EEC (Waste Electronic and Electrical Equipment Directive) and national laws, a product must not be disposed of in the household waste, and that within Europe it has to be disposed of in a special way.



Carefully read the accompanying documentation, particularly all information concerning product safety



This symbol indicates a potential hazard that can cause a loss of eyesight. This warning indicates the type of hazard and how it can be avoided.

REF

Item number of the measuring system / accessories

SN

Serial number of the measuring system

2 Application and safety

2.1 Intended Use

Main function of the force distribution measurement system FDM-T is the spatially resolved force distribution measurement under human feet for the analysis of static and dynamic strains as well as the individual gait parameters.

Operation as well as data evaluation and storage are software-aided by using a computer. The measuring systems are suitable for the use with patients that are mentally capable of following the operator's instructions without limitations in the period of application.

The patient's weight is limited by the maximum permissible weight of the treadmill. For the application of the FDM-T with children or patients with severe movement disorders, a fall stop safety is strongly recommended.

Professional facilities (medical practices, clinics, scientific institutions, rehabilitation centres, and orthopaedic specialist shops) are specified as application environment.

The application and operation of the system may only be carried out by thoroughly trained qualified personnel such as clinical doctors, physiotherapists, orthopaedic technicians which possess the ability to evaluate the output data in medical aspects as a aid for the diagnosis, treatment or patient care and taking into account the clinical history of the patient in the context of other diagnostic tests.

2.1.1 Indications

- Stance and gait analysis of the "normal" as well as the pathological stance and gait
- Diagnosis support with foot malpositions and foot corrections
- Diagnosis support and therapy of imbalances / incorrect gait pattern
- Detection of inappropriate mechanical stress and overstraining for the prevention of physical problems and for rehabilitation with disabilities after injury, accidents or surgeries.
- Support with the development, adjustment and verification of orthopaedic aids for the individual patient care
- Balance analysis and balance training
- Gait training in combination with dynamic visual stimulation (cueing) and feedback training as therapy/rehabilitation measures after a surgery, stroke, with the Parkinson's disease as well as other neurologic geriatric and orthopaedic disorders
- Success control of therapy/rehabilitation measures

2.1.2 Contraindications

- The FDM-T system must not be applied for a barefoot measurement with patients having open wounds and/or infections on the feet.
- Use for gait training with patients having the following contraindications only after approval through a medical specialist: pregnancy, heart and/or arterial diseases, artificial joints or prosthesis, fractures, damaged discs or traumatic disease of the spine.

2.2 Safety

2.2.1 Environmental conditions

FDM-T measuring systems are suitable for application in dry interiors with level ground such as those in hospitals, doctors' surgeries and laboratories.

Temperature range	10°C to 40°C
Relative humidity	30% to 70%



FDM-T systems must NOT be operated in wet zones, wet rooms (swimming pools, saunas) or climatic chambers.

Direct contact with liquids must always be avoided, as the measuring system is not protected against the entry of liquids. Liquids penetrating the device can cause fire, electrical shock or other severe accidents.

The FDM-T system is NOT specified for the operation in vacuum, hyperbaric or altitude chambers.

The measuring systems are not intended for operation in potentially explosive atmospheres of medically used rooms or oxygen-enriched atmospheres.

The devices must not be operated in proximity to e.g. engines or transformers with a high connected load as well as mains current lines, as electrical or magnetic interference fields can falsify correct measurements resp. turn them impossible. Therefore, the devices have to be protected against humidity. The ventilation slots of the treadmills must be free at all times, so that air can circulate freely.

2.2.2 Storage and Transport

Storage and transport of the measuring system are only to be effected in the original packaging provided by zebris.

Storage temperature	-20°C to +70°C
Relative humidity	5% to 90%
Air pressure	700 hPa to 1060 hPa



NOTE

All FDM-T systems can be stored without power supply for a maximum of 6 to 9 months. After this period, the battery may be totally discharged due to lacking power supply. If the storage of the device exceeds this period, a re-programming of the treadmill control may be necessary.

2.2.3 User Obligations



- The relevant, general guidelines and/or national laws, national regulations and technical rules for the commissioning and the operation of medical products must be applied and fulfilled corresponding to the indicated purpose of the zebris product. In Germany, operators, device in-charge persons and users are obliged to operate their devices in consideration of the MPG-regulations.
- Users are obliged to:
 - ✓ observe all safety guidelines of the user manual.
 - ✓ carry out any inspection and maintenance works on a regular basis as stipulated in the user manual.
 - ✓ only use work equipment that is free of defects.
 - ✓ check the functional safety and the proper condition of the device before operating.
 - ✓ make all user manuals that are included in delivery and part of the measuring system accessible to all users at all times and keep the manuals in close proximity of the measuring system.
 - ✓ protect him-/herself, the patient or third parties against dangers.
 - ✓ avoid a contamination through the product.
- When using the system, national legal regulations must be observed, in particular:
 - ✓ the valid industrial safety regulations.
 - ✓ the valid accident prevention measures.
- For the safety, reliability and performance of the components delivered by zebris, responsibility is assumed, if:
 - ✓ assembly, extensions, re-settings, changes or repairs were carried out through zebris or third parties authorised by zebris, trained technicians or employees of authorised dealers. Storage and transport are only to be effected in the original packaging delivered by the manufacturer.
 - ✓ the device is operated in accordance with the user manual.
 - ✓ in case of repair, the regulations of the VDE 0751-1 “Recurrent test and test before commissioning of medical electrical equipment – general regulations” are fully complied with.
 - ✓ the components of information technology provided by the operator correspond to the technical requirements of hard and software included in this user manual and also were installed and set up according to the relevant descriptions in this user manual.
 - ✓ the set-up room corresponds to the given environmental conditions of the measuring system and the valid installation regulations.
 - ✓ the FDM-T system including accessories is connected to the mains socket with a protective grounding conductor and is operated with the correct mains voltage.
 - ✓ exclusively the software provided by zebris as well as the components and accessory parts listed in this user manual are used together with the system.

2.2.4 General safety instructions



- The application and operation of the system and also the evaluation of the measuring data and their interpretation may only be carried out by trained qualified personnel. The manufacturer assumes no liability for any injury to persons, damage to property, or loss of data due to improper use of the software, the device or its component parts.
- The patients' data and measuring data may only be copied, moved, or deleted using the database function provided by the zebris application programs. In the case of data being changed intentionally without using the database functions, the user alone bears the full risks involved.
- Measurement and analysis results should always be interpreted in the light of the clinical history of the patient and in the context of other diagnostic tests by a trained person proven and tested for their relevance.
- Should any measures for treatment be taken on the basis of the measuring results, the measuring system may only be implemented as a supplementary means for evaluation by an expert. On no account can, or may invasive measures, or measures endangering the patient be carried out solely on the basis of the measuring results without further verification of the measuring data by additional methods.
- Should there be any detectable damage to the device or component parts, they should be returned to the manufacturer for a safety check. It is not permissible to continue using the device or its component parts, as severe damage and serious injuries – even lethal injuries - may result. The manufacturer or authorized sales partner must always be contacted in all cases of fault or doubt.
- If any fluids should penetrate the device, it is mandatory for the device to undergo a technical, safety test. Damaged plug connections and leads are to be replaced by an authorized service technician. The device must be put out of operation immediately, marked as "Not working" and prevented from being used by removing the mains cable. Please refer to an authorized technician immediately.
- The measuring system must be checked for a proper measuring function on a regular basis. Please find more detailed information in chapter 7 of this user manual.
- Be sure that all the mains and connection cables are laid safely and that they are protected against stepping on, so that nobody can trip over them. Check all the cables and the connection plug regularly for any damage. Damaged power supplies and cables have to be replaced before further operation.
- Never insert any objects in the components of the measuring system.
- A highly precise speedometer is integrated within the FDM-T System. This device contains a laser Class 2 ($\lambda=650\text{nm}$, $P>1\text{mW}$). It is strictly forbidden to remove all covers of the treadmill which are marked with the symbol shown left as long as the measuring platform is connected to mains supply (as long as the external power supply unit of the platform is plugged to mains supply). Caution: If other procedures than those described within this user manual are conducted, dangerous laser radiation can be released. Direct eye contact with the laser beam may lead to serious injuries of the eye.



2.2.5 Safety instructions for the Treadmill



- The treadmill belonging to the FDM-T measuring system is a very powerful device. For safe operation of the FDM-T system it is mandatory to adhere exactly to the safety regulations described in the following.
- The measuring procedure on the treadmill must never be commenced without a thorough instruction of the patient by trained personnel. No measurements may be taken without a supervisor.
- Do not place the treadmill on an unstable ground.
- Do not set up the system near a source of heating or in direct sunlight in front of a window as a strong rise in temperature can lead to inaccurate measuring results.
- Directly behind the treadmill it is mandatory for a safety zone of 2 m in length and 1 m in width to be kept free, and ought to be padded (with a soft mat). No items may be left in this zone during operation (such as video camera, lighting equipment etc.).
- Dangerous drawing-in gaps are located at the rear end of the running belt and along its sides and (if existing) on the elevating mechanism. Do not wear any loose clothing that could get caught up in the rollers. Make absolutely sure that if a person trips over, their long hair, loose clothing, jewellery, etc., do not come into contact with the rear part of the treadmill belt (e.g. wear a hair net). Due to danger of stumbling, do not place any clothing or jewellery on or within close proximity of the treadmill.
- Never use the treadmill without the safety clip being fastened to your clothing and always be sure that the folding mechanism (if existing) is properly locked during operation. (Please also be sure to read the safety instructions in the user manual supplied by the treadmill manufacturer.)
- During operation, the Emergency STOP facilities must always be within easy reach for the user and the operating personnel.
- The patient should walk slowly to begin with. Then gradually speed can be increased after a few minutes, depending on the patient's physical condition. Improper or excessive strain through tests resp. measurements can have harmful effects on health.
- Never jump onto the running belt and never jump off it whilst it is running. Never stop walking while the treadmill is running, never turn round or step sideward or backwards. Should movement patterns of this kind be necessary for your measurements, please make sure to use a type of treadmill with a safety arch, protection against falling and a "fall stop" chest belt.
- Pull out the power plug before transporting the treadmill.

2.2.6 Prohibited Use



- Improper and/or prohibited use of the measuring system is impermissible and zebris warn explicitly against all prohibitions included in this section.
- Do not try to service the treadmill in any manner other than that described in this user manual. By the removal of the protective covers it is possible that you could expose yourself to lethal high voltages or other hazards.
- We also point out that if any changes are made to this certified device or its accessories without the prior written consent of zebris, your legal right to operate the device will be void. If changes are made to the device without obtaining approval, the operator is obligated to carry out suitable investigations and tests in order to guarantee safe use.
- It is prohibited to embed the treadmill in the floor in order to reduce (track) access height. This way of installation might create a highly dangerous capture area at the rear guide pulley of the treadmill. The zebris Medical GmbH expressly will undertake no liability for injuries to any person when the treadmill is operated under such condition!
- All applications using wheels are prohibited (cycling, wheelchair, inline skating or roll ski) as well as running shoes with spikes or studs. Besides their extremely high risk of injury, these can cause irreparable damage to the sensors.
- There should never be more than one person on the treadmill at a time once it is in operation.
- Children and animals are not allowed to use the treadmill without supervision and must maintain a safety distance of at least 5 m.
- Any manner of over-exerting the test persons is strictly prohibited. In cases of nausea and dizziness, the measuring is to be discontinued immediately and a doctor consulted.
- Any form of operation involving an increased hazard is strictly prohibited, e.g. sprinting, or also using test persons having an increased risk.
- The use of the measuring system under the influence of alcohol, drugs or narcotics is strictly prohibited.
- zebris measuring systems may not be operated in any other environmental conditions than those listed in the section "Specifications", (e.g. in wet zones, moisture-prone areas, or in climatic, vacuum, hyperbaric or decompression chambers, etc.). Direct contact with liquids must always be avoided, as the measuring system is not protected against entering liquids. Liquids entering the device can cause fire, electric shock or other severe accidents.

3 Product description

3.1 System Components

In its basic configuration the measuring system consists of the following components:

- Treadmill with integrated sensor equipment for measuring the force distribution
- Safety clip for the emergency shutdown
- Mains cable for connecting the treadmill
- External power supply unit for the FDM-T force plate
- USB cable (Type A-B, 3 m long)
- zebris application software zebris FDM
- Windows-compatible computer or notebook
- Silicone oil for lubricating the belt
- Cable guard with screws
- User manual for FDM-T system, treadmill, zebris FDM software

3.2 Specifications FDM-T Sensor

The sensors of the different FDM-T systems only vary in size of the measuring area, the number of single sensors included in the sensor module and the supported sampling frequency. All other technical specifications are identical.

Interfaces	USB synchronization input/output video synchronization infrared synchronization (optional)
Connectors	interface box on the treadmill housing frame
Measuring principle	capacitive force measurement
Operating voltage	16-18V DC
Power consumption	maximum 60 W (depending on the type)
Power supply via external power supply unit	100 – 240 VAC / 50/60 Hz
Accuracy of the calibrated measuring range	(1 – 120 N/cm ²) ±5 % of maximum range
Mechanical cross talk	-25 dB
Pressure threshold	1 N/cm ²

3.3 Technical specifications FDM-T measuring systems

Depending on the treadmill type, zebris FDM-T measuring systems are available as “medical line” (M) for medical and “sports line” (S) for non-medical applications.

With the most system types, the FDM-T sensor is available in the resolutions 1.4 sensors/ cm² (3i) and 0.6 sensors/ cm² (2i).

Type

FDM-TLR-3



Treadmill

Maxxus T1

Speed	0.8 to 14 km/h in 0.1 km/h intervals
Running surface	123 x 44 cm
Engine Power	1.47 kW
Power Supply	230 V AC, 50 Hz
Protection class	I
Weight	75 kg
Dimensions (L x W x H)	160 x 80 x 127 cm / folded 35 x 80 x 160 cm
Track access height	19cm
Elevation	none
Max. user weight	110 kg
Colour	white, grey

Version

FDM-TLR-3-3i

REF-No.	01543133
---------	-----------------

Platform

REF-No.	01243056
Sensor Area / cm	94.8 x 40.6
Number of Sensors	112 x 48 / 5376
Resolution	1.4 sensors/ cm ²
Sampling Frequency	100 Hz
Infrared Interface	optional IR-Box

Type**FDM-TD****Treadmill****Daum electronic ergo run premium8**

Speed	0.2 to 24 km/h in 0.1 km/h intervals
Running surface	150 x 50 cm
Engine Power	2.2 kW
Power Supply	230 V AC, 50 Hz
Protection class	I
Weight	190 kg
Dimensions (L x W x H)	200 x 92 x 150 cm
Track access height	18 cm
Elevation	-2 % – 15% in 0.5% intervals
Max. user weight	150 kg
Colour	silver grey

Version**FDM-TDSL-3i****FDM-TDS-3i****FDM-TDS-2i**

REF-No.	01543111	01543110	01543219
---------	-----------------	-----------------	-----------------

Platform

REF-No.	01243047	01243049	01243249
Sensor Area / cm	94.8 x 40.6	108.4 x 47.4	111.8 x 49.5
Number of Sensors	112 x 48 / 5376	128 x 56 / 7168	88 x 39 / 3432
Resolution	1.4 sensors/ cm ²	1.4 sensors/ cm ²	0.6 sensors/ cm ²
Sampling Frequency	100 Hz	120 / 240 Hz	120 Hz
Infrared Interface	optional IR-Box	optional IR-Box	optional IR-Box

Type**FDM-THM****Treadmill****h/p/cosmos mercury / mercury med**

Speed	0 to 22 km/h in 0.1 km/h intervals
Running surface	150 x 50 cm
Engine Power	3.3 kW
Power Supply	230 V AC, 50 Hz
Protection class	I
Weight	220 kg
Dimensions (L x W x H)	210 x 80 x 137 cm
Track access height	18 cm
Elevation	0 – 25 % (-25 % to + 25 % with option of running direction reversal)
Max. user weight	200 kg
Colour	grey aluminium RAL 9007

Version**FDM-THM-S-3i****FDM-THM-S-2i****FDM-THM-M-3i****FDM-THM-M-2i**

REF-No.

01543115**01543215****01543125****01543425****Platform**

REF-No.

01243050

01243250

01243050

01243250

Sensor Area / cm

108.4 x 47.4

111.8 x 49.5

108.4 x 47.4

111.8 x 49.5

Number of Sensors

128 x 56 / 7168

88 x 39 / 3432

128 x 56 / 7168

88 x 39 / 3432

Resolution

1.4 sensors/ cm²0.6 sensors/ cm²1.4 sensors/ cm²0.6 sensors/ cm²

Sampling Frequency

120 / 240 Hz

120 Hz

120 / 240 Hz

120 Hz

Infrared Interface

optional IR-Box

optional IR-Box

optional IR-Box

optional IR-Box

Type**FDM-THL****Treadmill****h/p/cosmos locomotion med (mercury med Basis)**

Speed	0 to 10 km/h in 0.1 km/h intervals
Running surface	150 x 50 cm
Engine Power	3.3 kW
Power Supply	230 V AC, 50 Hz
Protection class	I
Weight	250 kg
Dimensions (L x W x H)	210 x 80 x 137 cm
Track access height	18 cm
Elevation	-15 % (-15 % to + 15 % with option of running direction reversal)
Max. user weight	200 kg
Colour	grey aluminium RAL 9007

Version**FDM-THL-M-3i****FDM-THL-M-2i**

REF-No.	01543160	01543260
---------	-----------------	-----------------

Platform

REF-No.	01243050	01243250
Sensor Area / cm	108.4 x 47.4	111.8 x 49.5
Number of Sensors	128 x 56 / 7168	88 x 39 / 3432
Resolution	1.4 sensors/ cm ²	0.6 sensors/ cm ²
Sampling Frequency	120 / 240 Hz	120 Hz
Infrared Interface	optional IR-Box	optional IR-Box

Type**FDM-THQ****Treadmill****h/p/cosmos quasar / quasar med**

Speed	0 to 25 km/h in 0.1 km/h intervals
Running surface	170 x 65 cm
Engine Power	3.3 kW
Power Supply	230 V AC, 50 Hz
Protection class	I
Weight	430 kg
Dimensions (L x W x H)	210 x 105 x 137 cm
Track access height	23 cm
Elevation	0 – 28 % (-28 % to + 28 % with option of running direction reversal)
Max. user weight	200 kg
Colour	grey aluminium RAL 9007

Version**FDM-THQ-S-3i****FDM-THQ-S-2i****FDM-THQ-M-3i****FDM-THQ-M-2i**

REF-No.

01543140**01543240****01543141****01543241****Platform**

REF-No.

01243052

01243252

01243052

01243252

Sensor Area / cm

135.5 x 54.1

132.1 x 55.9

135.5 x 54.1

132.1 x 55.9

Number of Sensors

64 x 160 / 10240

44 x 104 / 4576

64 x 160 / 10240

44 x 104 / 4576

Resolution

1.4 sensors/ cm²0.6 sensors/ cm²1.4 sensors/ cm²0.6 sensors/ cm²

Sampling Frequency

120 / 300 Hz

120 Hz

120 / 300 Hz

120 Hz

Infrared Interface

optional IR-Box

optional IR-Box

optional IR-Box

optional IR-Box

Type**FDM-THP****Treadmill****h/p/cosmos pulsar med**

Speed	0 to 40 km/h in 0.1 km/h intervals
Running surface	190 x 65 cm
Engine Power	3.3 kW
Power Supply	230 V AC, 50 Hz
Protection class	I
Weight	460 kg
Dimensions (L x W x H)	250 x 105 x 140 cm
Track access height	23 cm
Elevation	-25 % to + 25 %
Max. user weight	200 kg
Colour	grey aluminium RAL 9007

Version**FDM-THP-M-3i****FDM-THP-M-2i**

REF-No.	01543150	01543250
---------	-----------------	-----------------

Platform

REF-No.	01243059	01243253
Sensor Area / cm	155 x 54.1	155 x 54.1
Number of Sensors	192 x 64 / 12288	128 x 44 / 5632
Resolution	1,4 sensors/ cm ²	0,6 sensors/ cm ²
Sampling Frequency	100 / 200 / 300 Hz	100 / 200 / 300 Hz
Infrared Interface	optional IR-Box	optional IR-Box

Type**FDM-TF****Treadmill****ForceLink C-Mill 1.6****ForceLink C-Mill 1.8**

Speed	0.1 - 12 km/h in 0.1 km/h intervals	0.1 - 12 km/h in 0.1 km/h intervals
Running surface	158 x 60 cm	178 x 70 cm
Engine Power	1.8 kW	1.8 kW
Power Supply	230 V AC, 50/60 Hz	230 V AC, 50/60 Hz
Protection class	I	I
Weight	200 kg	250 kg
Dimensions (L x W x H)	210 x 90 x 13 cm	250 x 105 x 140 cm
Track access height	18 cm	18 cm
Elevation	0 – 15 % (optional)	0 – 15 % (optional)
Max. user weight	135 kg	135 kg
Colour	grey	grey

Version**FDM-TF1.6-3i****FDM-TF1.6-2i****FDM-TF1.8-3i****FDM-TF1.8-2i**

REF-No.	01543171	01543271	01543170	01543270
---------	-----------------	-----------------	-----------------	-----------------

Platform

REF-No.	01243071	01243271	01243070	01243270
Sensor Area / cm	108.4 x 47.4	111.8 x 49.5	135.5 x 54.1	132.1 x 55.9
Number of Sensors	7168	3432	10240	4576
Resolution	1.4 sensors/ cm ²	0.6 sensors/ cm ²	1.4 sensors/ cm ²	0.6 Sensors /cm ²
Sampling Frequency	120 Hz	100 Hz	120 Hz	100 Hz
Infrared Interface	optional IR-Box	optional IR-Box	optional IR-Box	optional IR-Box

3.4 Measuring Principle FDM-T Systems

The system contains a measuring matrix consisting of capacitive force sensors that are arranged in columns and lines running closely next to each other. For determining the force distribution over the measuring matrix the capacity proportional to the force exerted is determined for each individual sensor. To do this, the drive logic generates a number of sinus burst signals equivalent to the number of columns via the column decoder, and transmits them to the respective measuring column. The analogue signal coupled into the shift register over the lines is proportional to the pressure-dependent capacity and is passed on for further processing to the control and signal-processing electronics and transmitted to the PC from there and shown on the display.

Schematic circuit diagram of the measuring system

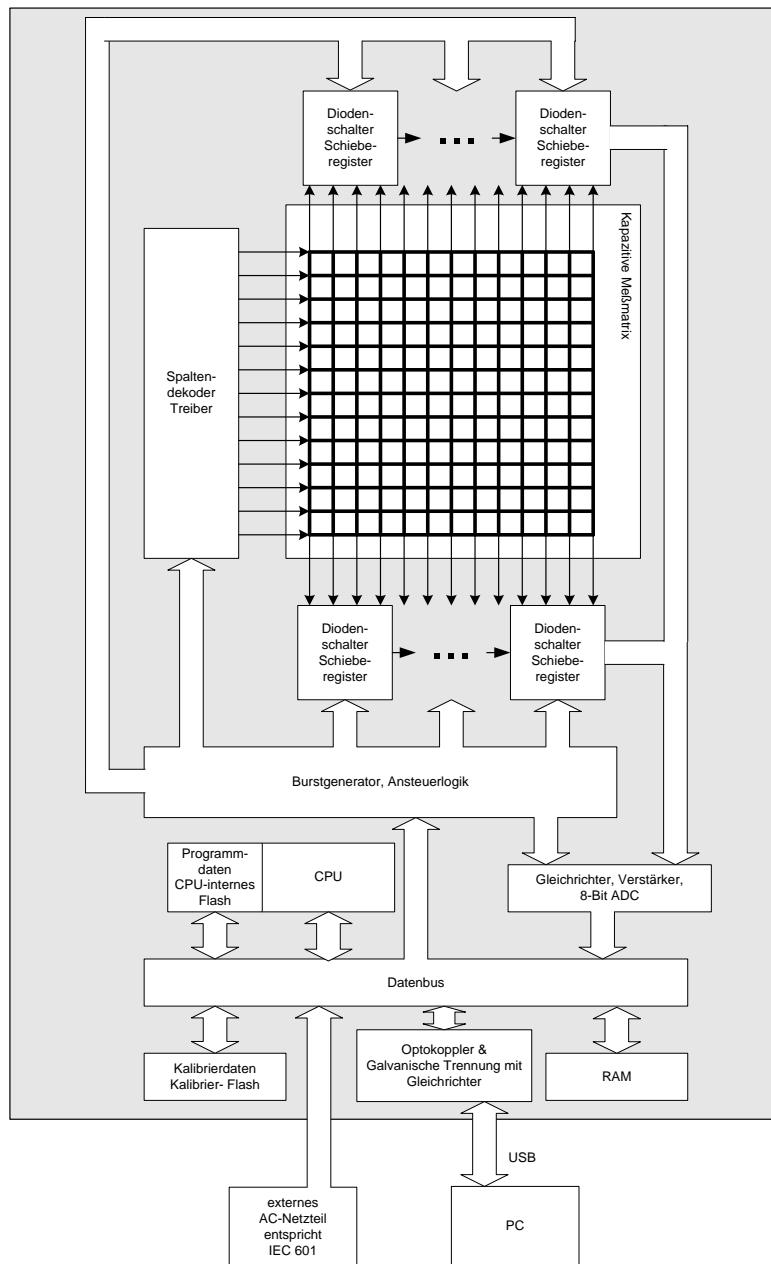

3.5 Controls and Connectors

All the cable connections are carried out via the interface box which is located on the underneath of the treadmill frame on the back.

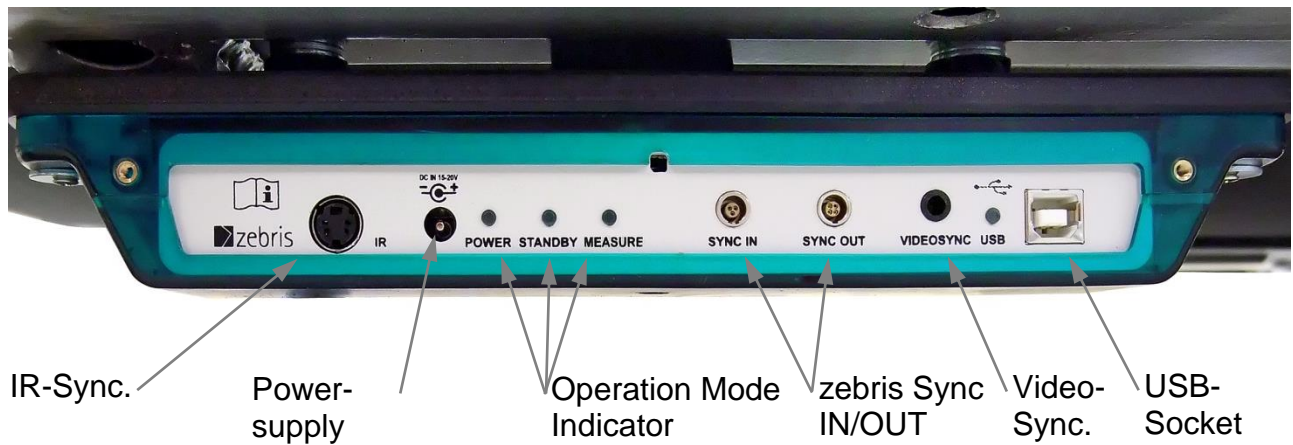

3.6 LED indicator lights of the interface box

POWER lights up as soon as the power supply unit is plugged to the interface box and connected to mains.

STANDBY lights up if the power supply unit is connected to mains, the USB socket is connected to the PC and the hardware driver of the platform is installed properly.

MEASURE lights up during the measurement.

USB lights up when the USB socket is connected to the PC and the hardware driver of the platform is installed properly.

3.7 zebris SYNC

The **zebris SYNC** is the standard solution for synchronization of the FDM-T system with third party measuring devices.

The **SYNC-IN** and **SYNC-OUT** sockets provide input and output for support of „sample by sample“ In- and Out synchronization. Both sockets provide galvanic protection between third party systems and FDM-T sensor.

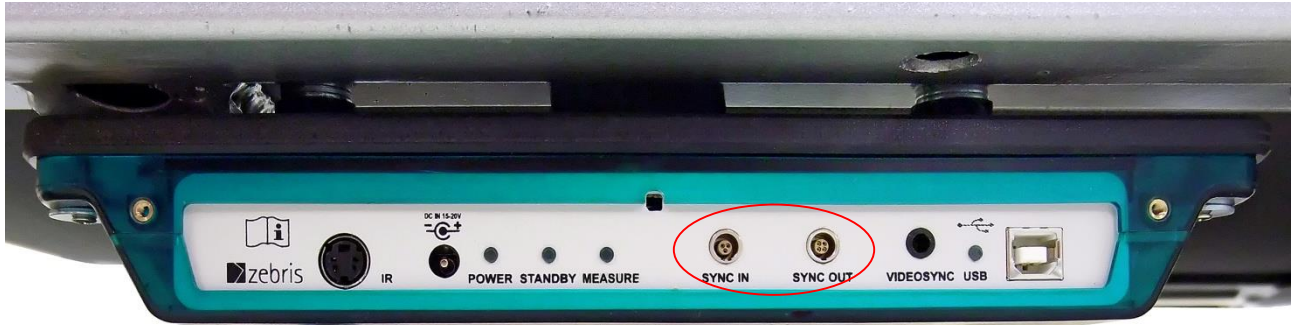

WARNING

Patient's safety is guaranteed by means of galvanic separation according to the provisions of IEC 601-1 when a third party device is synchronized with the FDM-T system. This allows non-medical equipment to be synchronized with the FDM-T system as long as such devices are out of patients reach. Nevertheless the user is completely responsible for the safety of all third party devices used in combination with the FDM-T system.

The correct synchronisation of all measurement data has to be verified in case devices are connected to zebris SYNC which have not been manufactured by zebris Medical GmbH.

zebris does not accept any liability for correct function and reliability of the system if the clock signal of external devices does not comply with the signal specifications provided with in this user manual.

3.7.1 Synchronization Input (SYNC-IN)

If a third party device is connected to the synchronization input SYNC-IN then depending on the setting of the configuration window from the application software the measurement will start/stop or “sample by sample” synchronized by a signal from the third party device.

Input is protected against faulty polarisation and pin 1 is set to +5V ("1") by an internal pull-up-resistor (2.7 kΩ). If this input is set to 0 V ("0") i.e. by a switch or break contact than the SYNC-IN is triggered.

Electrical Specifications

Input Resistance (Pull-Up 5V)	2.7 kΩ
V _{IH} (High-Level Input Voltage)	≥ 2.0 V
V _{IL} (Low-Level Input Voltage)	≤ 0.8 V
Required min. pulse time for triggering	1ms

Integrated LEMO socket in the interspace box

Series "00", three pole, coding 30°

LEMO-Part-No.: EPA.00.303.NLN



View
Socket, Front Side

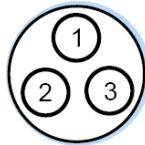

Socket Coding: 30°



Suitable Plug for SYNC-IN:

LEMO-Part-No.: FGA.00 303.CLADxxxx

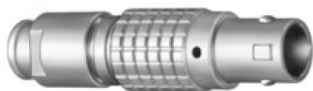

View
Plug, Solder Side



Plug Coding: 30°



Pin Assignment

Pin 1	Clk_IN
Pin 2	Activ_IN
Pin 3	GND

3.7.2 Synchronization Output (SYNC-OUT)

If a third party device is connected to the synchronization output SYNC-OUT then depending on the setting of the configuration window of the application software, a FDM-T system controlled, will trigger a synchronized measurement of the third party device either via start/ stop or "sample by sample" mode.

Electrical Specifications

Output Resistance	100 Ω
V _{OH} (High-Level Output Voltage)	≥ 2.0 V
V _{OL} (Low-Level Output Voltage)	≤ 0.8 V

Integrated LEMO socket in the interspace box

Series "00", four pole, Coding 0°

LEMO-Part-No.: EPG.00.304.NLN



View
Socket, Front Side

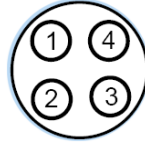

Socket Coding: 0°



Suitable Plug for SYNC-OUT

LEMO-Part-No.: FGG.00 304.CLADxxxx

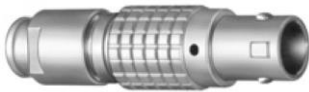

View
Plug, Solder Side



Plug Coding: 0°



Pin-Assignment

Pin 1	+5V
Pin 2	GND
Pin 3	Activ_OUT
Pin 4	Clk_OUT

3.7.3 IR-Synchronization Box for DAB-Bluetooth (zebris EMG)

For synchronizing the FDM-T system with the zebris DAB-Bluetooth the optionally available **IR synchronization box** is required.

REF-No. 183.2021 / IRS-E Infrared Sync, cable length 1 m



The IR synchronization box is connected to the system in the **IR socket** of the interface box and then fixed simply and safely to the treadmill frame using the integrated magnet.





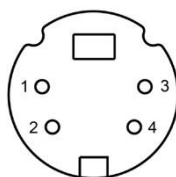

FDM-T platform and DAB-Bluetooth are synchronized automatically as soon as both devices have been switched on and a measurement is started.

Pin Assignment IR-Box

- Pin 1 not used
- Pin 2 + IR
- Pin 3 GND
- Pin 4 - IR



3.8 Spare Parts FDM-T System

REF-No.	Description	Illustrations
01832035	FDM-T Interface Box2 incl. fixation screws	
11511021	Cable protection cover for mounting on the interface box incl. fixation screws	
33102024	PS Mascot 2420 Power supply unit 60W/16VDC for FDM-T sensors equiv. to EN 60601-1 & UL	
07200010	zebris FDM Software for operating system Windows 7 32/64 Bit	
21030071	USB cable A-B, 3 m long Data connection between interface box and PC	
79010095	Hardware FDM-T user manual / english Printing version is liable to be charged. Free download of PDF-Files from zebris Service Center:	
79010185	Software zebris FDM user manual / english Printing version is liable to be charged. Free download of PDF-Files from zebris Service Center:	

3.9 Accessories FDM-T Measuring System

REF-No.	Description	Illustrations
01540191	SYNCCam Camera with USB-Cable, synchronization cable, tripod, inclusive software extension	

01540194

SYNCLightCam

Combined solution with Camera and illumination, USB-Cable, synchronization cable, tripod, inclusive software extension



21030321

SYNCCam USB-Cable A-B

USB-Cable for HD-video signal with high quality plugs, EMC-shielding and ferrites length 5 m



01830016

Video Sync-Control Cable 7.0

Length 7 m, both sides phone jack 3.5 mm with amplifier and control-LED for DV-camcorder



21030315

Video Sync-Control Cable 0.9

Length 0.9m, both sides phone jack 3.5 mm for direct connection of the SYNCLight to the zebris SYNCCam



01830041

Video Sync-Control Cable 2.5

Length 2.5 m, both sides phone jack 3.5 mm, without amplifier for zebris SYNCCam



21030312

Video Sync-Control Extension Cable

Length 5 m, phone jack & socket 3.5 mm



01540110

SYNCLight

with 10 power LEDs, power supply unit, light intensity infinitely variable VIDEOSYNC, without tripod



01831105

SYNCLight Power Supply Unit

Mains adapter 40W / 24V DC



01540110

SYNCLight Plus

with 10 power LEDs, power supply unit, light intensity infinitely variable VIDEO SYNC, PULSE SYNC, zebris SYNC



up to 3 SYNCLight Plus can be combined into a lighting unit, without tripod.

33102210 **SYNCLight plus Power Supply Unit**

Mains adapter 110W / 24V DC,
Supports up to 3 SYNC Light plus.



01850011 **SYNCLight plus Adapter Cable**

for Master-Slave connection
of up to 3 SYNCLight plus, length 1 m



01832021 **IRS-E Infrared Sync**

Cable length 1 m for synchronization
with zebris DAB-Bluetooth (EMG)



01551000 **Gait Training Type M**

Module for gait training through visual cueing
on h/p/cosmos mercury.
Contains video projector with clamp and
software extension for zebris FDM.



01551001 **Gait Training Type Q**

Module for gait training through visual cueing
on h/p/cosmos quasar.
Contains video projector with clamp and
software extension for zebris FDM.



01551002 **Gait Training Type L**

Module for gait training through visual cueing
on h/p/cosmos locomotion.
Contains video projector with clamp and
software extension for zebris FDM.



01551003 **Gait Training Type D**

Module for gait training through visual cueing
on h/p/cosmos ergo_run.
Contains video projector with clamp and
software extension for zebris FDM.

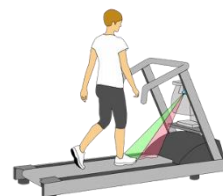

1551006 **Gait Training Type P**

Module for gait training through visual cueing
on h/p/cosmos pulsar.
Contains video projector with clamp and
software extension for zebris FDM.



4 Video-Module

4.1 Connection to the FDM-T System

The FDM-T system can capture data simultaneously with up to 2 video cameras. For this purpose the **zebris SYNC**Cam is available as an accessory. Alternatively high-quality DV-camcorders with an external microphone socket can be used for video capture.

In order to capture video data synchronized with force data the camera has to be connected to the galvanically isolated **VIDEOSYNC socket** on the interface box.



4.1.1 Connection to the zebris SYNC

The zebris **SYNC**Cam uses its integrated synchronization flash to synchronize video data with force data.

For connecting the SYNC

REF-No. 1801830041 Video Sync-Control Cable 2.5
Length 2.5 m, without amplifier



4.1.2 Connection to DV- camcorders with input for external microphone

The synchronization is effected by imprinting a clock signal on the soundtrack of the video recording. This data is evaluated automatically by the application software zebris FDM for synchronizing the platform data and the video signal.

For the connection to the DV- camera the following synchronization cable is required:

REF-No. 01830016 / Video Sync-Control Cable
Length 7 m, with amplifier and control-LED



4.1.3 Connection scheme SYNCLightCam

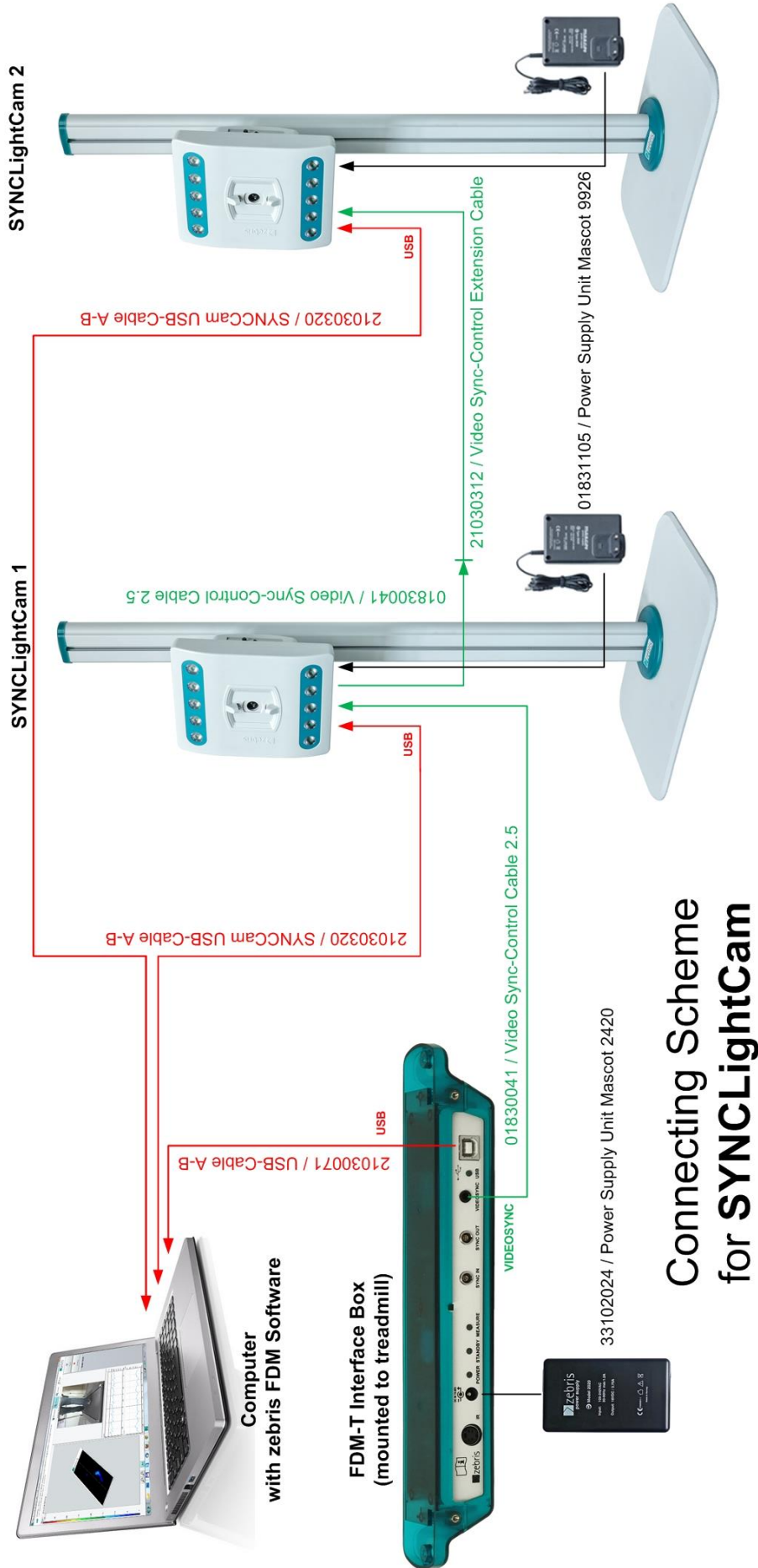

Connecting Scheme for SYNCLightCam

4.1.4 Connection scheme SYNCCam und SYNCLight

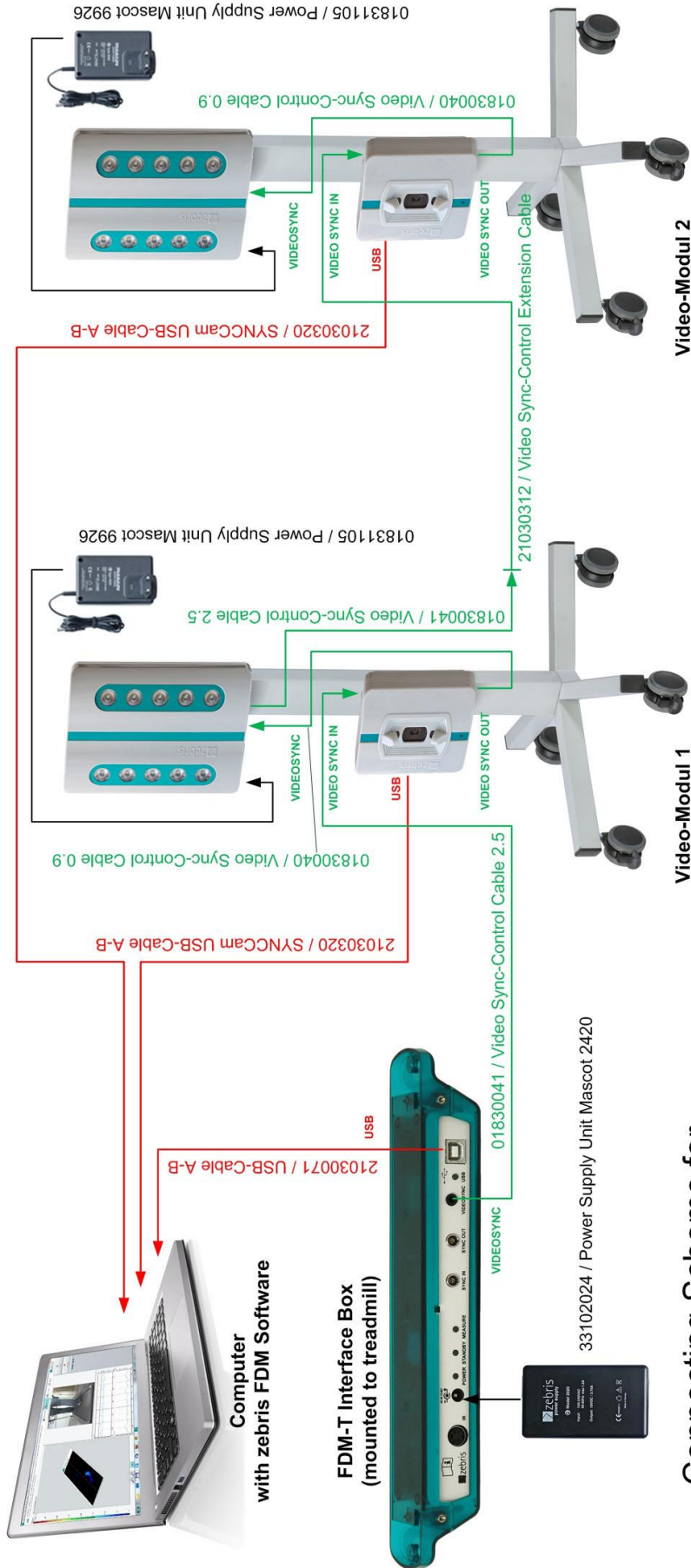

Connecting Scheme for
SYNCCam and **SYNCLight**
 controlled by **VIDEOSYNC**



The **VIDEOSYNC** sockets of the **SYNCLights** do not support a designated direction for IN and OUT of the synchronization signal. Therefore it does not matter which socket is selected for the connection of SYNCLight and interfacebox.

4.1.5 Connection scheme SYNCCam und SYNCLight plus

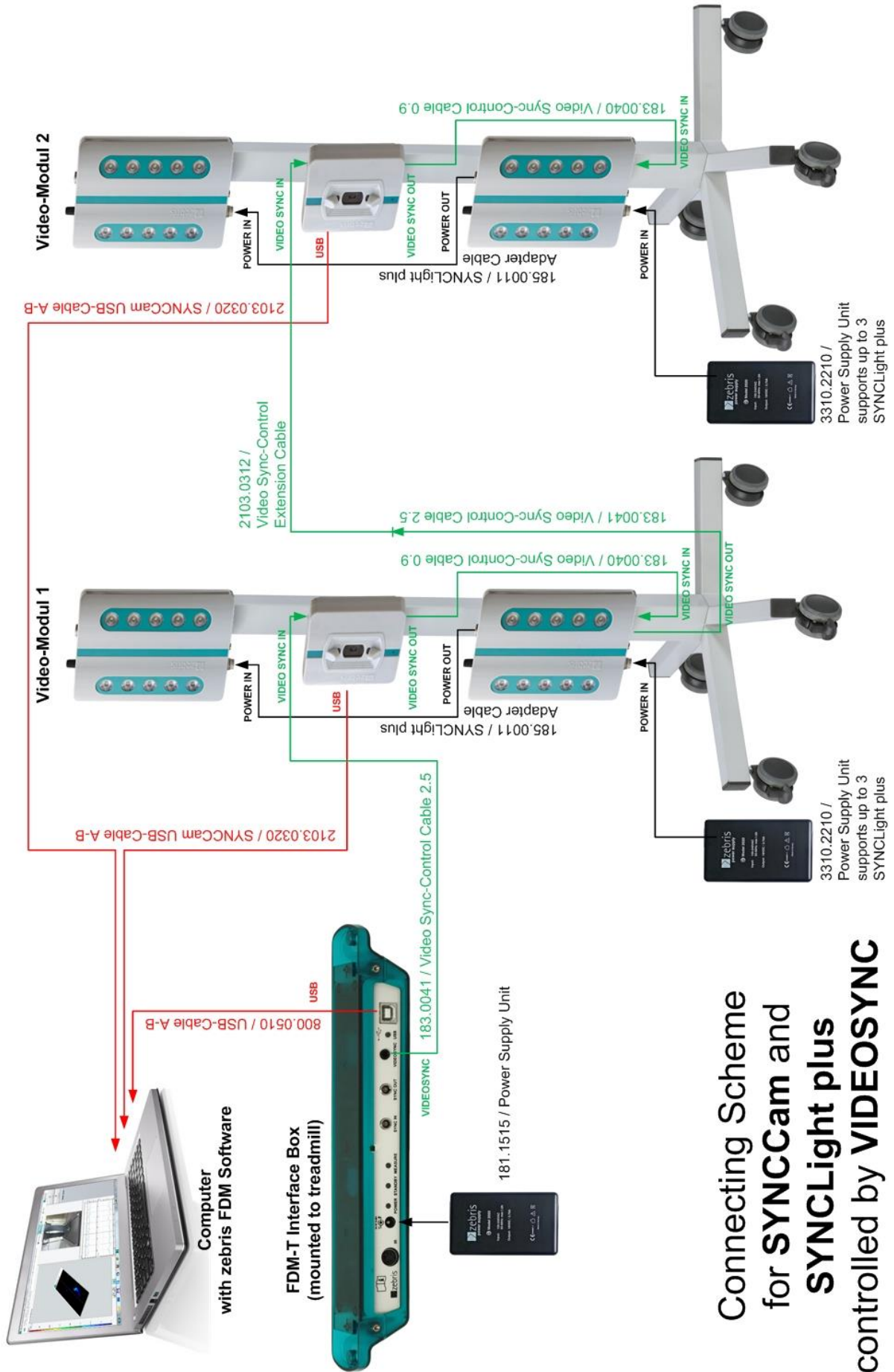

Connecting Scheme
for SYNCCam and
SYNCLight plus
controlled by VIDEOSYNC

4.2 SYNCCam

The **SYNCCam** is an accessory of the FDM-T system and perfectly adapted to be used in combination with the force distribution measurement. All adjustments of the camera are carried out via hardware setup integrated to the zebris FDM Software. The camera is connected to the PC by a USB cable of type A-B included within the shipment.

The camera is equipped with ¼ inch tripod threads and can be adapted to zebris tripods as well as commercially available camera tripods.



WARNING

The Sync-LEDs are flashing when the camera is disconnected from the USB port. Therefore it is strongly advised not to look directly into the camera when it is disconnected in order to avoid dazzling.

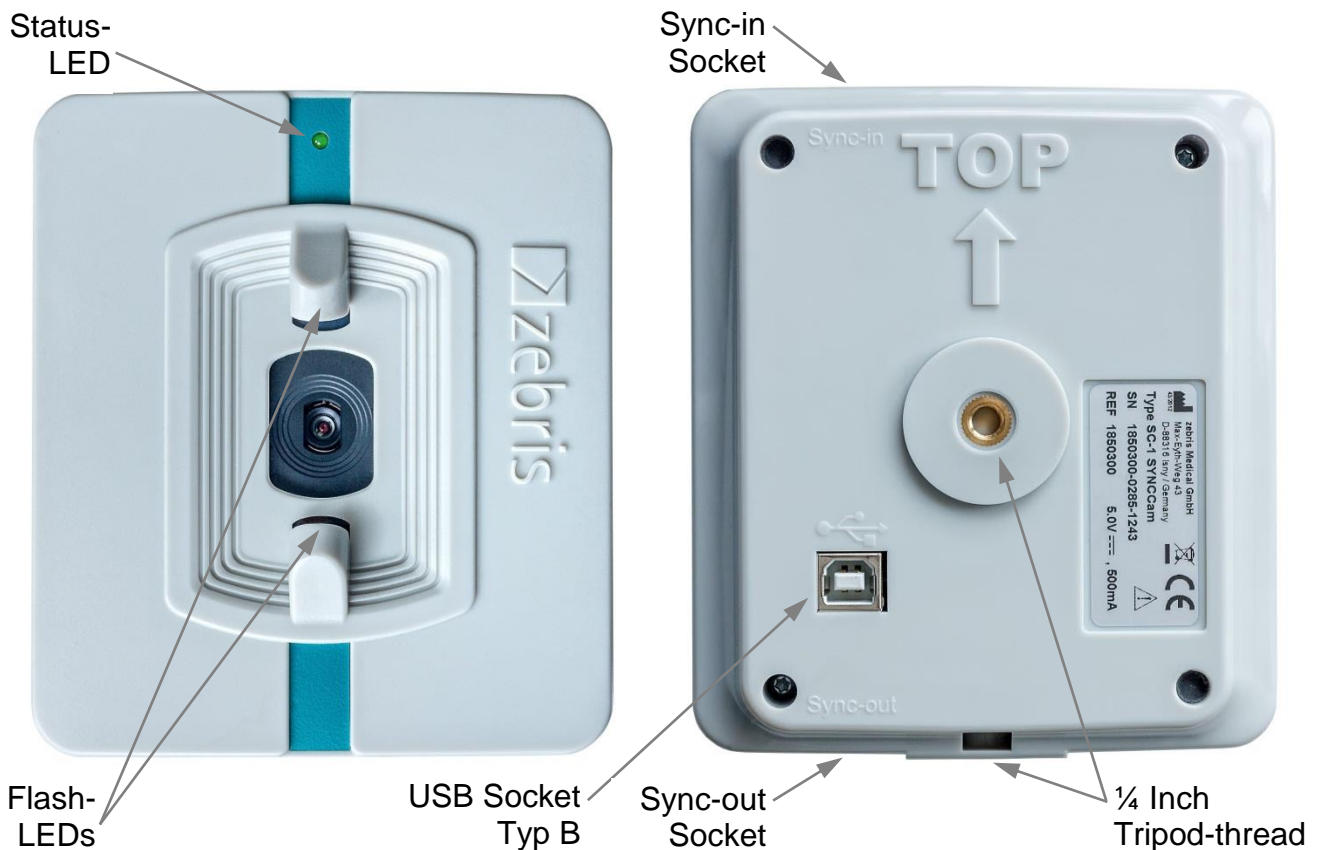

Technical Specifications

REF-No.	01540190
Dimensions	110 x 125 x 15 mm (L x W x H)
Weight	approx. 190 g
Power Supply	USB (5 V DC / 500 mA)
Resolution	1920 x 1080 Pixel (Full-HD) / Autofocus
Frame Rate	30 Hz
Synchronization	LED-Flash triggered by Sync-IN socket
Mounting	¼ Inch tripod-thread at bottom and back side



NOTE

In order to maintain undisturbed transmission of the video signal it is mandatory to use high quality USB cables.

Please, only use cables supplied or recommended by zebris for connecting SYNCCam and PC.

4.3 SYNCLightCam

The **SYNCLightCam** is an accessory of the FDM-T system and perfectly adapted to be used in combination with the force distribution measurement. All adjustments of the camera are carried out via hardware setup integrated to the zebris FDM Software. The camera is connected to the PC by a USB cable of type A-B included within the shipment.

The **SYNCLightCam** is equipped with ¼ inch tripod threads and can be adapted to zebris tripods as well as commercially available camera tripods.



The Sync-LEDs are flashing when the camera is disconnected from the USB port. Therefore it is strongly advised not to look directly into the camera when it is disconnected in order to avoid dazzling.

Furthermore contains the SYNCLightCam as an integral solution, the LED video illumination. In order to produce well lighted and tack sharp video captures it is essential to maintain perfect lighting conditions at the patient's side. Only with adequate lighting conditions video cameras can work with shutter times short enough to freeze fast movements and capture sharp images.

This solution is perfectly matched on the interaction with the FDM-T system and can be regulated infinitely in its brightness.

The integrated synchronization unit automatically switches the lights on at the start of a measurement and turns them off again after stopping it.

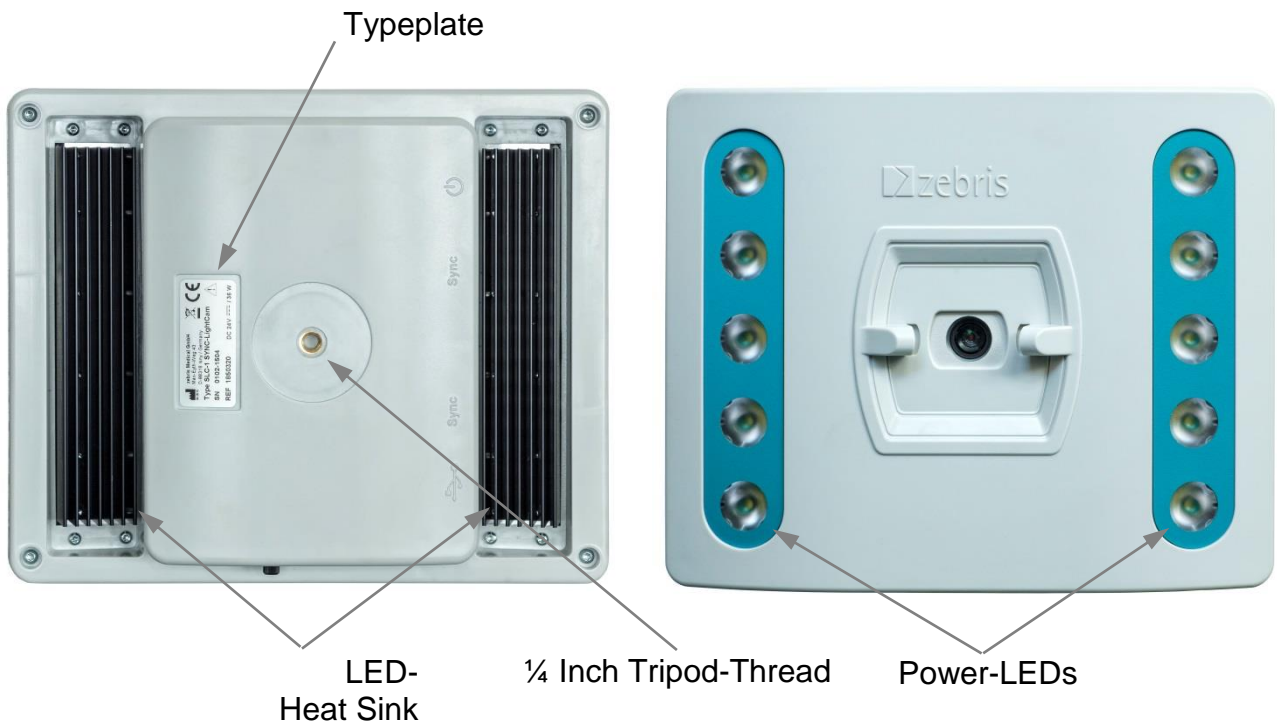

In order to ensure failure-free operation of the SYNCLights it is mandatory to keep the black heat sinks at their back side uncovered and well air circulated at all times.

Technical Specifications

REF-No.	01540194
Dimensions	220 x 183 x 80mm (B x H x T)
Weight	ca. 790g
Power Supply	24V / 36W
Resolution	1920 x 1080 Pixel (Full-HD) / Autofokus
Frame Rate	30Hz
Light Colour / Light Synchronization	Current 6200 K / 1550 Lumen VIDEOSYNC (Ein-/Aus schalten mit der Messung) SYNC IN Standard zebris Synchronisation (kompatibel mit SYNC IN/OUT Plattform)
Mounting	¼ Zoll Stativgewinde an der Rückseite

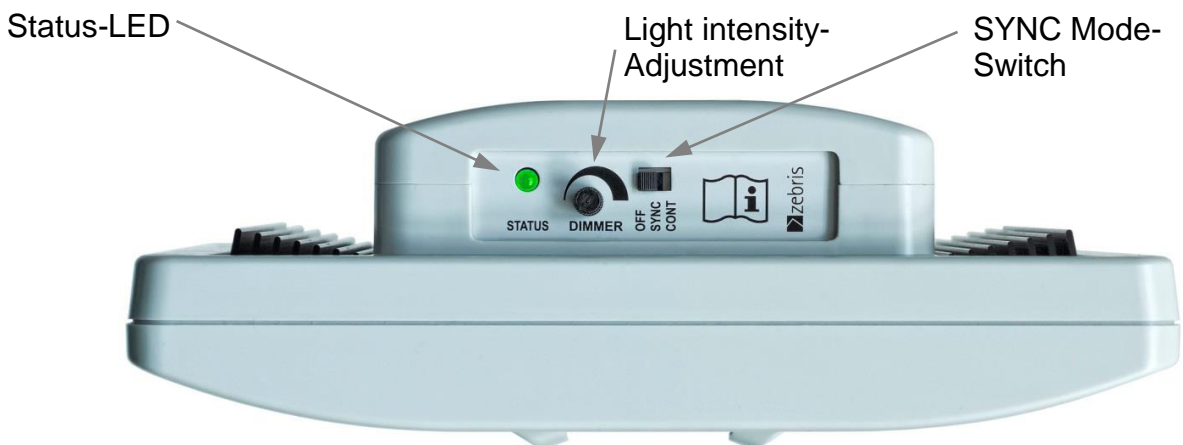

NOTE

In order to maintain undisturbed transmission of the video signal it is mandatory to use high quality USB cables.

Please, only use cables supplied or recommended by zebris for connecting SYNC Cam and PC.

Interpretation of the STATUS-LED

- Green** Device is ready for use or in operation.
- Orange** The orange colour indicates when the maximum operation temperature has been reached. At this point the operation current is reduced automatically (which results in reduced brightness) in order to prevent the SYNCLight plus from being damaged by excessive heat.

Power Supply Unit

For operation of the SYNCLight plus a power supply unit needs to be connected.

REF-No. 33102220

Input	Output	Cable	Length
100 – 240 V AC	24 V DC	DC-Lead	1.7 m
50 – 60 Hz	40 W	Mains Lead	Plug Adapter

SYNC-Modus

Modes **Characteristics**

**VIDEO
SYNC IN**

ESD - protected, voltage reversal proof input

Input resistance: 38 k Ω (AC)

Signal-Level: AC

Trigger Level: 15 mV

Pin Assignment

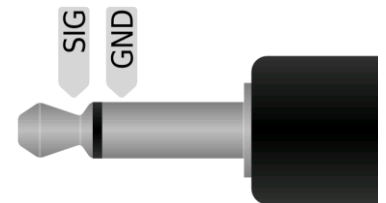

4.4 LED Video Lights (SYNCLight / SYNCLight plus)

In order to produce well lighted and tack sharp video captures it is essential to maintain perfect lighting conditions at the patient's side. Only with adequate lighting conditions video cameras can work with shutter times short enough to freeze fast movements and capture sharp images.

The LED video lights **SYNCLight** and **SYNCLight plus** are accessories of the FDM-T systems and perfectly adapted for use in combination with zebris **SYNCCam** as well as the force distribution measurement. Their brightness can be adjusted infinitely.

The integrated synchronization unit automatically switches the lights on at the start of a measurement and turns them off again after stopping it.

Both SYNCLights are equipped with ¼ inch tripod threads and can be adapted to zebris tripods as well as commercially available camera tripods.

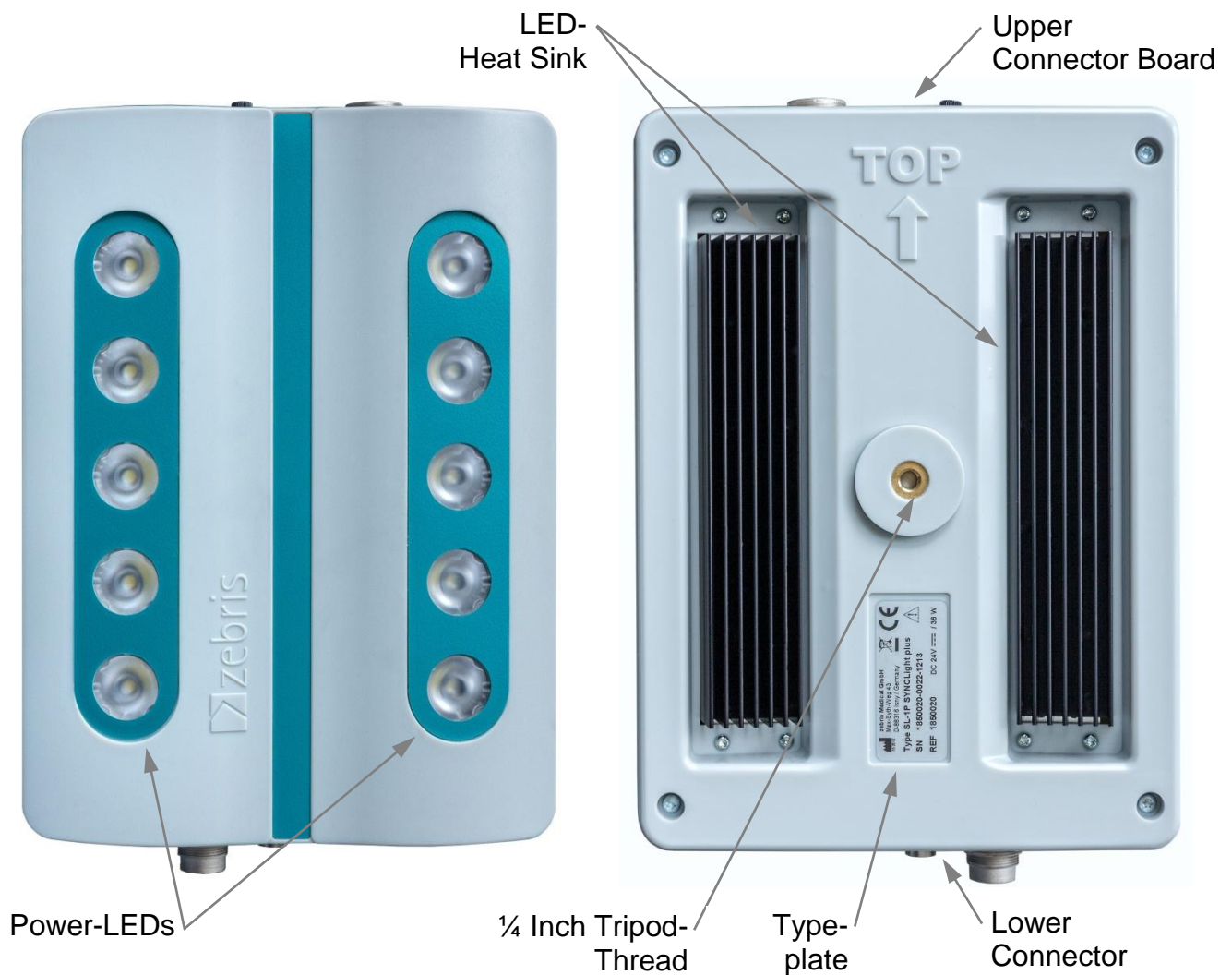

NOTE

In order to ensure failure-free operation of the SYNCLights it is mandatory to keep the black heat sinks at their back side uncovered and well air circulated at all times.

4.4.1 SYNCLight

If the synchronization signal from the interface box of the FDM-T system is connected to the **VIDEOSYNC** socket the SYNCLight will be automatically turned on and off when a measurement is started or stopped.

In order to use the synchronization set the **SYNC-Mode switch** to position SYNC. At position **CONT** the SYNCLight plus is switched on permanently. The **DIMMER** can be used to adjust the light intensity individually no matter which operation mode is set.

Technical Specifications

REF-No.	01540110
Dimensions / Weight	155 x 210 x 38 mm (L x W x H) / approx. 640 g
Power Supply	24 V DC / 36 W
Light Colour / Light Current	6200 K / 1550 Lumen
Synchronization	VIDEOSYNC (On-/Off with force measurement)
Mounting	¼ Inch tripod thread at back side

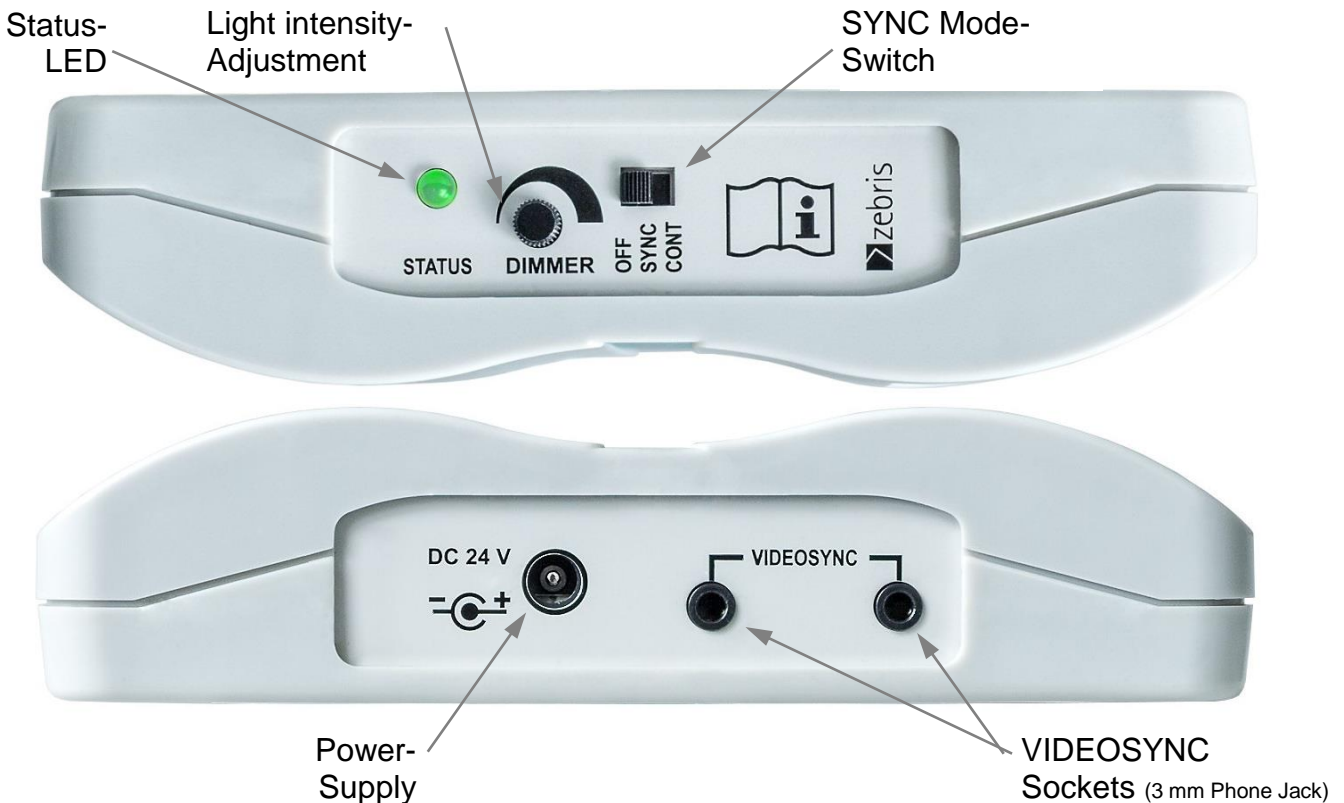

Interpretation of the STATUS-LED

- Green** Device is ready for use or in operation.
- Orange** The orange colour indicates when the maximum operation temperature has been reached. At this point the operation current is reduced automatically (which results in reduced brightness) in order to prevent the SYNCLight plus from being damaged by excessive heat.

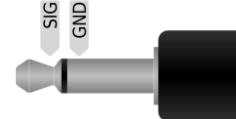

Power Supply Unit

For operation of the SYNCLight a power supply unit needs to be connected.

REF-No. 33102220

Input	Output	Cable	Length
100 – 240 V AC	24 V DC	DC-Lead	1.7 m
50 – 60 Hz	40 W	Mains Lead	Plug Adapter

4.4.2 SYNCLight plus

The SYNCLight plus supports the zebris VIDEOSYNC as well as more complex synchronization modes that may be required for use of industrial cameras.

In order to use the synchronization modes set the **SYNC-Mode switch** to position SYNC. At position **CONT** the SYNCLight plus is switched on permanently. The **DIMMER** can be used to adjust the light intensity individually no matter which operation mode is set.

Up to 3 SYNCLights plus can be combined to one lighting unit. For this purpose they have to be connected with an adapter cable. The adapter cable provides power supply as well as transmission for the synchronization signals.

Technical Specifications

REF-No.	01540120
Dimensions / Weight	155 x 210 x 38 mm (L x W x H) / approx. 640 g
Power Supply	24 V DC / 36W
Light Colour / Light Current	6200 K / 1550 Lumen
Synchronization	VIDEO SYNC → On-/Off with force measurement PULSE SYNC → Shutter Sync. with industrial cameras SYNC IN → Standard zebris synchronization (Compatible with SYNC IN/OUT platform)
Mounting	¼ Inch tripod thread at back side
Master – Slave Operation	off max. 3 SYNCLights plus by adapter cable 185.0011/SL-

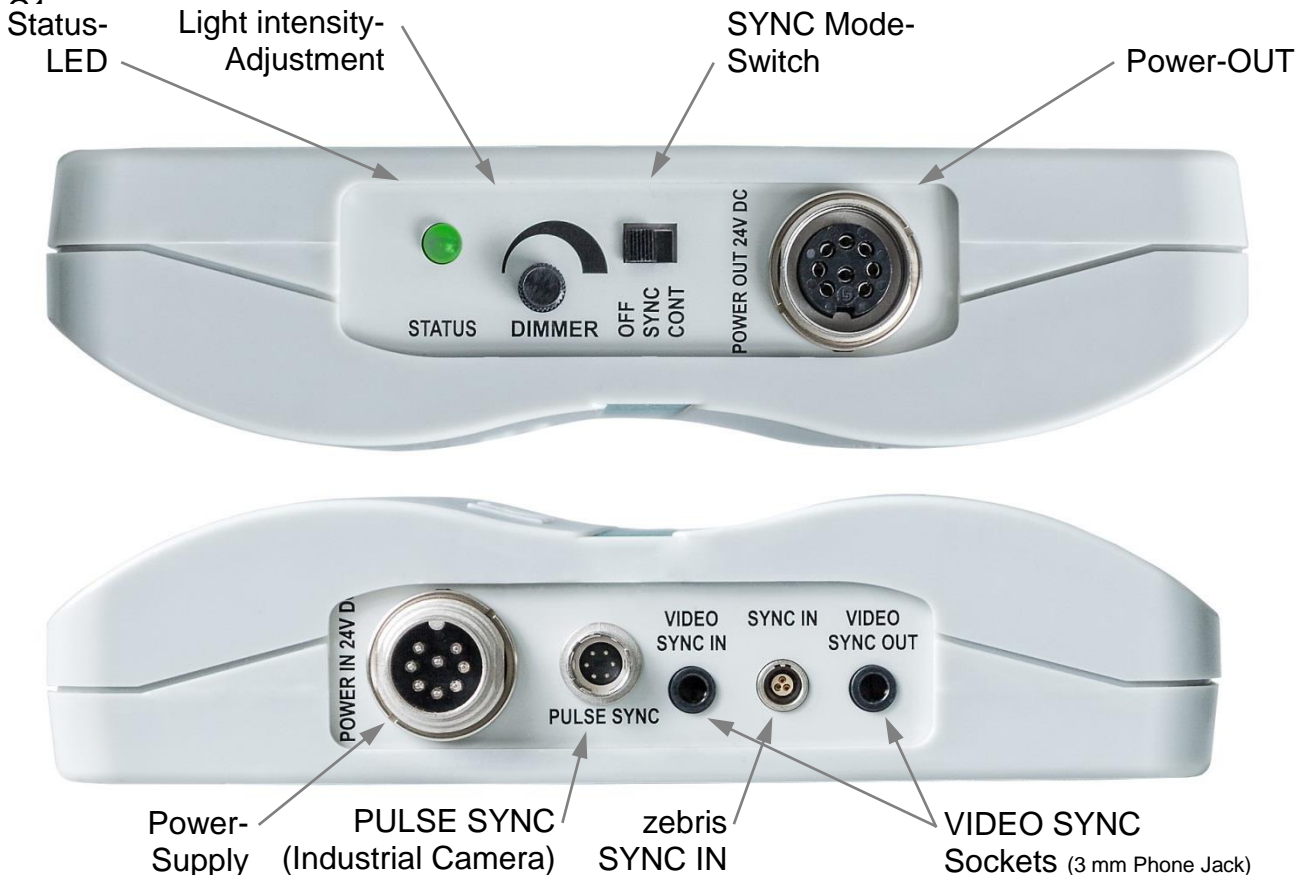

Interpretation of the STATUS-LED

- Green** Device is ready for use or in operation.
- Orange** The orange colour indicates when the maximum operation temperature has been reached. At this point the operation current is reduced automatically

(which results in reduced brightness) in order to prevent the SYNCLight plus from being damaged by excessive heat.

Power Supply Unit

For operation of the SYNCLight plus a power supply unit needs to be connected.

REF-No. 33102210

Input	Output	Cable	Length
100 – 240 V AC	24 V DC	Mains Lead	1.7 m
50 – 60 Hz	110 W	DC-Lead	1.7 m

SYNC-Modes

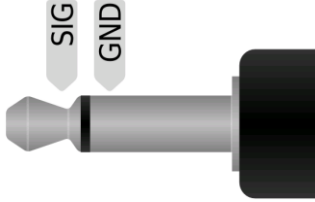
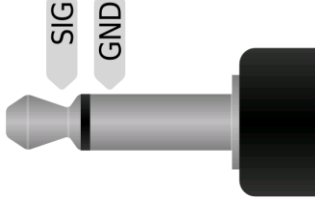
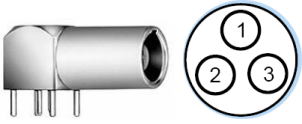
Modes	Characteristics	Pin Assignment
VIDEO SYNC IN	ESD - protected, voltage reversal proof input Input resistance: 38 k Ω (AC) Signal-Level: AC Trigger Level: 15 mV	
VIDEO SYNC OUT	ESD - protected, voltage reversal proof input The signal of the VIDEO SYNC IN is directly transmitted to VIDEO SYNC OUT and can be used for control of additional devices.	
SYNC IN	ESD - protected, voltage reversal proof input Input resistance: 38 k Ω (Pull-Up) V_{IH} (High-Level Input Voltage): ≥ 3.7 V V_{IL} (Low-Level Input Voltage): ≤ 3.0 V Both signals can be used as trigger input (“AKTIV” as well as “CLK”) and have the same effect. The signal switches the LED light on to the brightness level pre-selected by the DIMMER. The SYNC IN is the standard synchronization tool (zebris SYNC) of all zebris measuring systems and intended to be used to synchronize the lighting system with the measuring signal of other zebris measuring systems (e.g. CMS). In order to use SYNC IN the SYNC mode switch has to be set to position SYNC .	 3-Pin Socket Pin1: CLK Pin2: AKTIV Pin3: GND Socket Type LEMO- Part No. FGA.00 303.CLADxxxx

Modes Characteristics

PULSE SYNC

ESD - protected, voltage reversal proof input
 Input resistance: 2 kΩ (Pull-Up)
 VIH (High-Level Input Voltage): 2.0 V
 VIL (Low-Level Input Voltage): 0.8 V
 Polarity: Lo Active

When mode PULSE SYNC is used LED brightness is set to 150 %.

The shutter output of industrial high speed cameras can be used as trigger signal for the PULSE SYNC.

By utilizing pulsed light optimal lighting conditions for industrial cameras can be accomplished without being too bright or disturbing for the human eyesight.

In order to use PULSE SYNC the **SYNC mode switch** has to be set to position **SYNC**.

Pin Assignment

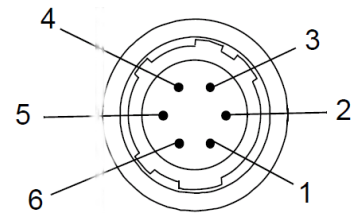

6-Pin Socket

Pin4: Input
 Pin5: GND

Socket Type

HIROSE HR10A-7P-6S

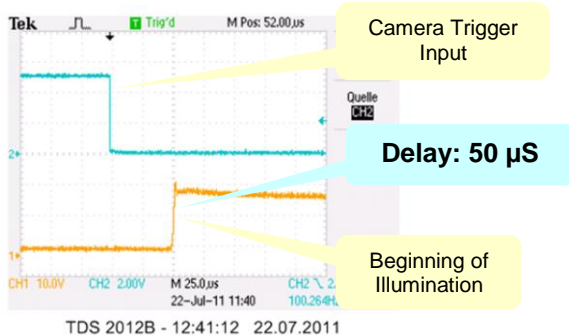

Timing Properties when switching the Light **ON**:

Delay of 50 µs

The cameras Trigger-Output should be preset to this value.

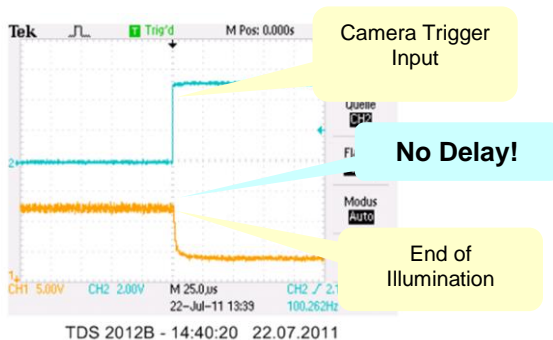

Timing Properties when switching the Light **OFF**:

No Delay (0 µs)

No adjustment of Trigger-Output necessary!

5 Gait Training Module

For the gait training and the feedback training (virtual Forestwalk) a projector unit can be mounted to the treadmill frame. In order to accomplish adapters individually engineered for different treadmill types are necessary. The assembly of the available adapter types is described below.



NOTE

For setup, installation and safety related instructions of the projector please refer to the user manual of the projector manufacturer.

The projector is connected directly to the corresponding hardware interface (mostly HDMI or DVI). The projection during gait training is controlled by the gait training module of the zebris FDM software.



WARNING

During long periods of operation, the projector can become very hot in the area of the lamp and at the air outlet openings and thus should not be touched.



WARNING

In order to minimise the risk of falling and to prolong the lifetime of the projection lamp, the projector should only be switched on during the gait training and otherwise be switched off.



WARNING

With treadmills featuring an inverse driving direction, the projector must be separated from the mains before activating the inverse driving direction.

As with installed projector and activated inverse driving direction a higher risk of injury through falling exists because of the projector, a safety (safety bow with chest strap) should always be used with treadmills featuring an inverse driving direction.

5.1 Gait Training Type M and L (h/p/cosmos mercury und locomotion)

Accessories for gait training through visual cueing with treadmill type h/p/cosmos mercury.

Fixing the projector mount

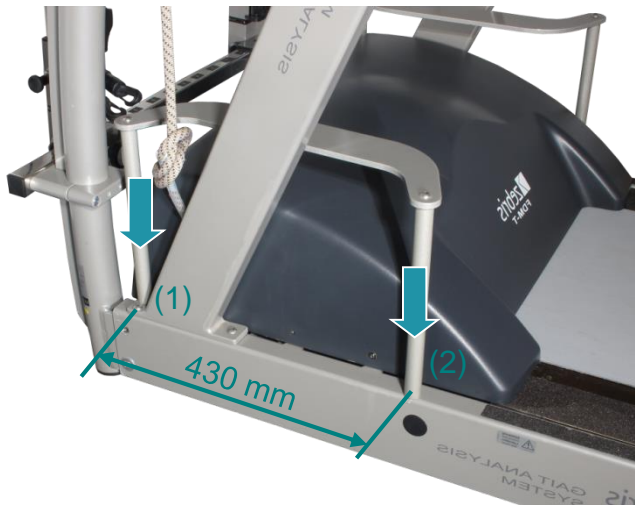

Required tools:

- Allen Key 6 mm / 8 mm
- Drill Ø 5.0 mm
- Tread Cutter M6

First remove screw (1) of the treadmill's handrail.

For attachment of the rear fixation pole a tapped hole (2) has to be drilled at a distance of 430 mm from the hole in front of the handrail (1).

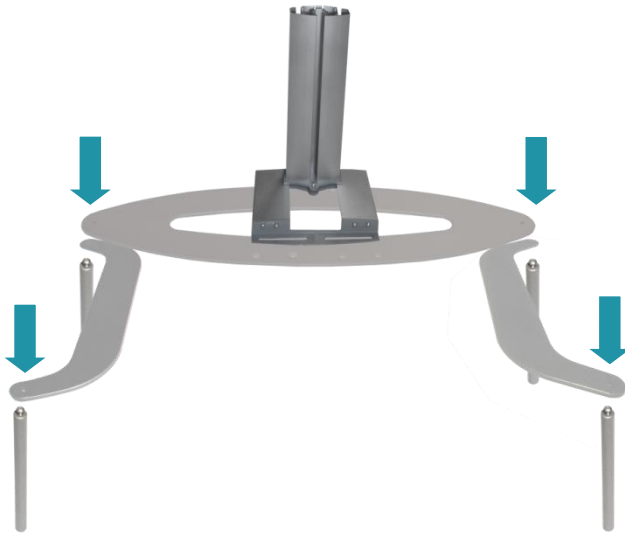

Next the components of the adapter have to be assembled in the sequence illustrated left hand side.

First screw the four fixation poles to the treadmill frame and attach the C-shaped connection pieces to the poles with the screws supplied.

Then attach the oval cross member with two screws.

At last attach the projector's stand to the cross member with the screws supplied.

For the final assembly of the projector to its stand, please refer to the user manual of the projector manufacturer.



WARNING

Please regularly check (recommended after 25 operating hours each) that all screws of the handrail and projector mount are tightly fastened.

5.2 Gait Training Type Q and P (h/p/cosmos quasar und pulsar)

Accessories for gait training through visual cueing with treadmill type h/p/cosmos quasar.

Fixing the projector mount

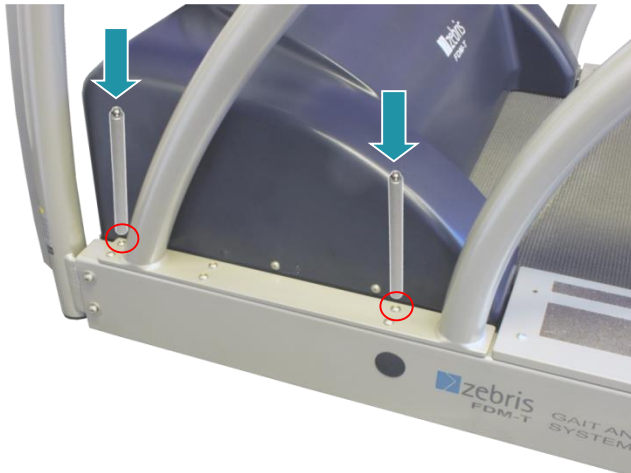

Required tools:

- Allen Key 6 mm
- Phillips Screw Driver

First remove the screws marked in red from the hand rails of the treadmill.

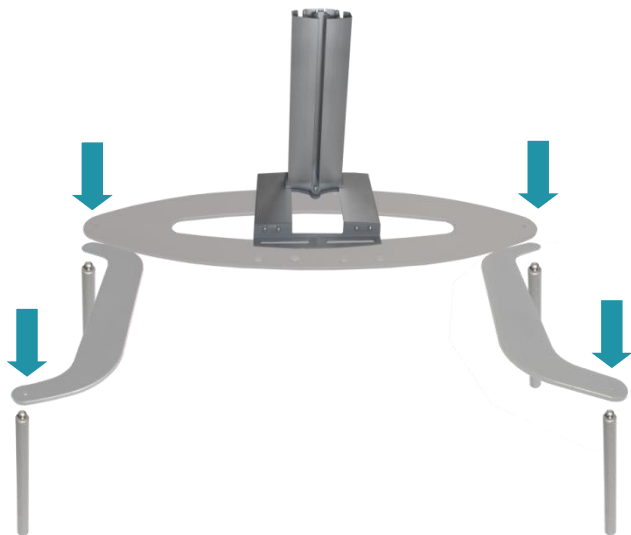

Next the components of the adapter have to be assembled in the sequence illustrated on the left hand side.

First screw the four fixations poles to the treadmill frame and attach the C-shaped beams to the poles with the screws supplied.

Then attach the oval cross beam with two screws.

At last attach the projector's stand to the cross beam with the screws supplied.

For the final assembly of the projector to its stand, please refer to the user manual of the projector manufacturer.



WARNING

Please regularly check (recommended after 25 operating hours each) that all screws of the handrail and projector mount are tightly fastened.

5.3 Gait Training Type D (daum ergo_run)

Accessories for gait training through visual cueing with treadmill type daum ergo_run.

Fixing the projector mount

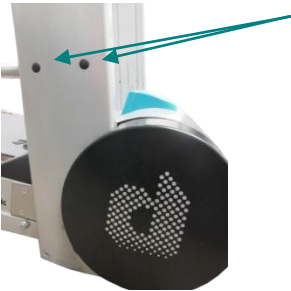

Required Tools: Allen Key 4 mm, 5 mm

To begin with remove the cover of the fixation screws for the hand rails on both sides of the treadmill.



Use an Allen key size 5 mm for this step

Attach the projector adapter to the main columns by utilizing the screws supplied (bolts DIN 912 M6x45 with Allen screw).

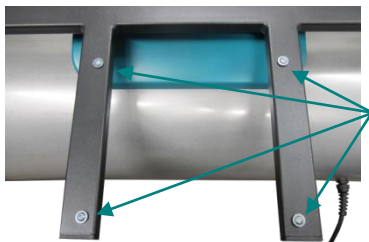

Use an Allen key 4mm for this step

Next remove the screws already fixed on the mount.

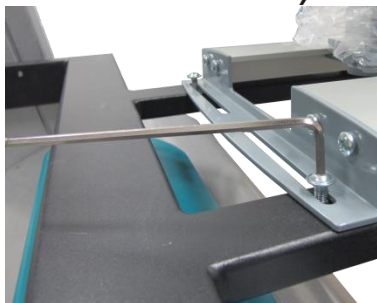

Place the projector's stand as illustrated on the left-hand side and fix it with the screws removed previously.

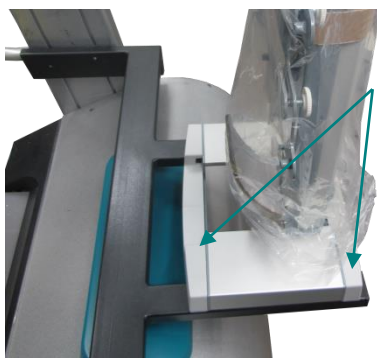

After attaching the covers the assembly of the stand is finished.

For the final assembly of the projector to its stand please refer to the user manual of the projector manufacturer.



WARNING

Please regularly check (recommended after 25 operating hours each) that all screws of the handrail and projector mount are tightly fastened.

6 Setup and Operation of the FDM-T System

6.1 Positioning of the measuring system



NOTE

For setup, installation and safety related instructions of the treadmill please refer to the user manual of the treadmill manufacturer.



WARNING

A safety zone of at least 2 m in length and 1 m in width must be kept free directly behind the treadmill. No items may be left in this zone (video camera, etc.).



WARNING

It is strictly prohibited to embed the treadmill in the floor in order to reduce access height. This way of installation might create a highly dangerous capture area at the rear guide pulley of the treadmill. The manufacturer expressly will undertake no liability for injuries to any person when the treadmill is operated under such condition!

- Preferably place a gym mat or other padding in the safety zone behind the treadmill in order to soften falls.
- The floor where the device is installed must be absolutely even and horizontal.
- The belt of the treadmill must be checked after installation, or if the treadmill is moved to another place, and adjusted if required. (Please refer to the user manual of the treadmill manufacturer for this purpose.)
- Set up the measuring system such that the socket for the mains connection is easily accessible at all times and the device can be disconnected from the power supply.
- Once the treadmill has been installed securely and is horizontally leveled, it can be connected to a suitable mains socket and set into operation.

For the commissioning of the FDM-T system for the stance and gait analysis, the associated power supply, a USB cable type A-B as well as the installation CD with the zebris FDM application software are necessary. All components are included in the scope of delivery of the FDM-T measuring system.

All cable connections of the FDM-T sensor are integrated in the interface box, which is positioned on the underside of the treadmill frame.

6.2 Installation of the detachable cable guard

The detachable cable guard will be attached to the interface box by means of the screws (3 x 6 mm) delivered with the measuring system as shown in the illustrations below.

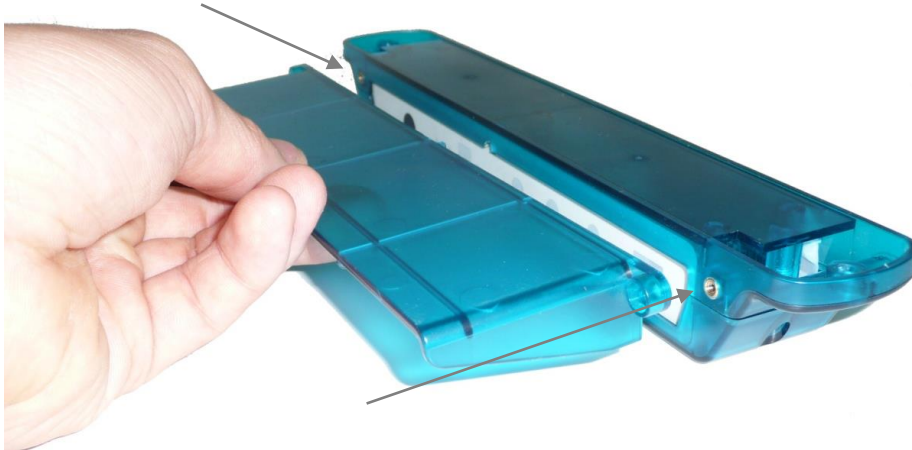

6.3 Connection of the measuring system to mains supply

6.3.1 Power supply of the FDM-T Sensors

For connecting the FDM-T sensor to the power supply, connect the power supply unit to the mains socket and the power socket on the interface box.



WARNING

For operating the FDM-T sensor, exclusively use the power adapter approved by zebris, which is suitable for the power supply of all FDM-T systems.

REF.-No. 33102024 / Mascot type 2420

Input	Output	Cable	Length
100 - 240 V AC	16 V DC	Mains lead	1.7 m
50 - 60 Hz	60 W	DC lead	5 m

Pin arrangement / polarity



NOTE

Before connecting the measuring system to the power supply, compare the nameplate specifications on the power supply unit and on the treadmill regarding the mains voltage and mains frequency, with the local characteristics. Connect only if they are compatible.



WARNING

Before connecting or using the measuring system, carry out a visual check of the power supply unit, power supply cable and socket, as well as the earthing contacts. Damaged power supply units, cables or plug and socket devices are to be replaced immediately by an authorized person.

6.3.2 Connection of the System

For connecting the treadmill to the power supply, please additionally observe the respective instructions in the user manual provided by the treadmill manufacturer.



WARNING

The connection of the treadmill and the FDM-T power supply unit must be done at a separate wall socket. It is not permissible to use extension cables and/or multiple sockets.



WARNING

For connecting the different system components to the mains supply it is absolutely essential to stick to the following illustration exactly, in order to avoid the patient coming into contact with any dangerous touch currents. For further information on this, please see Section 8.2 of this user manual. It is essential to observe the strict separation between the power supply of the system components that must be within the vicinity of the patient surroundings (treadmill incl. platform) and those that must be outside the patient's vicinity (PC, video camera, illumination).

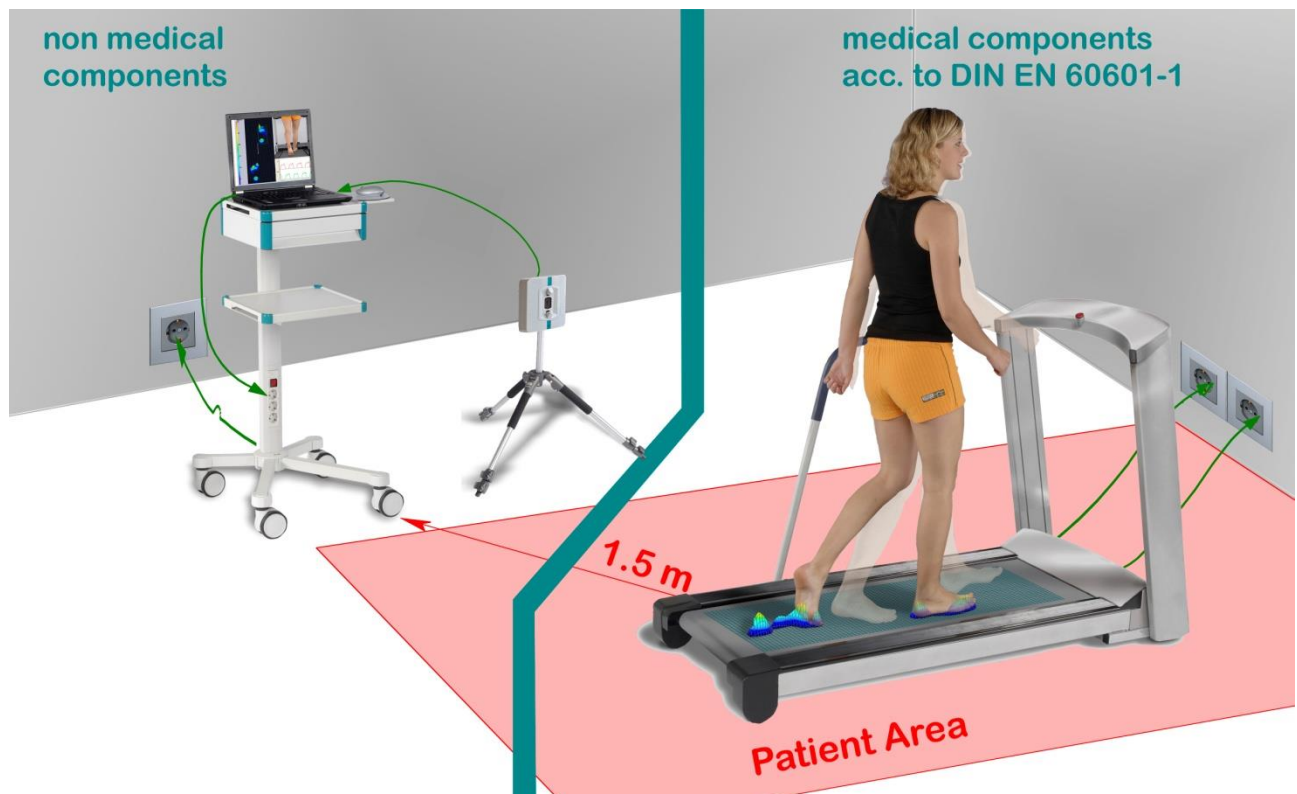

WARNING

Set all connection cables in a way that prevents patients, or persons taking part in the measuring procedure from tripping over them or damaging them mechanically. For this purpose, run the cables using cable protections or if necessary fasten the cables with adhesive tape to the floor.

6.4 Computer Requirements

If the FDM-T system is not delivered with a computer that includes pre-installed zebris FDM software, the user must then inquire whether the intended coupling guarantees the necessary safety for the test person, the operator and the surroundings by consulting the manufacturer, the authorized zebris sales partner or by asking a specialist.

The requirements for the PC are specified in the user manual of the zebris FDM software.



WARNING

If the computer is not supplied with the measuring system, the manufacturer shall not be held liable for any damage or malfunctions that result from defective software installation or incompatible hardware. Should additional hardware be built into the computer or third party software be installed, the manufacturer shall not be liable for any malfunctions or damage occurring thereof.

The computer must carry CE mark and meet the standards DIN EN 60950 or DIN EN 60601-1.



WARNING

The FDM-T measuring system is not intended for operation in a network/data network. Connecting the system to a network/data network can cause unforeseen risks for the patient or third persons. If the database of the zebris FDM-T software is to be installed in a network/data network, the operator is then obligated to determine, analyse, assess and overcome any risks in this connection. Of particular importance are aspects concerning data protection, virus security, updates of the operating system and regular backups. The risk considerations must also include any changes made to the network/data network, e.g. update/upgrade of devices and components that are connected to the network.

6.5 Installing the zebris FDM software

If your measuring system is delivered without PC/laptop, please install the application software before connecting the measuring system to the computer. Please find information on the installation in the user manual of the zebris FDM software.



Note

Please make absolutely sure that you have installed the zebris software before connecting the FDM-T sensor to the computer using the USB cable.

If the FDM-T sensor is connected without installing the software first, problems when installing the device driver may occur and the system does not work.



Note

Should problems with the hardware driver of the FDM-T platform occur then disconnect the platform from the PC and restart it. Now proceed with installing the zebrisFDM software again and reestablish the USB connection.

Finally connect the Interface box and a free USB interface of your computer by using the provided USB cable. Your measuring system is now ready for use. The control of a measurement exclusively is carried out via the zebris FDM software. Therefore, please carefully read the zebris FDM user manual.

6.6 How to switch the FDM-T sensor On/Off

The FDM-T sensor is switched on and off by software control as soon as the zebris FDM software on the PC is started or shut down.

If the device has been connected correctly, the green power LED lights up on the interface box. For further details on preparing a measurement platform, please see the section "Recommendations for recording data".

6.7 Setting the system out of operation

In order to set the system out of operation, please close the zebris FDM software first, then exit the Windows operating system and shut down the PC. In the next step disconnect the power supply unit of the FDM sensor and the treadmill from mains supply.

6.8 Recommendations for recording

There are a few things one should bear in mind for obtaining significant measuring results using the FDM-T system. The following points relate to the data recording of a person while walking and describe the ideal measuring situation.

6.8.1 Treadmill Analysis

Walking on the treadmill is unfamiliar to most people and takes a certain time to get used to it. It is therefore of advantage to familiarize the test person with this new type of externally controlled movement of the treadmill before recording any data.

6.8.2 Data Recording

Also observe the test person during the measurement. Only use data recordings where the foot does not extend beyond the sensor surface during roll-off.

6.8.3 Walking Speed

The walking speed during the measurement should correspond to the person's normal walking speed. It usually takes a few minutes for the test persons to be relaxed enough for finding their normal movement pattern again. It may well be that their speed increases during the measurement. This should be avoided by carefully making sure that the test person feels at ease before the measuring begins. During the data recording the speed should not fluctuate by more than 5%.

6.8.4 Posture

The test person should adopt a relaxed posture, with the arms swinging in a natural way. Make sure that the test person looks straight ahead and not to the ground, the treadmill or the screen, as this can influence the natural gait pattern.



Persons who are unsteady on their feet should make sure to hold onto the handrail while walking on the treadmill in order to avoid any danger of stumbling!

Basically, the safety features of the treadmill have to be used (safety clip for emergency stop, crash bar).

6.8.5 Weals

Studies have proven that the peak plantar pressure is increased by 30 % through calluses on the foot (P.R. Cavanagh, *The Foot* (1994) 4, 123-135). This information should be taken into account during the measuring procedure.

7 Maintenance and Safety Inspections



- Scheduled maintenance of the system is essential in order to prevent damage and guarantees the safety of the device. All processes concerning maintenance and disinfection of the device should be carried out regularly.
- Should any malfunctions and/or defects be determined or suspected, the device must be put out of operation immediately, marked as "Out Of Service" and prevented from being used by removing the mains cable. In such case be sure to contact the manufacturer or an authorized sales partner.
- All maintenance and repair work of the measuring system or of single components that goes beyond the activities described in this user manual must exclusively be carried out by zebris Medical GmbH or a person who has been explicitly authorized by zebris to do so.
- Be sure to switch off the measuring system and disconnect it from mains supply before starting any maintenance work.

7.1 General Maintenance Procedures

- Immediate maintenance procedures are to be carried out if:



- a) fluid enters the device.
 - b) cable or cable connections have been damaged.
 - c) covers have been damaged or have fallen off.
 - d) the running belt shows any signs of wear or cracks.
 - e) the running belt no longer runs centrally.
 - f) the sliding surface underneath the treadmill belt is no longer sufficiently lubricated.
 - g) a malfunction or a defect is suspected or has been detected.
- Check regularly (approx. every 25 operating hours) whether all the screws are tight, the belt tension is sufficient and the running belt is correctly centered. For the exact sequence of these maintenance procedures, please refer to the user manual supplied by the treadmill manufacturer.
 - In order to keep the friction between the running belt and the FDM-T sensor as low as possible, the system must be lubricated at regular intervals with silicone oil. zebris recommends lubricating at least every 6 months. For detailed information concerning the lubrication procedure please refer to the user manual of the treadmill manufacturer.
 - Should the treadmill be relocated to another place, it is necessary to check that the belt is running correctly. The belt should always run centrally on the rear guide pulley.
 - After a longer period of use, or if the adjustment is suboptimal, the belt can loosen and with every step, a jolt can occur between the drive shaft and the belt. This can possibly influence the measuring result of the system. Therefore control the belt tension regularly in accordance with the instructions supplied by the treadmill manufacturer.
 - Should you hear "mechanical knocking sounds" during operation, check whether the device is standing level on the ground as incorrectly adjusted feet may often cause knocking noises.

7.2 Mandatory periodic inspections and STK

- For maintaining the correct state of the electrical equipment, checks and technical safety inspections have to be carried out repeatedly (e.g. within Germany, acc. to BGV A3, and accident prevention regulations and technical safety tests according to the Medical Device Operating Regulations). Here it should be noted that standard regulations for electrical devices are concerned here and not measures that are specific to zebris. 
- Before each use of the measuring system it is recommended for safety reasons to check the correct state of all the connection cables, as well as the mains cable, mains plug and mains socket. Should certain parts be damaged, they must be replaced before continuing to use the measuring system.
- Regular technical safety checks are compulsory for the treadmills. These checks may only be carried out by an authorized qualified electrician. For further information please see the user manual supplied by the treadmill manufacturer.
- For the FDM-T force sensors, no technical safety tests are stipulated by zebris Medical GmbH.
- If the type plate or other important labels (e.g. warning notes) are damaged or illegible they have to be replaced by the manufacturer for safety reasons.
- Each treadmill has an anti-slip area alongside the running surface on both sides. These stepping areas offer a firm hold when getting off the treadmill in emergencies. Check this anti-slip area at regular intervals and replace it immediately if it shows signs of wear.

7.4 Maintenance of the FDM-T Sensor

7.4.1 Control Procedures



WARNING

The measuring system must be checked at regular intervals to ensure its correct function and patient safety.

In case the running belt has been exposed to hard knocks or heavy items have fallen onto it, the surface of the FDM-T sensor has to be checked for damaging (cracks, dents, and scratches on the surface). If visible damages are detected, no further measurements must be carried out.

After carrying out a zero measurement, no measuring values may be shown for a condition without any load. In addition, the force distribution images are to be checked regularly for untypical measuring patterns. These include above all, line or column-shaped measuring patterns deviating from the surrounding values.



NOTE

In order to guarantee the correct functioning of the speedometer in the long term, the central position of the belt must be checked monthly according to the instructions supplied by the treadmill manufacturer, and readjusted, if required.

Whenever faults occur or in case of doubt, the manufacturer or sales partner authorized by zebris must always be contacted.

7.4.2 Calibration Procedures

The measuring accuracy of the FDM-T sensors is to be checked from time to time using a defined application of force.

To do so, the user can stand on the platform on one foot. Provided that he knows his body-weight the platform must then show the approximate body weight, taking the force of gravity, the sensors at the edges that may not be under full pressure, and the measuring tolerance into consideration.

In case the measuring results show deviations larger than $> \pm 5 \%$ of the full measuring range, a recalibration by the technical service of zebris Medical is required.

If any doubt exists about the measuring accuracy of the FDM-T sensor, it is recommended to have the force distribution measuring sensors checked and re-calibrated by zebris, in order to ensure the specified measuring accuracy.



NOTE

On request, service instructions for the assembly and disassembly of the FDM-T sensor can be supplied for various treadmill types, so that maintenance and repair work can be carried out by trained personnel on site.

7.5 Troubleshooting

In the case of faults, please check the following points first:

- ✓ Are the FDM-T sensor and treadmill connected correctly to the mains?
(Green Power LED on the interface box and power switch on the treadmill lights up.)
- ✓ Is the USB connection between the interface box and the measuring PC correct?
(Green USB LED lights up when the USB is connected to the PC and the device driver is correctly installed.)
- ✓ Are all the other components of the measuring system (infrared synchronization with zebris DAB Bluetooth, video camera) connected correctly?



NOTE

For additional information on error messages and their troubleshooting, please refer to the user manual for the zebris FDM software.

Check list for noting down error messages



NOTE

In order to provide best possible support in the event of system malfunctions our service personnel will need the following information:

- ✓ Device type + serial no. of the FDM-T sensor and treadmill
The serial no. can be found on the type plates on the frame of the treadmill or on the back of the interface box.
- ✓ Version of the zebris FDM Software
- ✓ Data on the operating system of your measuring PC
e.g. Windows 7 Service Pack 1
(can be found under Start >> Properties>> Control Panel>> System)
- ✓ Further components connected to the measuring system
e.g. infrared synchronization (IR) with zebris DAB Bluetooth, video camera
- ✓ List of all the USB devices connected to the measuring PC
e.g. mouse, printer, other measuring systems, etc.
- ✓ Screenshot of the error message or exact wording
e.g. "EMG adapter not found."
- ✓ User's procedure leading to the error message
e.g. measurement "Type A" started, then clicked on button "B", then movement "C" carried out, switch-over to function "D", when switching back the described error message occurred.

7.6 Cleaning and disinfection

7.6.1 Cleaning Procedure

The treadmill and accessories are cleaned with a moist cloth while the device is switched off and the mains plug taken out.



NOTE

Do not use any aggressive agents to clean the measuring system..



WARNING

Please make absolutely sure to switch off the device and pull the mains plug out of the socket before you commence disinfecting and cleaning.

7.6.2 Disinfection Procedure

The treadmill can be disinfected by wiping over with suitable detergents. Best wipe the running belt or other parts of the treadmill with a cloth soaked with disinfection liquid. In order to remove more resistant contamination directly spray the running belt with disinfection liquid.

Recommended disinfection agent:

Composition approx. 25% ethanol, 35% propanol

E.g. Mikrozyd Liquid / Schülke & Mayr or similar solutions



NOTE

If you apply disinfectant be sure to strictly follow the recommendations provided by the manufacturer of the disinfectant. Especially consider the rules concerning the disinfectant's recommended duration of impact.



WARNING

On no account bring any disinfection fluids or other liquids in direct contact with the FDM-T sensor when cleaning.

Should any liquid enter the platform it is likely to be damaged irreparably.



WARNING

Fluids required for disinfecting and cleaning must be stored, prepared and kept ready for use exclusively in the containers provided, in order to avoid them being mistaken for other fluids.



NOTE

For confirmation that disinfection has been carried out, it is advised to place a visible sign on the running surface reading "disinfected".

7.7 Disposal

7.7.1 Packaging

All the transport packaging supplied by zebris can be recycled within Germany via the local recycling depots. In order to guarantee the re-use of the recyclables contained in the packaging, zebris Medical GmbH participates in the Dual System ZENTEK which takes over the proper disposal of the packaging.



Please find information concerning the disposal of the treadmill in the Operating Instructions supplied by the treadmill manufacturer.

7.7.2 WEEE-Directive

This symbol indicates that according to the directive on waste electrical and electronic equipment (2012/19/EEC) the product must not be disposed by means of the domestic waste system. Within Europe this device must be forwarded to a specific waste disposal system.

For this purpose the measuring system can be returned to zebris Medical GmbH at the end of its service life at the customer's own expense and will be forwarded to special recycling companies without any further costs and refund.

The improper use of old devices (measuring systems) could lead to negative effects for the environment and the public health because of potential hazardous materials which are frequently contained within electric and electronic devices. Additionally with the proper disposal of this product you will contribute to the effective use of natural resources.

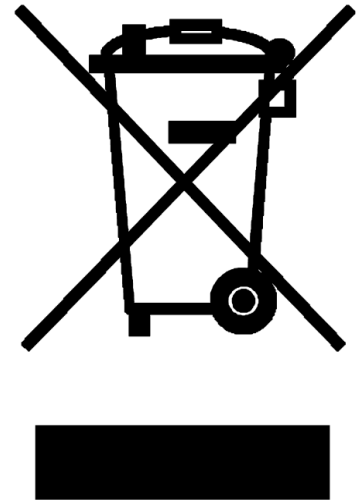

7.7.3 Accumulators and batteries

Accumulators and batteries must not be disposed of with domestic waste! In the interest of environmental protection, the consumer is legally obliged (battery regulation) to return old and used batteries. Used accumulators and batteries can be disposed of at the collecting points of the community or where batteries of the relevant kind are sold. For consumers, the batteries are taken back free of charge.

8 Safety standards and classification of the system

The following information and warnings are based on requirements of the Standard DIN EN 60601-1:2006, Section 11 for Medical Electrical Equipment and for the application of the FDM-T system for medical purposes.



NOTE

The sections 8.1 – 8.3 are only applicable for the FDM-T sensor integrated in the treadmill and the accessories listed in this User Manual. Please find information concerning the disposal of the treadmill in the Operating Instructions of the treadmill manufacturer.

8.1 Classification acc. to Annex IX of Directive 93/42/EEC

If a CE mark with a four-digit number (0535) is imprinted on the type plate of your FDM-T system it is classified as a medical product of **Class I with measuring function**.

8.2 Safety of medical electrical device

The system meets the requirements of the standards DIN EN 60601-1:2006

Classification according to DIN EN 60601-1

Type BF

Safety class II

Steady state conditions

Unsuitable for use in an oxygen-enriched atmosphere

8.2.1 Coupling of the FDM-T measuring system with other electrical devices

(also refer to DIN EN 60601-1:2006 Par. 16 Medical electrical equipment)



WARNING

The FDM-T System may only be coupled with other electrical devices if these conform to the provisions of DIN EN 60950 or DIN EN 60601-1 or zebris Medical GmbH has confirmed their compatibility.



WARNING

When coupling several devices to a measuring system, care must be taken to avoid any danger arising from the summation of the leakage currents.

In the case of devices that the patient comes into direct contact with, and that are used together in one medical, electrical system, they must adhere as a whole to all the requirements of DIN EN 60601-1:2006 Section 11.

There is a danger of an electric shock if devices are touched that have not been connected to ground separately.

8.2.2 Vicinity of the patient / test person

In practice a distance of 1.5 m surrounding the patient has been approved sufficient for defining the patient's vicinity. Within this distance only medical electrical equipment proved to be in accordance with DIN EN 60601-1 is allowed to be used.

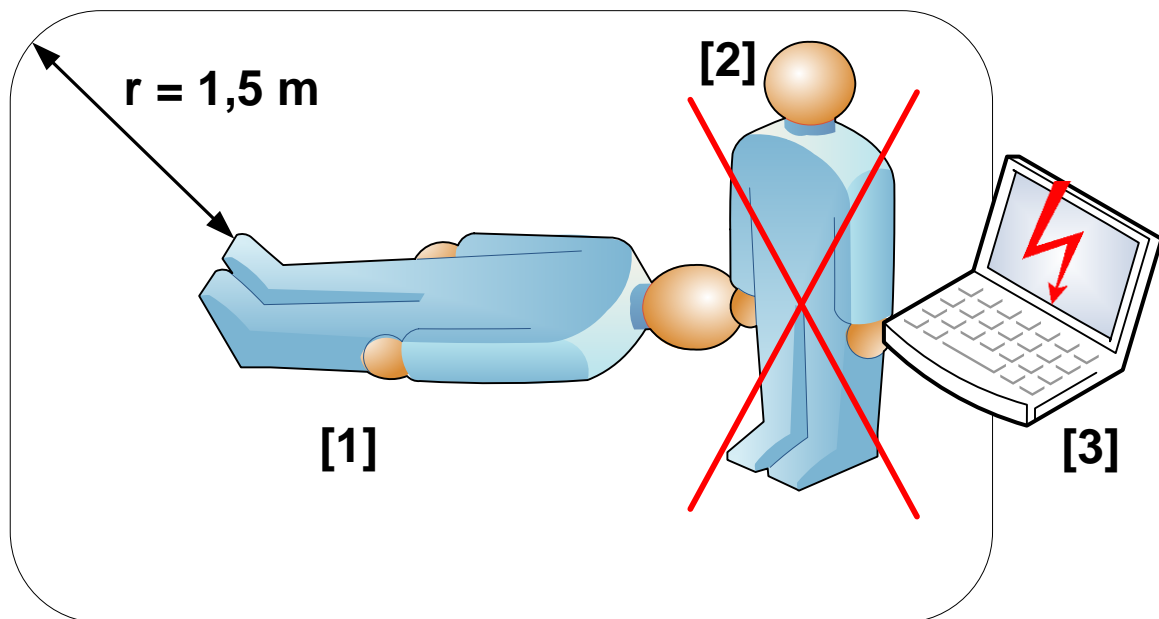

WARNING

When operating the system, the user [2] must ensure that he does not touch the PC [3] and the patient [1] at the same time. The same applies for all other non-medical, electrical components; they may only be used outside the patient's vicinity.

Furthermore, the user must ensure, never to touch the contacts of the connectors of the interface box and the patient at the same time.

In case of non-observance, dangerous leakage currents can occur.

The following components of the FDM-T system may be used in the vicinity of the patient:

- Treadmill (medical versions)
- FDM-T sensor (integrated in the treadmill)
- zebris measuring systems for medical purposes (e.g. CMS20, DAB Bluetooth)



WARNING

The computer and other non-medical electrical equipment (e.g. camera equipment, lights) have to be located beyond the reach of the patients (1.5 m).

8.2.3 Use of multiple sockets

The following information and warnings are based on the requirements of the Standard DIN EN 60601-1:2006, Section 11 for medical electrical equipment and have to be enforced when the FDM-T system is used for medical purposes.



WARNING

If multiple sockets are used for connecting the FDM-T system or its components, the following safety regulations are to be observed:

- Always connect the treadmill and FDM-T sensor directly to mains supply by using a separate wall socket with a tested protective earth conductor and separate fuse.
- Multiple sockets can be used without causing any danger for connecting the PC and other electrical accessories (video camera, illumination) outside the patients' vicinity.
- Multiple sockets must not be placed on the floor to avoid accidentally penetration of liquids or mechanical damages.
- It is forbidden to use extension cables or several multiple sockets connected in series.
- In commercially available multiple sockets, system components set up within and outside the vicinity of the patient must never be plugged in together. (Example: It is forbidden to connect the PC and the power supply unit of the FDM-T sensors to the same multiple socket.)
- If multiple sockets are used jointly for components of the FDM-T system, that are allowed to be located within the vicinity of the patient (e.g. treadmill, FDM-T sensor or other zebris measuring systems) and components that have to be outside the vicinity of the patient (e.g. PC, video camera), the multiple socket and complete interconnection of the system must adhere to all the requirements of DIN EN 60601-1:2006 Section 16. If necessary, an isolating transformer is to be used for an arrangement of this kind, and the ground leakage current in the protective earth conductor of the multiple sockets must not exceed 5 mA. The adherence to the maximum permissible patient leakage currents is to be verified by measuring. If a multiple socket was integrated after setting the system into operation for the first time, no additional device may be connected to it (use multiple sockets with locking covers for this purpose)



WARNING

It is extremely dangerous to use multiple sockets for combining the mains connection of components of Medical Electrical Equipment Systems with other components that have not been supplied at the same time.

It is possible for excessive touch currents to occur if mains are connected without the user having any respective expert knowledge.

Due to these complications zebris Medical GmbH urgently advises not to use multiple sockets for operation of the system.

8.3 Electromagnetic Compatibility / Manufacturer's Declaration

The measuring system FDM-T fulfills all requirements for EN 60601-1-2 (Medical Electrical Equipment - Part 1-2: General requirements for basic safety and essential performance - Collateral Standard: Electromagnetic compatibility - requirements and tests)

Inspecting authority: ZAMM

Zentrum für angewandte Messtechnik Memmingen GmbH

In der neuen Welt 10

87700 Memmingen

GERMANY

Detailed information on EMC values and information supplied by the manufacturer can be found in the tables in this section of the user manual.

Electrical equipment in the medical field is subject to particular precautionary measures as regards the EMC (Electromagnetic Compatibility) and must be installed and put into operation in accordance with the instructions given below.



Even though the motion analysis system FDM-T fully complies with the requirements of the standard EN 60601-1 it cannot be totally expected that portable and mobile RF communications equipment can affect the system. If ever possible such devices should not be operated within the system environment during measurements.



The use of accessories, particularly cables for connecting to the PC, that are not supplied by zebris for use with the FDM-T system, or explicitly recommended for use with the device, can lead to a reduced resistance to EMC interference of the FDM-T system.



The FDM-T measuring system should not be operated in the vicinity of e.g. X-ray equipment, motors or transformers with a high connected load, as electrical or magnetic interference fields can influence the measurements. The same is applicable for neighboring power lines and equipment without a CE mark. Should operation next to possible sources of interferences be necessary it is mandatory to check and verify the correct function of the system.



In the case of over voltages or voltage dips (even short-term) of more than 50% of the mains voltage, functional faults can occur. When such high voltage dips or complete voltage failures occur, the measurement is interrupted and the measuring data is discarded. Finally the measurement has to be re-started, and if need be, also the connected PC.

Guidelines and Manufacturer's Statement - Electromagnetic Emission

The FDM-T force-distribution measuring system is intended for use in the electromagnetic environment described below. The customer or user of the FDM-T force-distribution measuring system should ensure that it is operated in such an environment.

Emitted interference measurements	Compliance	Electromagnetic environment guidelines
RF emissions acc. to CISPR 11	Group 1	The FDM-T force-distribution measuring system uses RF energy exclusively for its internal functions. Therefore its RF emission is very low and it is unlikely that electronic equipment in close proximity will experience interference.
RF emissions acc. to CISPR 11	class B	The FDM-T force-distribution measuring system is intended for use in all facilities including those in residential areas and those directly connected to a public utility network also supplying buildings used for residential purposes.
Emission of harmonic oscillations acc. to IEC 61000-3-2	class B	
Emission of voltage fluctuations / flickers acc. to IEC61000-3-3	in compliance	

Guidelines and Manufacturer's Statement - Electromagnetic Interference Immunity

The FDM-T force-distribution measuring system is intended for use in the electromagnetic environment described below. The customer or user of the FDM-T force-distribution measuring system should ensure that it is operated in such an environment.

Interference immunity tests	IEC 60601 test levels	Compliance level	Electromagnetic environment guidelines
Electrostatic discharge (ESD) acc. to IEC 61000-4-2	± 6 kV contact discharge ± 8 kV atmospheric discharge	± 6 kV contact discharge ± 8 kV atmospheric discharge	Flooring should be of wood or concrete or laid with ceramic tiles. If the flooring is made of synthetic material, the relative humidity must be at least 30%.
Fast transient electrical interferences/bursts acc. to IEC 61000-4-4	± 2 kV for power lines ± 1 kV for input and output lines	± 2 kV for power lines ± 1 kV for input and output lines	The quality of the supply voltage should be the same as the voltage of a typical business or hospital environment.
Surges acc. to IEC 61000-4-5	± 1 kV differential mode voltage ± 2 kV common mode voltage	± 1 kV differential mode voltage ± 2 kV common mode voltage	The quality of the supply voltage should be the same as the voltage of a typical business or hospital environment.
Blackouts, brownouts and fluctuations of the power supply acc. to IEC 61000-4-11	< 5% U_T (> 95% crash of the U_T) for ½ period 40% U_T (60% crash of the U_T) for 5 periods 70% U_T (30% crash of the U_T) for 25 periods < 5% U_T (> 95% crash of the U_T) for 5 s	< 5% U_T (> 95% crash of the U_T) for ½ period 40% U_T (60% crash of the U_T) for 5 periods 70% U_T (30% crash of the U_T) for 25 periods < 5% U_T (> 95% crash of the U_T) for 5 s	The quality of the supply voltage should be the same as the voltage of a typical business or hospital environment. If the user of the FDM-T force-distribution measuring system requires the continuation of functionality also after power interruptions/disruptions, it is recommended to provide the FDM-T force-distribution measuring system with power from an uninterruptible power supply.
Magnetic field with supply frequency (50/60 Hz) acc. to IEC 61000-4-8	3 A/m	Not tested as no influence is possible on the device within the specified test level. (see Note B)	Magnetic fields of the mains power frequency should comply with the typical values of a business and hospital environment.

NOTE U_T is the AC main voltage prior to applying the test levels.

Guidelines and Manufacturer's Statement - Electromagnetic Interference Immunity

The FDM-T force-distribution measuring system is intended for use in the electromagnetic environment described below. The customer or user of the FDM-T force-distribution measuring system should ensure that it is operated in such an environment.

Interference immunity tests	IEC 60601 test levels	Compliance level	Electromagnetic environment guidelines
			Portable and mobile wireless sets should not be used in closer proximity to the FDM-T force-distribution measuring system, including the cables, than the recommended safety distance, that is calculated on the basis of the formula suitable for the transmitting frequency. Recommended safety distance:
Conducted RF interference quantities acc. to IEC 61000-4-6	3 V _{eff} 150 kHz to 80 MHz	3 V _{eff}	$d = 1.2\sqrt{P}$
Radiated RF interference quantities acc. to IEC 61000-4-3	3 V/m 80 MHz to 2.5 GHz	3 V/m	$d = 1.2\sqrt{P}$ 80 MHz to 800 MHz
			$d = 2.3\sqrt{P}$ 800 MHz to 2.5 GHz
			With P as the rated output of the transmitter in watts (W) according to the information provided by the manufacturer of the transmitter and d as the recommended safety distance in meters (m). The field strength from fixed RF transmitters as determined by an electromagnetic site survey ^a is less than the compliance level ^b in all the frequencies. Interference is possible in the proximity of devices featuring the following pictograph
NOTE 1	The higher value applies in the case of 80 MHz and 800 MHz		
NOTE 2	These guidelines may not be applicable in all situations. The spread of electromagnetic waves is influenced by absorption and the reflections of buildings, objects, and people		
a	The field strength of stationary transmitters, such as the base stations of mobile phones and land mobile services, ham radio stations, AM and FM radio and TV broadcasters is theoretically not 100% predictable. A site study is recommended to determine the electromagnetic environment as a result of stationary RF transmitters. If the measured field strength at the site of the FDM-T force distribution measuring system exceeds the compliance levels listed above, the FDM-T force distribution measuring system must be monitored to document its proper functionality at every place of application. Additional measures might become necessary, e.g. modifying the orientation or moving the location of the FDM-T force-distribution measuring system, if unusual performance characteristics are observed.		
b	The field strength is less than 3 V/m for the frequency range of 150 kHz to 80 MHz		

Recommended Safety Distances between Portable and Mobile RF Telecommunications Devices and the FDM-T/FDM-T force-distribution measuring system

The FDM-T force-distribution measuring system is intended for use in an electromagnetic environment where RF interference quantities are controlled. The customer or user of the FDM-T force-distribution measuring system can contribute towards preventing electromagnetic emissions by complying with the minimum distance between portable and mobile RF telecommunications devices (transmitters) and the FDM-T force-distribution measuring system, as recommended below in accordance with the maximum output power of the communication device.

Rated output of the transmitter (W)	Safety distance based on the transmitting frequency (m)		
	150 kHz to 80 MHz $d = 1.2\sqrt{P}$	80 MHz to 800 MHz $d = 1.2\sqrt{P}$	800 MHz to 2.5 GHz $d = 2.3\sqrt{P}$
0.01	0.12	0.12	0.23
0.1	0.38	0.38	0.73
1	1.2	1.2	2.3
10	3.8	3.8	7.3
100	12	12	23

The safety distance for transmitters with a rated output not listed in the table above, can be calculated by applying the formula corresponding to the respective column, whereby P is the rated output of the transmitter in watts (W) as specified by the transmitter manufacturer.

NOTE 1 For calculating the recommended safety distance of transmitters in the frequency range of 80 MHz to 2.5 GHz, an additional factor of 10/3 was used to reduce the probability of a mobile/portable telecommunications device taken unintentionally into the patient's area, causing interference.

NOTE 2 These guidelines may not be applicable in all situations. The spread of electromagnetic waves is influenced by absorption and the reflections of buildings, objects, and people.

8.4 Declaration of conformity medical line (M)

EG - KONFORMITÄTSERKLÄRUNG EC - DECLARATION OF CONFORMITY



Hersteller / manufacturer

zebris Medical GmbH
Am Galgenbühl 14
88316 Isny
Deutschland / Germany

Wir erklären in alleiniger Verantwortung, dass / We declare under our sole responsibility that

Medizinprodukt / medical device

Kraftverteilungsmesssystem FDM-T
Force Distribution Measurement System FDM-T

Modell/Typ / Model/Type

FDM-THM-M-2i	FDM-THM-M-3i
FDM-THL-M-2i	FDM-THL-M-3i
FDM-THQ-M-2i	FDM-THQ-M-3i
FDM-THP-M-2i	FDM-THP-M-3i
FDM-TF1.6-2i	FDM-T1.6-3i
FDM-TF1.8-2i	FDM-T1.8-3i

UMDNS Nummer / UMDNS Code

17-242

Klassifizierung / classification

Im

nach Regel / according to rule

12

den Anforderungen der unten genannten Richtlinien / Normen soweit anwendbar entspricht.
meets all requirements of the directives and standards listed below which apply to it.

Konformitätsbewertungsverfahren nach /

Richtlinie 93/42/EWG Anhang V
geändert durch Richtlinie 2007/47/EWG
Directive 93/42/EEC Annex V
amended by Directive 2007/47/EEC

conformity assessment procedure acc. to

Angewandte harmonisierte Normen /
Applied harmonized standards

DIN EN 957-1	DIN EN 15223-1
DIN EN 957-6	DIN EN 60601-1
DIN EN 1041	DIN EN 60601-1-2
DIN EN 10993-1	DIN EN 60601-1-6
DIN EN 13485	DIN EN 62304
DIN EN 14971	DIN EN 62366

Diese Konformitätserklärung gilt für alle oben gelisteten Medizinprodukte welche am oder nach dem Ausgabedatum von zebris hergestellt worden sind. Die Gültigkeit dieser Konformitätserklärung endet mit der Veröffentlichung einer Konformitätserklärung neueren Datums, falls dies durch technische Änderungen am Produkt oder durch Änderungen von Richtlinien oder Normen erfolgen muss, spätestens jedoch mit Ablauf des CE-Zertifikats nach Richtlinie 93/42/EWG mit Nr. CE 573437.

This declaration of conformity is valid for all medical devices listed above which have been manufactured by zebris at or after the date of issue. The validity of this declaration expires with the release of a new declaration due to technical or legal amendments – however latest at the expiry date of the CE-certificate according to directive 93/42/EEC with certificate number CE 573437.

D-88316 Isny, 20. November 2015

Wolfgang Brunner
Geschäftsführer / Managing Director
zebris Medical GmbH

Benannte Stelle / Notified Body
BSI Group Deutschland GmbH
D-60314 Frankfurt am Main

0535

8.5 Declaration of conformity sports line (S)

EG - KONFORMITÄTSERKLÄRUNG EC - DECLARATION OF CONFORMITY



Hersteller / manufacturer **zebris Medical GmbH**
Am Galgenbühl 14
88316 Isny
Deutschland / Germany

Wir erklären in alleiniger Verantwortung, dass / We declare under our sole responsibility that

Produktname / Product name **Kraftverteilungsmesssystem FDM-T
Force Distribution Measurement System FDM-T**

Modell/Typ / Model/Type **FDM-TLR3-3i FDM-TDSL-3i
FDM-TDS-2i FDM-TDS-3i
FDM-THM-S-2i FDM-THM-S-3i
FDM-THQ-S-2i FDM-THQ-S-3i**

den Anforderungen der unten genannten Richtlinien / Normen soweit anwendbar entspricht.
meets all requirements of the directives and standards listed below which apply to it.

Konformitätsbewertungsverfahren nach / **Richtlinie 2004/108/EG und Richtlinie 2006/95/EG**
conformity assessment procedure acc. **Directive 2004/108/EEC and Directive 2006/95/EEC**

Angewandte Normen / **DIN EN 957-1 DIN EN 55024**
Applied Standards: **DIN EN 957-6 DIN EN 50081-1**
DIN EN 9001 DIN EN 50081-2
DIN EN 55022 DIN EN 60950-1

Das Qualitätsmanagementsystem der zebris Medical GmbH erfüllt alle Anforderungen von DIN EN ISO 9001, ist zertifiziert und jährlich überwacht durch BSI Group Deutschland GmbH, Frankfurt.

Diese Konformitätserklärung gilt für alle oben gelisteten Produkte welche am oder nach dem Ausgabedatum von zebris hergestellt worden sind. Die Gültigkeit dieser Konformitätserklärung endet mit der Veröffentlichung einer Konformitätserklärung neueren Datums, falls dies durch technische Änderungen am Produkt oder durch Änderungen von Richtlinien oder Normen erfolgen muss.

The quality management system of zebris Medical GmbH fulfills all requirements of DIN EN ISO 9001 and is certified and annually monitored by BSI Group Deutschland GmbH, Frankfurt.

This declaration of conformity is valid for all products listed above which have been manufactured by zebris at or after the date of issue. The validity of this declaration expires with the release of a new declaration due to technical or legal amendments.

D-88316 Isny, 20. November 2015

Wolfgang Brunner
Geschäftsführer / Managing Director
zebris Medical GmbH

