

Specifications and Operating Instructions (Med)



FDM-T SYSTEM  zebris

Content

1	INTRODUCTION	4
1.1	MANUFACTURER INFORMATION	4
1.2	STRUCTURE OF THE FDM-T SYSTEM USER MANUAL	5
1.3	CONVENTIONS AND SYMBOLS USED	6
2	APPLICATION AND SAFETY	7
2.1	INTENDED USE	7
2.1.1	INDICATIONS	7
2.1.2	CONTRAINDICATIONS	7
2.2	SAFETY	8
2.2.1	ENVIRONMENTAL CONDITIONS	8
2.2.2	STORAGE AND TRANSPORT	8
2.2.3	USER OBLIGATIONS	9
2.2.4	GENERAL SAFETY INSTRUCTIONS	10
2.2.5	SAFETY INSTRUCTIONS FOR THE TREADMILL	11
2.2.6	PROHIBITED USE	12
3	PRODUCT DESCRIPTION	13
3.1	SYSTEM COMPONENTS	13
3.2	SPECIFICATIONS FDM-T SENSOR	13
3.3	TECHNICAL SPECIFICATIONS FDM-T MEASURING SYSTEMS	13
3.4	MEASURING PRINCIPLE FDM-T SYSTEMS	22
3.5	CONTROLS AND CONNECTORS	23
3.6	LED INDICATOR LIGHTS OF THE INTERFACE BOX	23
3.7	ZEBRIS SYNC	24
3.7.1	SYNCHRONIZATION INPUT (SYNC-IN)	25
3.7.2	SYNCHRONIZATION OUTPUT (SYNC-OUT)	26
3.8	SPARE PARTS FDM-T SYSTEM	27
3.9	OPTIONS FDM-T MEASURING SYSTEM	28
4	VIDEO-MODULE	30
4.1	CONNECTION TO THE FDM-T SYSTEM	30
4.1.1	CONNECTION TO THE ZEBRIS SYNC CAM	30
4.1.2	CONNECTION SCHEME SYNC LIGHT CAM	31
4.2	SYNCCAM	32
4.3	SYNCCAM HS	33
4.4	SYNCLIGHTCAM – VARIANT 30 HZ	35
5	GAIT TRAINING MODULE	38
5.1	GAIT TRAINING TYPE M/L/PL (H/P/COSMOS MERCURY, LOCOMOTION, PLUTO)	39
5.2	GAIT TRAINING TYPE Q/P/XL AND (H/P/COSMOS QUASAR, PULSAR, LOCOMOTION XL)	40
6	SETUP AND OPERATION OF THE FDM-T SYSTEM	41
6.1	POSITIONING OF THE MEASURING SYSTEM	41
6.2	INSTALLATION OF THE DETACHABLE CABLE GUARD	42
6.3	CONNECTION OF THE MEASURING SYSTEM TO MAINS SUPPLY	43
6.3.1	POWER SUPPLY OF THE FDM-T SENSORS	43
6.3.2	CONNECTION OF THE SYSTEM	44
6.4	IT SECURITY AND SOFTWARE INSTALLATION	45
6.5	HOW TO SWITCH THE FDM-T SENSOR ON/OFF	46
6.6	SETTING THE SYSTEM OUT OF OPERATION	46
6.7	RECOMMENDATIONS FOR RECORDING	47
6.7.1	TREADMILL ANALYSIS	47
6.7.2	DATA RECORDING	47
6.7.3	WALKING SPEED	47
6.7.4	POSTURE	47
6.7.5	WEALS	47
7	MAINTENANCE AND SAFETY INSPECTIONS	48
7.1	GENERAL MAINTENANCE PROCEDURES	48
7.2	MANDATORY PERIODIC INSPECTIONS AND STK	49
7.3	MAINTENANCE OF THE FDM-T SENSOR	50

7.3.1	CONTROL PROCEDURES.....	50
7.3.2	CALIBRATION PROCEDURES.....	50
7.4	TROUBLESHOOTING.....	51
7.5	CLEANING AND DISINFECTION.....	52
7.5.1	CLEANING PROCEDURE.....	52
7.5.2	DISINFECTION PROCEDURE.....	52
7.6	DISPOSAL.....	53
7.6.1	PACKAGING.....	53
7.6.2	WEEE-DIRECTIVE.....	53
7.6.3	ACCUMULATORS AND BATTERIES.....	53
8	SAFETY STANDARDS AND CLASSIFICATION OF THE SYSTEM.....	54
8.1	CLASSIFICATION ACC. TO ANNEX IX OF DIRECTIVE 93/42/EEC.....	54
8.2	SAFETY OF MEDICAL ELECTRICAL DEVICE.....	54
8.2.1	COUPLING OF THE FDM-T MEASURING SYSTEM WITH OTHER ELECTRICAL DEVICES.....	54
8.2.2	VICINITY OF THE PATIENT / TEST PERSON.....	55
8.2.3	USE OF MULTIPLE SOCKETS.....	56
8.3	ELECTROMAGNETIC COMPATIBILITY / MANUFACTURER'S DECLARATION.....	57

1 Introduction

© 2023 zebris Medical GmbH

All rights reserved. Reproduction in whole or in part only with the express permission of zebris Medical GmbH.

Illustrations of this manual may differ.

1.1 Manufacturer Information



Manufacturer

zebris Medical GmbH	Phone	+49 (0)7562 9726 - 0
Am Galgenbühl 14	Fax	+49 (0)7562 9726 - 50
88316 Isny im Allgäu	E-Mail	info@zebris.de
Germany	Web	www.zebris.de

Sales / Support

zebris Medical GmbH	Phone	+49 (0)7562 9726 - 300
Am Galgenbühl 14	Fax	+49 (0)7562 9726 - 50
88316 Isny im Allgäu	E-Mail	support@zebris.de
Germany	Web	www.zebris.de



Please always provide the serial number of the product for inquiries!

1.2 Structure of the FDM-T System user manual

The FDM-T measuring system consists of a treadmill, the pressure distribution measuring sensors, and the corresponding application software, including the PC. The sensors and treadmill can also be used completely independently of each other and feature a separate power supply and CE mark.

The user manual for the FDM-T measuring system therefore consists of several sections:

1. FDM-T specifications and hardware user manual
2. zebris FDM user manual for the application software
3. Specifications and user manual supplied by the treadmill manufacturer.
4. User manual and specifications of components like projector or PC



NOTE

Please also be sure to adhere to the user manuals supplied by manufacturers of the treadmill and the components when setting the system into operation, while using it, maintaining it, and transporting it.

The section FDM-T specifications and hardware user manual mainly contains information regarding the specifications and operation of the FDM-T pressure distribution measuring sensors and their safe operation in combination with the treadmill, as a measuring system. Instructions regarding the treadmill are restricted to the main safety and servicing measures.

The software and hardware operating instructions can be displayed in the software as online help (F1 key).

In addition, the documents are available on the enclosed installation data carrier and on-line at <https://www.zebris.de/en/info-menu/downloads/>



WARNING

Read these instructions carefully before using the product for the first time to avoid operating errors and damage.

The exact adherence to all part of the operating Instructions for the measuring system is a precondition for its intended use.

1.3 Conventions and Symbols Used



“**WARNING**” symbols indicate a potential hazard to the health and safety of the users and/or patients. The warnings describe the risks involved and those that can be avoided.



Note symbols indicate a potential hazard that can result in damage of the device. The notes explain the type of hazard and how it can be prevented.



CE mark according to EC directive 93/42 Medical devices



Manufacturer



Manufacturing Date



Device of type BF according to DIN EN 60601-1



Direct Current



USB-Interface



Do not dispose of with household waste



Refer to instructions for use.



Observe instructions for use



Item Number



Serial Number



Medical Device



US Federal law restricts this device to sale by or on the order of a physician or professional user



UDI with HIBC-Code



Swiss authorised representative

2 Application and safety

2.1 Intended Use

Main function of the pressure distribution measurement system FDM-T is the spatially resolved pressure distribution measurement under human feet for the analysis of static and dynamic strains as well as the individual gait parameters.

Operation as well as data evaluation and storage are software-aided by using a computer. The measuring systems are suitable for the use with patients that are mentally capable of following the operator's instructions without limitations in the period of application.

The patient's weight is limited by the maximum permissible weight of the treadmill. For the application of the FDM-T with children or patients with severe movement disorders, a fall stop safety is strongly recommended.

Professional facilities (medical practices, clinics, scientific institutions, rehabilitation centres, and orthopaedic specialist shops) are specified as application environment.

The application and operation of the system may only be carried out by thoroughly trained qualified personnel such as clinical doctors, physiotherapists, orthopaedic technicians which possess the ability to evaluate the output data in medical aspects as a aid for the diagnosis, treatment or patient care and taking into account the clinical history of the patient in the context of other diagnostic tests.

2.1.1 Indications

- Stance and gait analysis of the "normal" as well as the pathological stance and gait
- Diagnosis support with foot malpositions and foot corrections
- Diagnosis support and therapy of imbalances / incorrect gait pattern
- Detection of inappropriate mechanical stress and overstraining for the prevention of physical problems and for rehabilitation with disabilities after injury, accidents or surgeries.
- Support with the development, adjustment, and verification of orthopaedic aids for the individual patient care
- Balance analysis and balance training
- Gait training in combination with dynamic visual stimulation (cueing) and feedback training as therapy/rehabilitation measures after a surgery, stroke, with the Parkinson's disease as well as other neurologic geriatric and orthopaedic disorders
- Success control of therapy/rehabilitation measures

2.1.2 Contraindications

- The FDM-T system must not be applied for a barefoot measurement with patients having open wounds and/or infections on the feet.
- Use for gait training with patients having the following contraindications only after approval through a medical specialist: pregnancy, heart and/or arterial diseases, artificial joints or prosthesis, fractures, damaged discs or traumatic disease of the spine.

2.2 Safety

2.2.1 Environmental conditions

FDM-T measuring systems are suitable for application in dry interiors with level ground such as those in hospitals, doctors' surgeries, and laboratories.

Temperature	10°C to 40°C
Relative humidity	30% to 70%, non-condensing
Air pressure	700 to 1100 hPa



FDM-T systems must NOT be operated in wet zones, wet rooms (swimming pools, saunas) or climatic chambers.

Direct contact with liquids must always be avoided, as the measuring system is not protected against the entry of liquids. Liquids penetrating the device can cause fire, electrical shock, or other severe accidents.

The FDM-T system is NOT specified for the operation in vacuum, hyperbaric or altitude chambers.

The measuring systems are not intended for operation in potentially explosive atmospheres of medically used rooms or oxygen-enriched atmospheres.

The devices must not be operated in proximity to e.g., engines or transformers with a high connected load as well as mains current lines, as electrical or magnetic interference fields can falsify correct measurements resp. turn them impossible. Therefore, the devices must be protected against humidity. The ventilation slots of the treadmills must be always free, so that air can circulate freely.

2.2.2 Storage and Transport

Storage and transport of the measuring system are only to be affected in the original packaging provided by zebris.

Temperature	-20°C to +70°C
Relative humidity	max. 95%, non-condensing
Protect from moisture	



All FDM-T systems can be stored without power supply for a maximum of 6 to 9 months. After this period, the battery may be totally discharged due to lacking power supply. If the storage of the device exceeds this period, a re-programming of the treadmill control may be necessary.

2.2.3 User Obligations



- The relevant, general guidelines and/or national laws, national regulations and technical rules for the commissioning and the operation of medical products must be applied and fulfilled corresponding to the indicated purpose of the zebris product. In Germany, operators, device in-charge persons and users are obliged to operate their devices in consideration of the MPG-regulations.
- Users are obliged to:
 - ✓ observe all safety guidelines of the user manual.
 - ✓ carry out any inspection and maintenance work on a regular basis as stipulated in the user manual.
 - ✓ only use work equipment that is free of defects.
 - ✓ check the functional safety and the proper condition of the device before operating.
 - ✓ make all user manuals that are always accessible to all users and keep the manuals in close proximity of the measuring system.
 - ✓ protect him-/herself, the patient or third parties against dangers.
 - ✓ avoid a contamination through the product.
- When using the system, national legal regulations must be observed, in particular:
 - ✓ the valid industrial safety regulations.
 - ✓ the valid accident prevention measures.
- For the safety, reliability and performance of the components delivered by zebris, responsibility is assumed, if:
 - ✓ assembly, extensions, re-settings, changes, or repairs were carried out through zebris or third parties authorised by zebris, trained technicians or employees of authorised dealers. Storage and transport are only to be affected in the original packaging delivered by the manufacturer.
 - ✓ the device is operated in accordance with the user manual.
 - ✓ in case of repair, the regulations of the VDE 0751-1 “Recurrent test and test before commissioning of medical electrical equipment – general regulations” are fully complied with.
 - ✓ the components of information technology provided by the operator correspond to the technical requirements of hard and software included in this user manual and were installed and set up according to the relevant descriptions in this user manual.
 - ✓ the set-up room corresponds to the given environmental conditions of the measuring system and the valid installation regulations.
 - ✓ the FDM-T system including components is connected to the mains socket with a protective grounding conductor and is operated with the correct mains voltage.
 - ✓ exclusively the software provided by zebris as well as the components and accessory parts listed in this user manual are used together with the system.

2.2.4 General safety instructions



- The application and operation of the system and the evaluation of the measuring data and their interpretation may only be carried out by trained qualified personnel. The manufacturer assumes no liability for any injury to persons, damage to property, or loss of data due to improper use of the software, the device or its component parts.
- The patients' data and measuring data may only be copied, moved, or deleted using the database function provided by the zebris application programs. In the case of data being changed intentionally without using the database functions, the user alone bears the full risks involved.
- Measurement and analysis results should always be interpreted in the light of the clinical history of the patient and in the context of other diagnostic tests by a trained person proven and tested for their relevance.
- Should any measures for treatment be taken based on the measuring results, the measuring system may only be implemented as a supplementary means for evaluation by an expert. On no account can, or may invasively measures, or measures endangering the patient be carried out solely based on the measuring results without further verification of the measuring data by additional methods.
- Should there be any detectable damage to the device or component parts, they should be returned to the manufacturer for a safety check. It is not permissible to continue using the device or its component parts, as severe damage, and serious injuries – even lethal injuries - may result. The manufacturer or authorized sales partner must always be contacted in all cases of fault or doubt.
- If any fluids should penetrate the device, it is mandatory for the device to undergo a technical, safety test. Damaged plug connections and leads are to be replaced by an authorized service technician. The device must be put out of operation immediately, marked as "Not working" and prevented from being used by removing the mains cable. Please refer to an authorized technician immediately.
- The measuring system must be checked for a proper measuring function on a regular basis. Please find more detailed information in chapter 7 of this user manual.
- Be sure that all the mains and connection cables are laid safely and that they are protected against stepping on, so that nobody can trip over them. Check all the cables and the connection plug regularly for any damage. Damaged power supplies and cables must be replaced before further operation.
- Never insert any objects in the components of the measuring system.

2.2.5 Safety instructions for the Treadmill



- The treadmill belonging to the FDM-T measuring system is a very powerful device. For safe operation of the FDM-T system it is mandatory to adhere exactly to the safety regulations described in the following.
- The measuring procedure on the treadmill must never be commenced without a thorough instruction of the patient by trained personnel. No measurements may be taken without a supervisor.
- Do not place the treadmill on an unstable ground.
- Do not set up the system near a source of heating or in direct sunlight in front of a window as a strong rise in temperature can lead to inaccurate measuring results.
- Directly behind the treadmill it is mandatory for a safety zone of 2 m in length and 1 m in width to be kept free, and ought to be padded (with a soft mat). No items may be left in this zone during operation (such as video camera, lighting equipment etc.).
- Dangerous drawing-in gaps are located at the rear end of the running belt and along its sides and (if existing) on the elevating mechanism. Do not wear any loose clothing that could get caught up in the rollers. Make sure that if a person trips over, their long hair, loose clothing, jewellery, etc., do not encounter the rear part of the treadmill belt (e.g., wear a hair net). Due to danger of stumbling, do not place any clothing or jewellery on or within close proximity of the treadmill.
- Never use the treadmill without the safety clip being fastened to your clothing and always be sure that the folding mechanism (if existing) is properly locked during operation. (Please also be sure to read the safety instructions in the user manual supplied by the treadmill manufacturer.)
- During operation, the Emergency STOP facilities must always be within easy reach for the user and the operating personnel.
- The patient should walk slowly to begin with. Then gradually speed can be increased after a few minutes, depending on the patient's physical condition. Improper or excessive strain through tests resp. measurements can have harmful effects on health.
- Never jump onto the running belt and never jump off it whilst it is running. Never stop walking while the treadmill is running, never turn round or step sideward or backwards. Should movement patterns of this kind be necessary for your measurements, please make sure to use a type of treadmill with a safety arch, protection against falling and a "fall stop" chest belt.
- Pull out the power plug before transporting the treadmill.

2.2.6 Prohibited Use



- Improper and/or prohibited use of the measuring system is impermissible and zebris warn explicitly against all prohibitions included in this section.
- Do not try to service the treadmill in any manner other than that described in this user manual. By the removal of the protective covers, it is possible that you could expose yourself to lethal high voltages or other hazards.
- We also point out that if any changes are made to this certified device or its components without the prior written consent of zebris, your legal right to operate the device will be void. If changes are made to the device without obtaining approval, the operator is obligated to carry out suitable investigations and tests in order to guarantee safe use.
- It is prohibited to embed the treadmill in the floor to reduce (track) access height. This way of installation might create a highly dangerous capture area at the rear guide pulley of the treadmill. The zebris Medical GmbH expressly will undertake no liability for injuries to any person when the treadmill is operated under such condition!
- All applications using wheels are prohibited (cycling, wheelchair, inline skating or roll ski) as well as running shoes with spikes or studs. Besides their extremely high risk of injury, these can cause irreparable damage to the sensors.
- There should never be more than one person on the treadmill at a time once it is in operation.
- Children and animals are not allowed to use the treadmill without supervision and must maintain a safety distance of at least 5 m.
- Any manner of over-exerting the test persons is strictly prohibited. In cases of nausea and dizziness, the measuring is to be discontinued immediately and a doctor consulted.
- Any form of operation involving an increased hazard is strictly prohibited, e.g., sprinting, or also using test persons having an increased risk.
- The use of the measuring system under the influence of alcohol, drugs or narcotics is strictly prohibited.
- zebris measuring systems may not be operated in any other environmental conditions than those listed in the section "Specifications", (e.g., in wet zones, moisture-prone areas, or in climatic, vacuum, hyperbaric or decompression chambers, etc.). Direct contact with liquids must always be avoided, as the measuring system is not protected against entering liquids. Liquids entering the device can cause fire, electric shock, or other severe accidents.

3 Product description

3.1 System Components

In its basic configuration the measuring system consists of the following components:

- Treadmill with integrated sensor equipment for measuring the pressure distribution.
- Safety clip for the emergency shutdown
- Mains cable for connecting the treadmill.
- External power supply unit for the FDM-T pressure plate
- USB cable (Type A-B, 3 m long)
- zebris application software zebris FDM
- Windows-compatible computer or notebook
- Silicone oil for lubricating the belt.
- Cable guard with screws
- User manual for FDM-T system, treadmill, zebris FDM software

3.2 Specifications FDM-T Sensor

The sensors of the different FDM-T systems only vary in size of the measuring area, the number of single sensors included in the sensor module and the supported sampling frequency. All other technical specifications are identical.

Interfaces	USB synchronization input/output video synchronization infrared synchronization (optional)
Connectors	interface box on the treadmill housing frame
Measuring principle	capacitive pressure measurement
Operating voltage	16-18V DC
Power consumption	maximum 60 W (depending on the type)
Power supply via external power supply unit	100 – 240 VAC / 50/60 Hz
Accuracy of the calibrated measuring range	(1 – 80 N/cm ²) ±5 % of maximum range
Hysteresis	≤ 3%
Mechanical cross talk	-25 dB
Pressure threshold	1 N/cm ²

3.3 Technical specifications FDM-T measuring systems

With the most system types, the FDM-T sensor is available in the resolutions 1.4 sensors/ cm² (3i) and 0.6 sensors/ cm² (2i).

Type**FDM-THPL****Treadmill****h/p/cosmos pluto med**

Speed	0.5 - 18 km/h in 0.1 km/h intervals
Running surface	150 x 50 cm
Engine Power	2.2 kW
Power Supply	230 V AC, 50 Hz
Protection class	I
Weight	211 kg
Dimensions (L x W x H)	210 x 85 x 130 cm
Track access height	23 cm
Elevation	0 – 20 %
Max. user weight	200 kg
Colour	pure white RAL 9010

Version**FDM-THPL-M-3i****FDM-THPL-M-2i**

REF	01521000	01521020
	01521001	01521021

Platform

REF	01243064	01243251
Sensor Area / cm	101.6 x 47.4	101.6 x 49.5
Number of Sensors	120 x 56 / 6720	80 x 39 / 3120
Resolution	1.4 sensors/ cm ²	0.6 sensors/ cm ²
Sampling Frequency	120 / 240 Hz	120 / 240 Hz
Infrared Interface	optional IR-Box	optional IR-Box

Type**FDM-THM****Treadmill****h/p/cosmos mercury med**

Speed	0 to 22 km/h in 0.1 km/h intervals
Running surface	150 x 50 cm
Engine Power	3.3 kW
Power Supply	230 V AC, 50 Hz
Protection class	I
Weight	220 kg
Dimensions (L x W x H)	210 x 80 x 137 cm
Track access height	18 cm
Elevation	0 – 25 % (-25 % to + 25 % with option of running direction reversal)
Max. user weight	200 kg
Colour	pure white RAL 9010

Version**FDM-THM-M-3i****FDM-THM-M-2i**

REF-No.	01521200	01521230
	01521201	01521231

Platform

REF-No.	01243055	01243255
Sensor Area / cm	108.4 x 47.4	111.8 x 49.5
Number of Sensors	128 x 56 / 7168	88 x 39 / 3432
Resolution	1.4 sensors/ cm ²	0.6 sensors/ cm ²
Sampling Frequency	120 / 240 Hz	120 / 240 Hz
Infrared Interface	optional IR-Box	optional IR-Box

Type**FDM-THL****Treadmill****h/p/cosmos locomotion m**

Speed	0 to 10 km/h in 0.1 km/h intervals
Running surface	150 x 50 cm
Engine Power	3.3 kW
Power Supply	230 V AC, 50 Hz
Protection class	I
Weight	250 kg
Dimensions (L x W x H)	210 x 80 x 137 cm
Track access height	18 cm
Elevation	-15 % (-15 % to + 15 % with option of running direction reversal)
Max. user weight	200 kg
Colour	pure white RAL 9010

Version**FDM-THL-M-3i****FDM-THL-M-2i**

REF	01521400	01521420
	01521401	01521421

Platform

REF	01243050	01243250
Sensor Area / cm	108.4 x 47.4	111.8 x 49.5
Number of Sensors	128 x 56 / 7168	88 x 39 / 3432
Resolution	1.4 sensors/ cm ²	0.6 sensors/ cm ²
Sampling Frequency	120 / 240 Hz	120 Hz
Infrared Interface	optional IR-Box	optional IR-Box

Type**FDM-THQ****Treadmill****h/p/cosmos quasar med**

Speed	0 to 25 km/h in 0.1 km/h intervals
Running surface	170 x 65 cm
Engine Power	3.3 kW
Power Supply	230 V AC, 50 Hz
Protection class	I
Weight	430 kg
Dimensions (L x W x H)	210 x 105 x 137 cm
Track access height	23 cm
Elevation	0 – 28 % (-28 % to + 28 % with option of running direction reversal)
Max. user weight	200 kg
Colour	pure white RAL 9010

Version**FDM-THQ-M-3i****FDM-THQ-M-2i**

REF	01521500	01521520
	01521501	01521521

Platform

REF	01243052	01243252
Sensor Area / cm	135.5 x 54.1	132.1 x 55.9
Number of Sensors	64 x 160 / 10240	44 x 104 / 4576
Resolution	1.4 sensors/ cm ²	0.6 sensors/ cm ²
Sampling Frequency	120 / 300 Hz	120 Hz
Infrared Interface	optional IR-Box	optional IR-Box

Type**FDM-THP****Treadmill****h/p/cosmos pulsar med**

Speed	0 to 40 km/h in 0.1 km/h intervals
Running surface	190 x 65 cm
Engine Power	3.3 kW
Power Supply	230 V AC, 50 Hz
Protection class	I
Weight	460 kg
Dimensions (L x W x H)	250 x 105 x 140 cm
Track access height	23 cm
Elevation	-25 % to + 25 %
Max. user weight	200 kg
Colour	pure white RAL 9010

Version**FDM-THP-M-3i****FDM-THP-M-2i**

REF	01521600	01521640
	01521601	01521641
	01521602	01521642

Platform

REF	01243059	01243253
Sensor Area / cm	155 x 54.1	155 x 54.1
Number of Sensors	192 x 64 / 12288	128 x 44 / 5632
Resolution	1,4 sensors/ cm ²	0,6 sensors/ cm ²

Sampling Frequency

100 / 200 / 300 Hz

100 / 200 / 300 Hz

Infrared Interface

optional IR-Box

optional IR-Box

3.4 Measuring Principle FDM-T Systems

The system contains a measuring matrix consisting of capacitive pressure sensors that are arranged in columns and lines running closely next to each other. For determining the pressure distribution over the measuring matrix, the capacity proportional to the pressure exerted is determined for each individual sensor. To do this, the drive logic generates several sinus burst signals equivalent to the number of columns via the column decoder and transmits them to the respective measuring column. The analogue signal coupled into the shift register over the lines is proportional to the pressure-dependent capacity and is passed on for further processing to the control and signal-processing electronics and transmitted to the PC from there and shown on the display.

Schematic circuit diagram of the measuring system

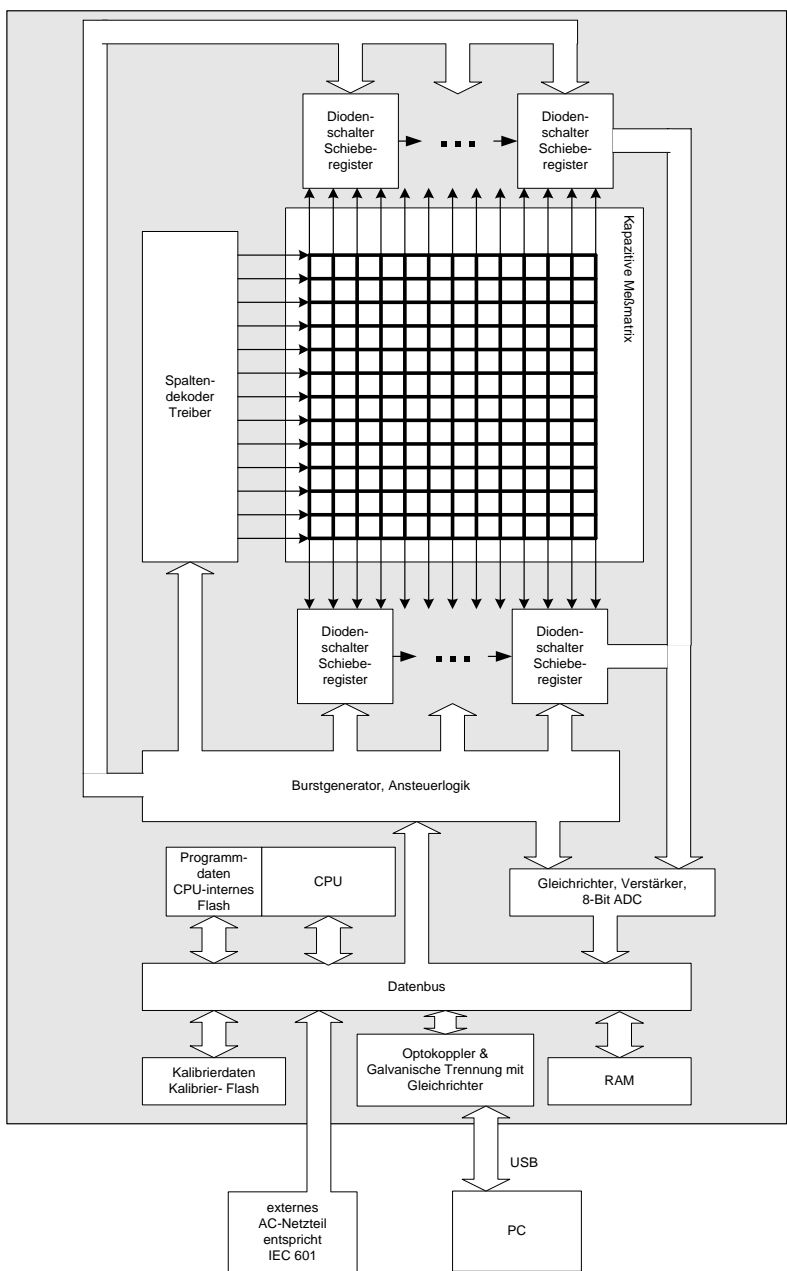

3.5 Controls and Connectors

All the cable connections are carried out via the interface box which is located on the underneath of the treadmill frame on the back.

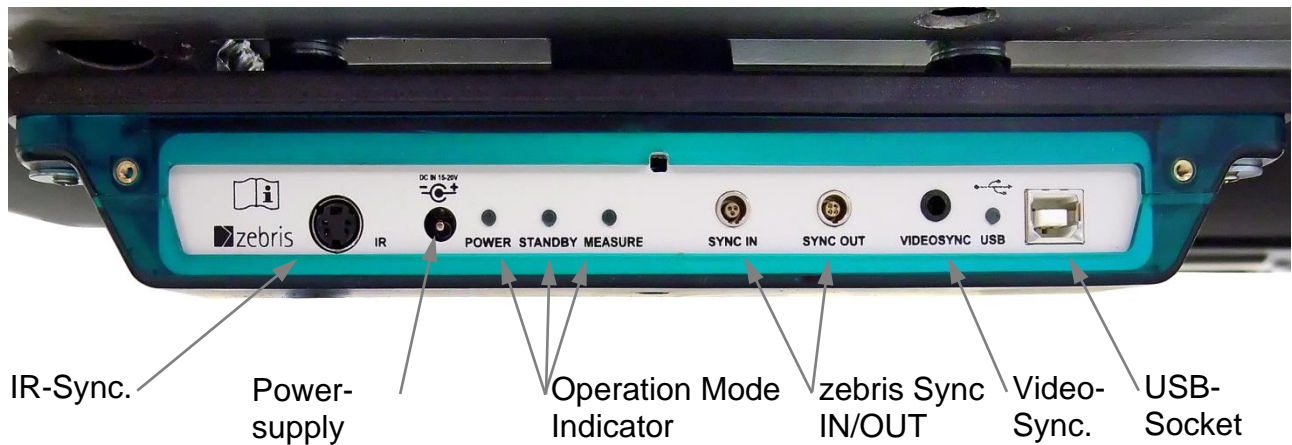

3.6 LED indicator lights of the interface box

POWER lights up as soon as the power supply unit is plugged to the interface box and connected to mains.

STANDBY lights up if the power supply unit is connected to mains, the USB socket is connected to the PC and the hardware driver of the platform is installed properly.

MEASURE lights up during the measurement.

USB lights up when the USB socket is connected to the PC and the hardware driver of the platform is installed properly.

3.7 zebris SYNC

The **zebris SYNC** is the standard solution for synchronization of the FDM-T system with third party measuring devices.

The **SYNC-IN** and **SYNC-OUT** sockets provide input and output for support of „sample by sample“ In- and Out synchronization. Both sockets provide galvanic protection between third party systems and FDM-T sensor.



WARNING

Patient's safety is guaranteed by means of galvanic separation according to the provisions of IEC 601-1 when a third-party device is synchronized with the FDM-T system. This allows non-medical equipment to be synchronized with the FDM-T system if such devices are out of patients reach. Nevertheless, the user is completely responsible for the safety of all third-party devices used in combination with the FDM-T system.

The correct synchronisation of all measurement data must be verified in case devices are connected to zebris SYNC which have not been manufactured by zebris Medical GmbH.

zebris does not accept any liability for correct function and reliability of the system if the clock signal of external devices does not comply with the signal specifications provided with in this user manual.

3.7.1 Synchronization Input (SYNC-IN)

If a third-party device is connected to the synchronization input SYNC-IN then depending on the setting of the configuration window from the application software the measurement will start/stop or “sample by sample” synchronized by a signal from the third party device.

Input is protected against faulty polarisation and pin 1 is set to +5V ("1") by an internal pull-up-resistor (2.7 kΩ). If this input is set to 0 V ("0") i.e., by a switch or break contact than the SYNC-IN is triggered.

Electrical Specifications

Input Resistance (Pull-Up 5V)	2.7 kΩ
V _{IH} (High-Level Input Voltage)	≥ 2.0 V
V _{IL} (Low-Level Input Voltage)	≤ 0.8 V
Required min. pulse time for triggering	1ms

Integrated LEMO socket in the interspace box

Series "00", three pole, coding 30°

LEMO-Part-No.: EPA.00.303.NLN



View
Socket, Front Side

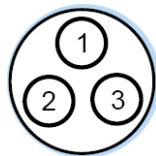

Socket Coding: 30°



Suitable Plug for SYNC-IN:

LEMO-Part-No.: FGA.00 303.CLADxxxx

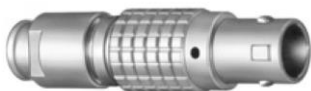

View
Plug, Solder Side



Plug Coding: 30°



Pin Assignment

Pin 1	Clk_IN
Pin 2	Activ_IN
Pin 3	GND

3.7.2 Synchronization Output (SYNC-OUT)

If a third-party device is connected to the synchronization output SYNC-OUT then depending on the setting of the configuration window of the application software, a FDM-T system controlled, will trigger a synchronized measurement of the third party device either via start/ stop or “sample by sample” mode.

Electrical Specifications

Output Resistance 100 Ω
VOH (High-Level Output Voltage) ≥ 2.0 V
VOL (Low-Level Output Voltage) ≤ 0.8 V

Integrated LEMO socket in the interspace box

Series "00", four pole, Coding 0°

LEMO-Part-No.: EPG.00.304.NLN



View
Socket, Front Side

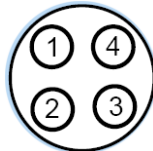

Socket Coding: 0°



Suitable Plug for SYNC-OUT

LEMO-Part-No.: FGG.00 304.CLADxxxx



View
Plug, Solder Side









Plug Coding: 0°

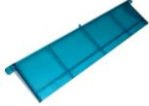

Pin-Assignment

Pin 1 +5V
Pin 2 GND
Pin 3 Activ_OUT
Pin 4 Clk_OUT

3.8 Spare Parts FDM-T System

REF	Description	Illustrations
01832035	FDM-T Interface Box 2 incl. fixation screws	
11511021	Cable protection cover for mounting on the interface box incl. fixation screws	
33102231	Power Supply MASCOT/3320 Power supply 60W / 16V DC for FDM-T sensors complies with EN 60601-1 & UL	
21030071	USB 2.0 cable A -A Data connection of measuring plate and PC Length 5 m	
07200010	zebris FDM Software for operating system Windows 7 / 64 Bit	
79010095	Hardware User Manual The print edition is subject to a charge. Availability from 5 working days after receipt of order.	
79010185	Software User Manual The print edition is subject to a charge. Availability from 5 working days after receipt of order.	

3.9 Options FDM-T Measuring System

REF	Description	Illustrations
01541000	<p>SYNCCam</p> <p>Camera with USB-Cable, synchronization cable, inclusive software extension</p>	
01541200	<p>SYNCCam HS</p> <p>Camera with USB-Cable, synchronization-cable, removable aperture, synchronisation optionally via cable or infrared, includes software extension.</p>	
01541300	<p>SYNCLightCam – Variant 30 Hz</p> <p>Combined solution with Camera and illumination, 5 m USB2.0-Cable, synchronization cable, inclusive software extension.</p>	
21030321	<p>SYNCCam/SYNCLightCam 30 Hz USB-Cable A-B</p> <p>USB2.0-Cable for HD-video signal with high quality plugs, EMC-shielding, and ferrites length 5 m</p>	
21030110	<p>USB3.0 fibre optical cable A-male/ A-female</p> <p>Extension cable between USB3.0 cable A-B 1 m and PC length 20 m</p>	
21030310	<p>Video Sync-Control Cable 5</p> <p>Length 5 m, both sides phone jack 3.5 mm</p>	
21030312	<p>Video Sync-Control Extension Cable</p> <p>Length 5 m, phone jack & socket 3.5 mm</p>	

33102232 **Power Supply Mascot/3721**
SYNCLightCam
Meets requirements of EN 60601-1 & UL



01551004 **Gait Training Type M/L/PL**
Software extension for treadmill-based gait training with step projection on the treadmill
Adjustment of the step length,
step width and angle of foot rotation
Success Report
Video projector with mounting unit,
for h/p/cosmos mercury / locomotion / pluto



01551005 **Gait Training Type Q/P/XL**
Software extension for treadmill-based gait training with step projection on the treadmill
Adjustment of the step length,
step width and angle of foot rotation
Success Report
Video projector with mounting unit,
for h/p/cosmos quasar/ pulsar/ locomotion
XL



4 Video-Module

4.1 Connection to the FDM-T System

The FDM-T system can capture data simultaneously with up to 2 video cameras. For this purpose, the **zebris SYNC**Cam is available as an accessory. Alternatively, high-quality DV-camcorders with an external microphone socket can be used for video capture.

To capture video data synchronized with pressure data the camera has to be connected to the galvanically isolated **VIDEOSYNC socket** on the interface box.



4.1.1 Connection to the zebris SYNC

The zebris **SYNC**Cam uses its integrated synchronization flash to synchronize video data with pressure data.

For connecting the SYNC

REF 21030310 Video Sync-Control Cable 5
Length 5 m, both sides phone jack 3.5 mm



4.1.2 Connection scheme SYNCLightCam

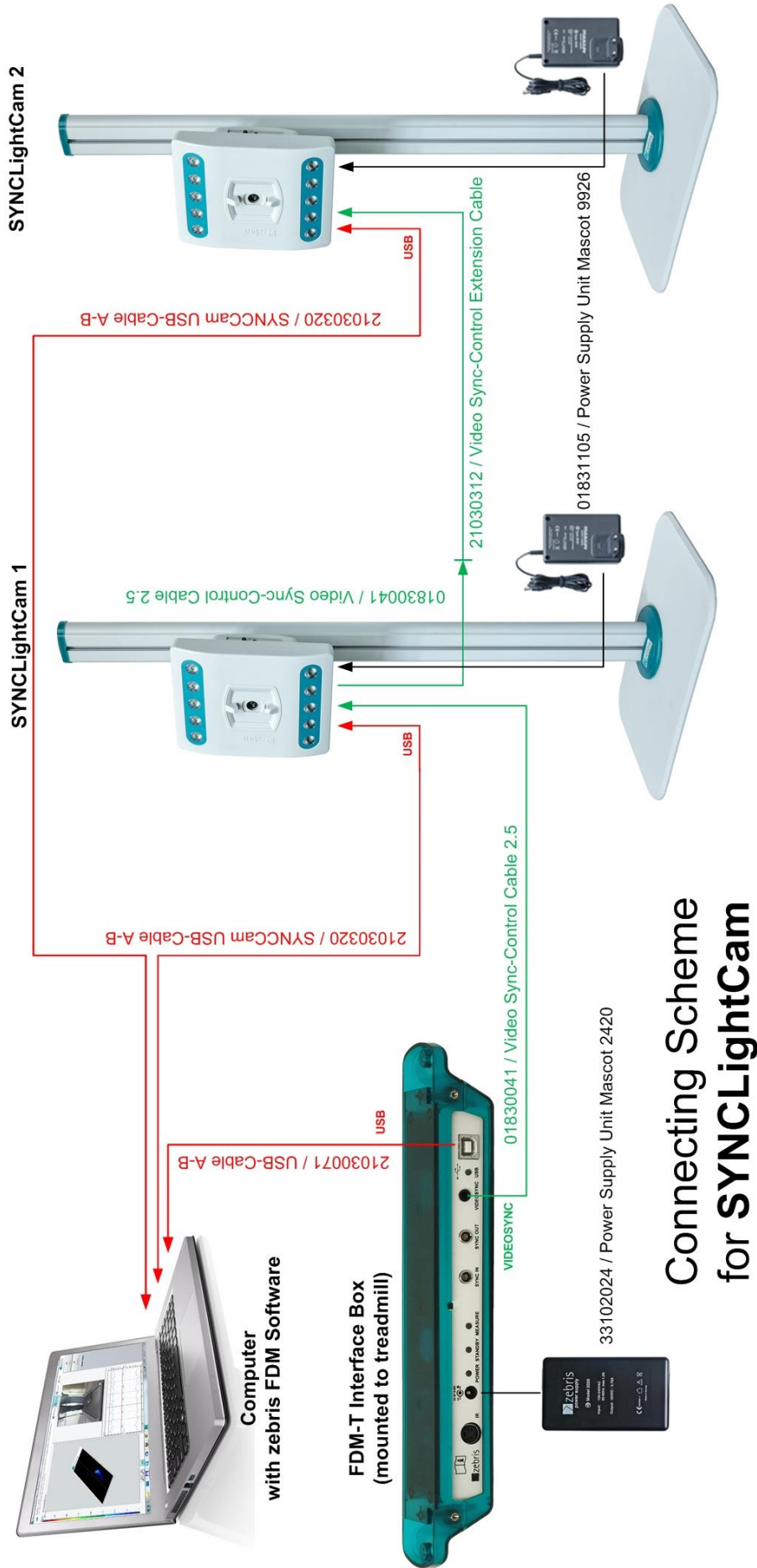

Connecting Scheme for SYNCLightCam

4.2 SYNCam

The **SYNCam** is an accessory of the FDM-T system and perfectly adapted to be used in combination with the pressure distribution measurement. All adjustments of the camera are carried out via hardware setup integrated to the zebris FDM Software. The camera is connected to the PC by a USB cable of type A-B included within the shipment.

The camera is equipped with ¼ inch tripod threads and can be adapted to zebris tripods as well as commercially available camera tripods.



The Sync-LEDs are flashing when the camera is disconnected from the USB port. Therefore, it is strongly advised not to look directly into the camera when it is disconnected to avoid dazzling.

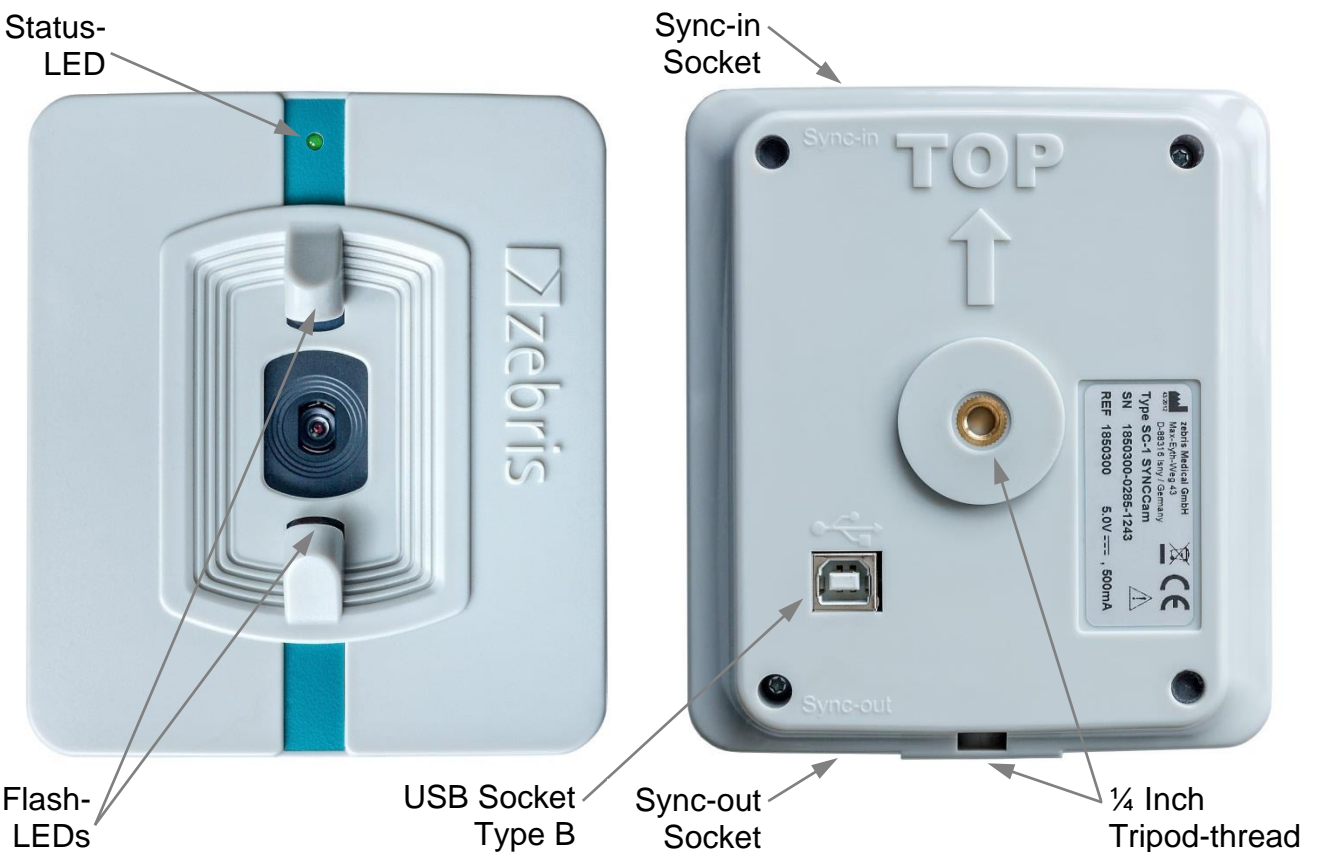

Technical Specifications

REF	0154100
Dimensions	110 x 125 x 15 mm (L x W x H)
Weight	approx. 190 g
Power Supply	USB (5 V DC / 500 mA)
Resolution	1920 x 1080 Pixel (Full-HD) / Autofocus
Frame Rate	30 Hz
Synchronization	LED-Flash triggered by Sync-IN socket
Mounting	¼ Inch tripod-thread at bottom and back side



To maintain undisturbed transmission of the video signal it is mandatory to use high quality USB cables.

Please, only use cables supplied or recommended by zebris for connecting SYNCam and PC.

4.3 SYNCCam HS

The **SYNCCam HS** is an accessory of the FDM system and perfectly adapted to be used in combination with the force distribution measurement. All adjustments of the camera are carried out via hardware setup integrated to the zebris FDM Software. The camera is connected to the PC by a USB cable of type A-C included within the shipment.

The camera is equipped with one ¼ inch tripod thread and can be adapted to zebris tripods as well as commercially available camera tripods.



The Sync-LEDs are flashing when the camera is disconnected from the USB port. Therefore, it is strongly advised not to look directly into the camera when it is disconnected to avoid dazzling.

WARNING

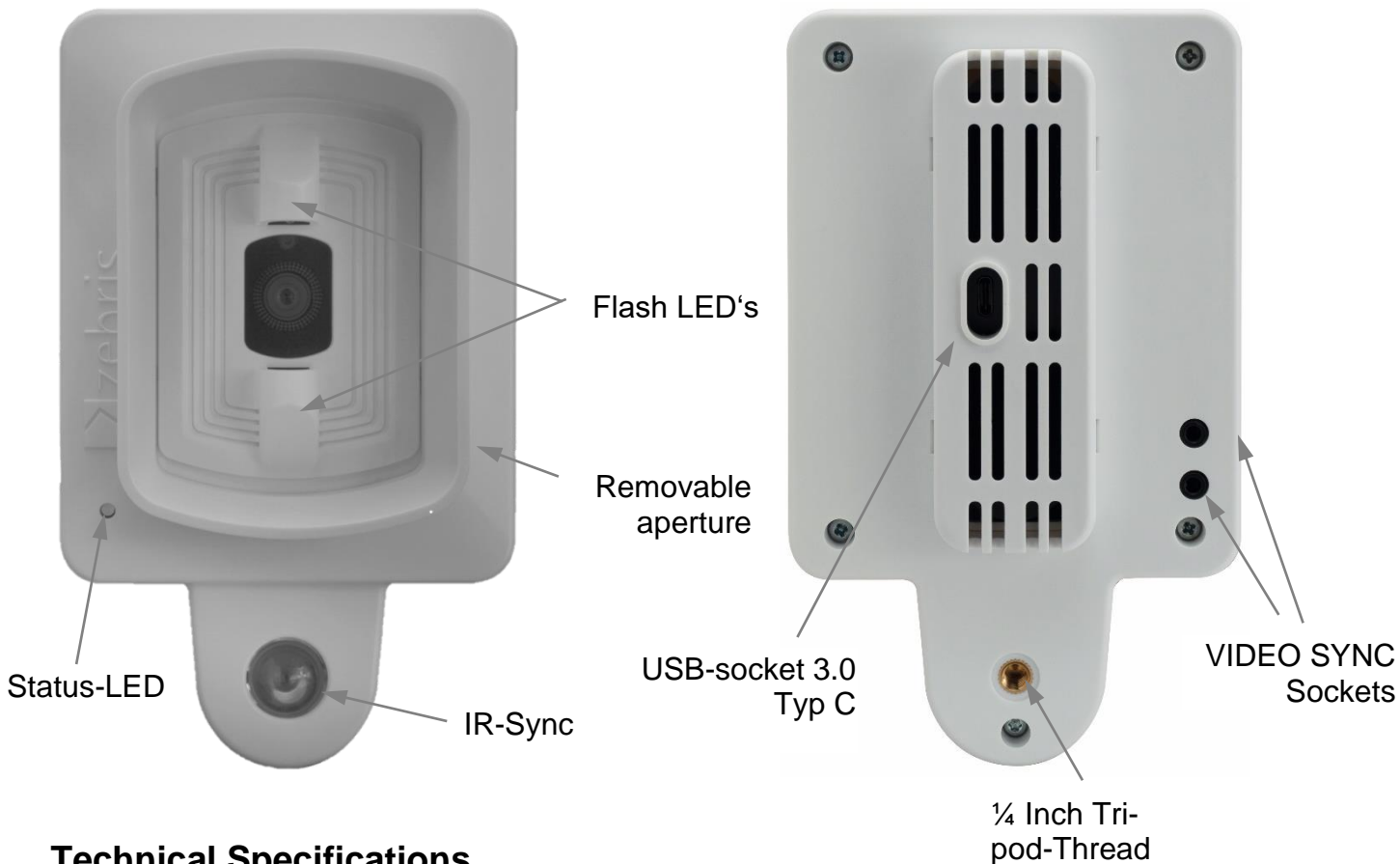

Technical Specifications

REF	01541200
Dimensions	174 x 104 x 59mm (L x H x W) – with aperture 78mm width
Weight	approx. 275g
Power Supply	USB 3.0 (5V DC / 500mA)
Resolution	max. 1920 x 1080 Pixel (Full-HD) / Autofocus
Frame Rate	max. 120Hz
Synchronization	LED-Flash triggered by Sync-IN socket or infrared
Mounting	¼ Inch tripod-thread at back side



To maintain undisturbed transmission of the video signal it is mandatory to use high quality USB cables.

Please, only use cables supplied or recommended by zebris for connecting SYNCCam and PC.

NOTE

Resolution and Frame Rate

Resolution	Frame Rate
1920 x 1080 (Full HD)	60 Hz
1280 x 720 (HD)	90 Hz
640 x 480 (VGA)	120 Hz

Synchronization Options

VIDEO SYNC Wired synchronization with special synchronization cable included in the scope of delivery

Infrared Synchronization via infrared signal without synchronization cable (not compatible with every zebris pressure plate). Cannot be used with the IR interface for zebris EMG.

Interpretation of the STATUS-LED

Green USB connected and infrared connection available

Red Only USB connected, no active infrared connection available

4.4 SYNCLightCam – Variant 30 Hz

The **SYNCLightCam** is an accessory of the FDM-T system and perfectly adapted to be used in combination with the pressure distribution measurement. All adjustments of the camera are carried out via hardware setup integrated to the zebris FDM Software. The camera is connected to the PC by a USB cable of type A-B included within the shipment.

The **SYNCLightCam** is equipped with ¼ inch tripod threads and can be adapted to zebris tripods as well as commercially available camera tripods.



WARNING

The Sync-LEDs are flashing when the camera is disconnected from the USB port. Therefore, it is strongly advised not to look directly into the camera when it is disconnected to avoid dazzling.

Furthermore, contains the SYNCLightCam as an integral solution, the LED video illumination.

To produce well lighted and tack sharp video captures it is essential to maintain perfect lighting conditions at the patient's side. Only with adequate lighting conditions video cameras can work with shutter times short enough to freeze fast movements and capture sharp images.

This solution is perfectly matched on the interaction with the FDM-T system and can be regulated infinitely in its brightness.

The integrated synchronization unit automatically switches the lights on at the start of a measurement and turns them off again after stopping it.

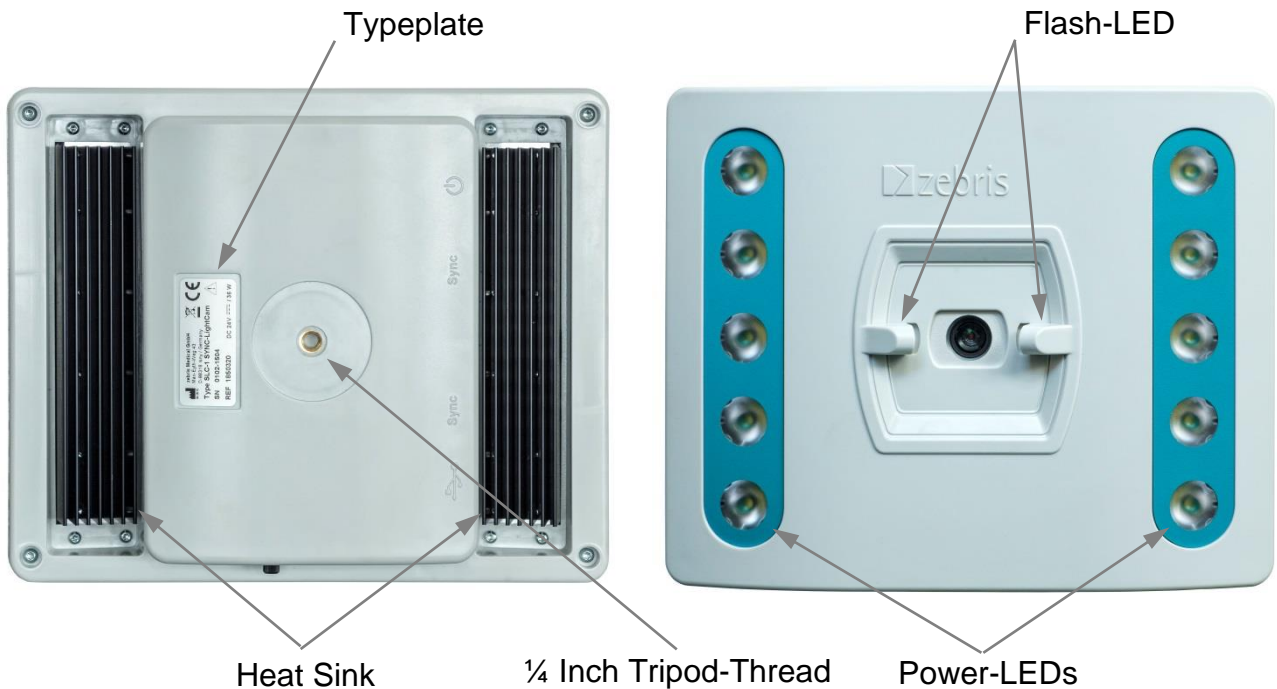

NOTE

To ensure failure-free operation of the SYNCLights it is mandatory to keep the black heat sinks at their back side uncovered and well air circulated at all times.

Technical Specifications

REF	01541300 / Variant 30 Hz
Dimensions	220 x 183 x 80mm (B x H x T)
Weight	ca. 790g
Power Supply	24V / 36W
Resolution	1920 x 1080 Pixel (Full-HD) / Autofocus
Frame Rate	30 Hz
Light Colour / Light Current	6200 K / 1550 Lumen
Light Automatic Synchronization	LED-Light switched on-/off by platform measurement LED-Flash triggered by Sync-IN socket
Mounting	¼ Inch tripod-thread at bottom and back side

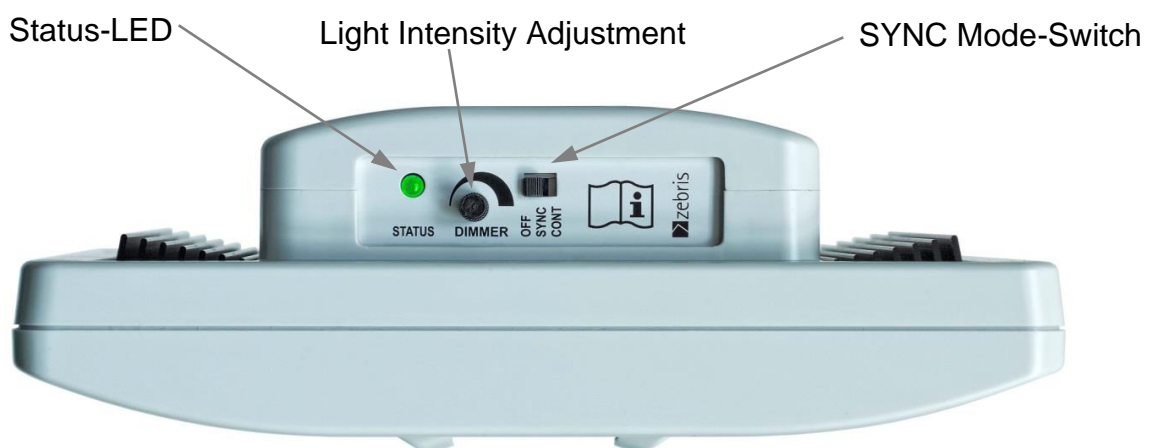

NOTE

To maintain undisturbed transmission of the video signal it is mandatory to use high quality USB cables.

Please, only use cables supplied or recommended by zebris for connecting SYNCCam and PC.

Interpretation of the STATUS-LED

- Green** Device is ready for use or in operation.
- Orange** The orange colour indicates when the maximum operation temperature has been reached. At this point the operation current is reduced automatically (which results in reduced brightness) to prevent the SYNCLight plus from being damaged by excessive heat.

Power Supply Unit

For operation of the SYNCLight plus a power supply unit needs to be connected.

REF 33102220

Input	Output	Cable	Length
100 – 240 V AC	24 V DC	DC-Lead	1.7 m
50 – 60 Hz	40 W	Mains Lead	Plug Adapter

SYNC-Modus

Modes **Characteristics**

**VIDEO
SYNC IN**

ESD - protected, voltage reversal proof input.

Input resistance: 38 k Ω (AC)
Signal-Level: AC
Trigger Level: 15 mV

Pin Assignment

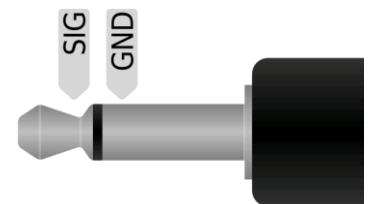

5 Gait Training Module

For the gait training and the feedback training (virtual Forestwalk) a projector unit can be mounted to the treadmill frame. To accomplish adapters individually engineered for different treadmill types are necessary. The assembly of the available adapter types is described below.



NOTE

For setup, installation and safety related instructions of the projector please refer to the user manual of the projector manufacturer.

The projector is connected directly to the corresponding hardware interface (mostly HDMI). The projection during gait training is controlled by the gait training module of the zebris FDM software.



WARNING

During long periods of operation, the projector can become very hot around the lamp and at the air outlet openings and thus should not be touched.



WARNING

To minimise the risk of falling and to prolong the lifetime of the projection lamp, the projector should only be switched on during the gait training and otherwise be switched off.



WARNING

With treadmills featuring an inverse driving direction, the projector must be separated from the mains before activating the inverse driving direction.

As with installed projector and activated inverse driving direction a higher risk of injury through falling exists because of the projector, a safety (safety bow with chest strap) should always be used with treadmills featuring an inverse driving direction.

5.1 Gait Training Type M/L/PL (h/p/cosmos mercury, locomotion, pluto)

Accessories for gait training through visual cueing with treadmill type h/p/cosmos mercury, h/p/cosmos locomotion or h/p/cosmos pluto.

Fixing the projector mount

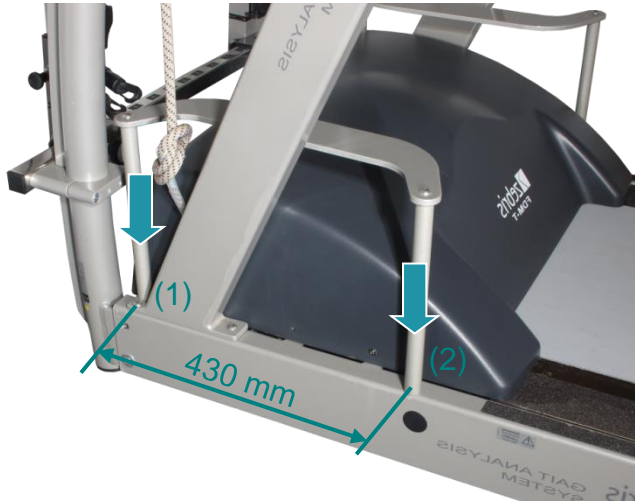

Required tools:

- Allen Key 6 mm / 8 mm
- Drill Ø 5.0 mm
- Tread Cutter M6

First remove screw (1) of the treadmill's handrail.

For attachment of the rear fixation pole a tapped hole (2) must be drilled at 430 mm from the hole in front of the handrail (1).

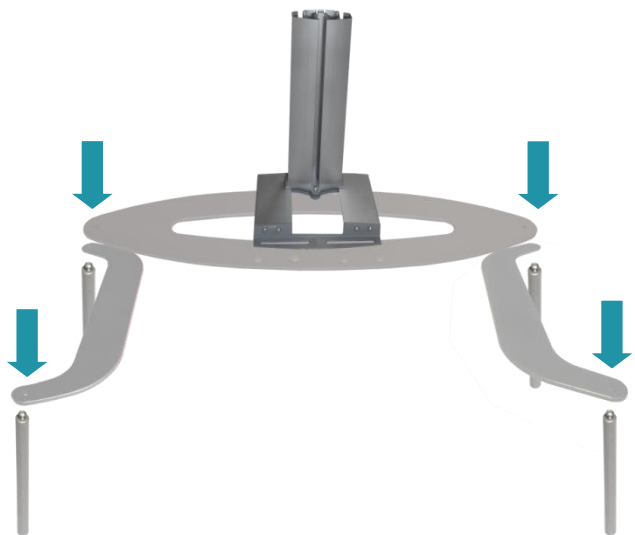

Next the components of the adapter must be assembled in the sequence illustrated left hand side.

First screw the four fixation poles to the treadmill frame and attach the C-shaped connection pieces to the poles with the screws supplied.

Then attach the oval cross member with two screws.

At last, attach the projector's stand to the cross member with the screws supplied.

For the final assembly of the projector to its stand, please refer to the user manual of the projector manufacturer.



WARNING

Please regularly check (recommended after 25 operating hours each) that all screws of the handrail and projector mount are tightly fastened.

5.2 Gait Training Type Q/P/XL and (h/p/cosmos quasar, pulsar, locomotion XL)

Accessories for gait training through visual cueing with treadmill type h/p/cosmos quasar, h/p/cosmos pulsar or h/p/cosmos locomotion XL.

Fixing the projector mount

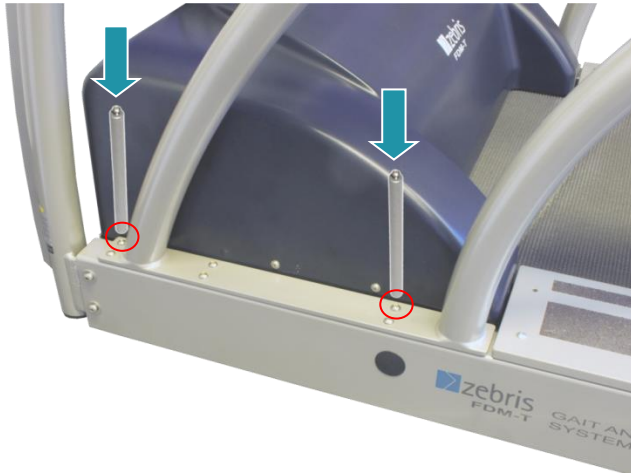

Required tools:

- Allen Key 6 mm
- Phillips Screwdriver

First remove the screws marked in red from the handrails of the treadmill.

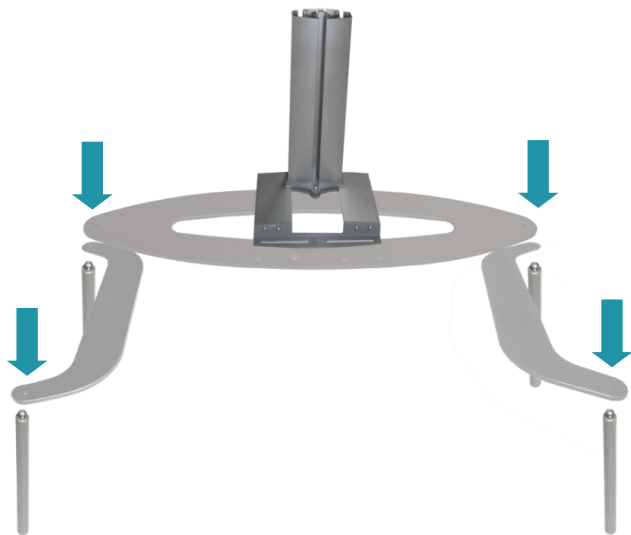

Next the components of the adapter must be assembled in the sequence illustrated on the left-hand side.

First screw the four fixations' poles to the treadmill frame and attach the C-shaped beams to the poles with the screws supplied.

Then attach the oval cross beam with two screws.

At last, attach the projector's stand to the cross beam with the screws supplied.

For the final assembly of the projector to its stand, please refer to the user manual of the projector manufacturer.



WARNING

Please regularly check (recommended after 25 operating hours each) that all screws of the handrail and projector mount are tightly fastened.

6 Setup and Operation of the FDM-T System

6.1 Positioning of the measuring system



NOTE

For setup, installation and safety related instructions of the treadmill please refer to the user manual of the treadmill manufacturer.



WARNING

A safety zone of at least 2 m in length and 1 m in width must be kept free directly behind the treadmill. No items may be left in this zone (video camera, etc.).



WARNING

It is strictly prohibited to embed the treadmill in the floor to reduce access height. This way of installation might create a highly dangerous capture area at the rear guide pulley of the treadmill. The manufacturer expressly will undertake no liability for injuries to any person when the treadmill is operated under such condition!

- Preferably place a gym mat or other padding in the safety zone behind the treadmill to soften falls.
- The floor where the device is installed must be even and horizontal.
- The belt of the treadmill must be checked after installation, or if the treadmill is moved to another place, and adjusted if required. (Please refer to the user manual of the treadmill manufacturer for this purpose.)
- Set up the measuring system such that the socket for the mains connection is always easily accessible and the device can be disconnected from the power supply.
- Once the treadmill has been installed securely and is horizontally leveled, it can be connected to a suitable mains socket and set into operation.

For the commissioning of the FDM-T system for the stance and gait analysis, the associated power supply, a USB cable type A-B as well as the installation CD with the zebris FDM application software are necessary. All components are included in the scope of delivery of the FDM-T measuring system.

All cable connections of the FDM-T sensor are integrated in the interface box, which is positioned on the underside of the treadmill frame.<

6.2 Installation of the detachable cable guard

The detachable cable guard will be attached to the interface box by means of the screws (3 x 6 mm) delivered with the measuring system as shown in the illustrations below.

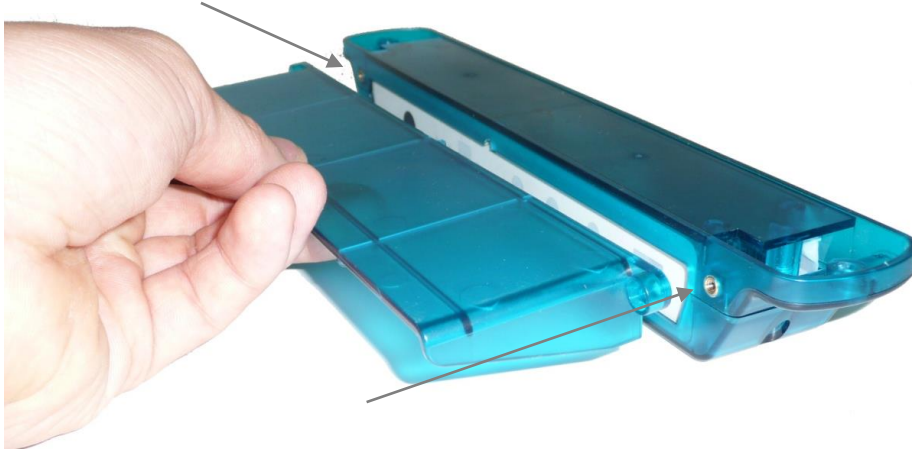

6.3 Connection of the measuring system to mains supply

6.3.1 Power supply of the FDM-T Sensors

For connecting the FDM-T sensor to the power supply, connect the power supply unit to the mains socket and the power socket on the interface box.



For operating the FDM-T sensor, exclusively use the power adapter approved by zebris, which is suitable for the power supply of all FDM-T systems.

Power Supply MASCOT/3320 REF 33102231

Technical Data

Input Voltage: 90 - 264 VAC
Mains frequency: 47 - 63 Hz
Standby 0,15 W

Pin arrangement / polarity



Before connecting the measuring system to the power supply, compare the nameplate specifications on the power supply unit and on the treadmill regarding the mains voltage and mains frequency, with the local characteristics. Connect only if they are compatible.



Before connecting or using the measuring system, carry out a visual check of the power supply unit, power supply cable and socket, as well as the earthing contacts. Damaged power supply units, cables or plug and socket devices are to be replaced immediately by an authorized person.

6.3.2 Connection of the System

For connecting the treadmill to the power supply, please additionally observe the respective instructions in the user manual provided by the treadmill manufacturer.



WARNING

The connection of the treadmill and the FDM-T power supply unit must be done at a separate wall socket. It is not permissible to use extension cables and/or multiple sockets.



WARNING

For connecting the different system components to the mains supply it is essential to stick to the following illustration exactly, to avoid the patient encountering any dangerous touch currents. For further information on this, please see Section 8.2 of this user manual. It is essential to observe the strict separation between the power supply of the system components that must be within the vicinity of the patient surroundings (treadmill incl. platform) and those that must be outside the patient's vicinity (PC, video camera, illumination).

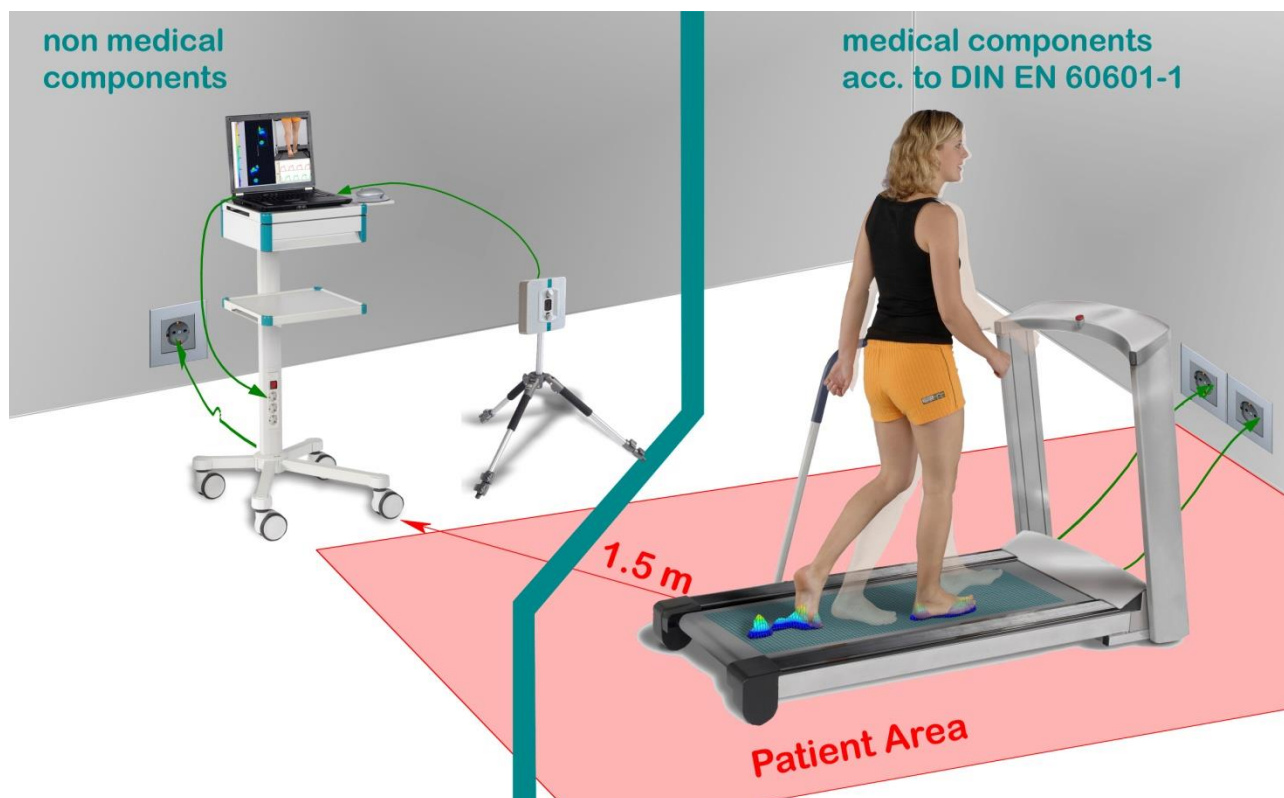

WARNING

Set all connection cables in a way that prevents patients, or persons taking part in the measuring procedure from tripping over them or damaging them mechanically. For this purpose, run the cables using cable protections or if necessary, fasten the cables with adhesive tape to the floor.

6.4 IT security and software installation

If the system is not shipped with a computer and properly installed zebris FDM software, the operator is responsible to ensure that the safety of patients, operators and environment is not compromised by the computer. If in question, please contact a dealer authorized by the manufacturer.

For the requirements of the zebris FDM Software with concern to a PC/laptop, please refer to the instructions for use of the zebris FDM Software.

To provide easy integration into an existing system for data backup and to store personal data separately from the PC the data base of the application software can be installed on a network server.

If the database of the zebris FDM software is stored on a storage medium connected via an IT network, the following requirements must be met:

- the data connection must be secured against interference by third parties,
- the data connection must be secured against disconnections,
- applicable data protection regulations must be adhered to for the data connection in the IT network as well as for the location in the IT network,
- access to the location in the IT network must be restricted to the authorized group of persons,
- the exchange of data between the zebris FDM database and the IT system is realized via the SMB protocol,
- the exchange of data with third party devices in the IT network is not provided.



If the requirements listed above are not met, the following hazardous situations may arise:

- Data loss due to disconnection during data transfer between zebris FDM software and IT network,
- Unauthorized access to personal data by third parties,
- Complete data loss due to missing data backup in the event of disruptions and / or damage to the IT network.



The manufacturer is unable to accept any liability for damage or functional errors that are caused by faulty software installation or unsuitable computer hardware. If the operator installs additional hardware or third-party software, this occurs based on the sole responsibility of the operator and is not covered by the manufacturer's liability.

The computer needs to be CE-marked and needs to satisfy the requirements of DIN EN 62368-1 and/or DIN EN 60601-1.



Connecting the system to a network/data pool can cause unforeseen risks to the patient and third parties. The zebris FDM database is not intended for simultaneous use by multiple users.

If the database of the zebris FDM software is installed in a network/data pool, the operator is obliged to ascertain, analyze, evaluate, and manage all the associated risks. In this context, the aspects of data protection, virus safety, updates to the operating system and regular backups are of particular importance. The risk assessments also have to include

the subsequent changes to the network/data pool, such as updates/upgrades to devices and components that are connected with the network.

The connection of the PC system to the Internet must take place via a professionally maintained IT network in conjunction with a hardware firewall to minimize risks due to the Internet connection. Never use the local computer with Internet access with administrator rights.



For the safe operation of the measuring system are the aspects of data protection, virus security, updates of the operating system and regular backups of the zebris FDM database on external data carriers of essential importance and to be implemented by the user as measures of IT security.

If the system is delivered without PC/laptop, please install the application software before connecting the platform to the computer. Please find information on the installation in the user manual of the zebris FDM Software.



If you encounter problems with the hardware driver of the FDM-T system, please disconnect the USB cable from the PC and restart it.



Installing a virus scanner on the PC can interfere with the proper functioning of the application software. The manufacturer is not liable for damages caused by such programs.

6.5 How to switch the FDM-T sensor On/Off

The FDM-T sensor is switched on and off by software control as soon as the zebris FDM software on the PC is started or shut down.

If the device has been connected correctly, the green power LED lights up on the interface box. For further details on preparing a measurement platform, please see the section "Recommendations for recording data".

6.6 Setting the system out of operation

To set the system out of operation, please close the zebris FDM software first, then exit the Windows operating system and shut down the PC. In the next step disconnect the power supply unit of the FDM sensor and the treadmill from mains supply.

6.7 Recommendations for recording

There are a few things one should bear in mind for obtaining significant measuring results using the FDM-T system. The following points relate to the data recording of a person while walking and describe the ideal measuring situation.

6.7.1 Treadmill Analysis

Walking on the treadmill is unfamiliar to most people and takes a certain time to get used to it. It is therefore of advantage to familiarize the test person with this new type of externally controlled movement of the treadmill before recording any data.

6.7.2 Data Recording

Also observe the test person during the measurement. Only use data recordings where the foot does not extend beyond the sensor surface during roll-off.

6.7.3 Walking Speed

The walking speed during the measurement should correspond to the person's normal walking speed. It usually takes a few minutes for the test persons to be relaxed enough for finding their normal movement pattern again. It may well be that their speed increases during the measurement. This should be avoided by carefully making sure that the test person feels at ease before the measuring begins. During the data recording the speed should not fluctuate by more than 5%.

6.7.4 Posture

The test person should adopt a relaxed posture, with the arms swinging in a natural way. Make sure that the test person looks straight ahead and not to the ground, the treadmill, or the screen, as this can influence the natural gait pattern.



Persons who are unsteady on their feet should make sure to hold onto the handrail while walking on the treadmill to avoid any danger of stumbling!

Basically, the safety features of the treadmill must be used (safety clip for emergency stop, crash bar).

6.7.5 Weals

Studies have proven that the peak plantar pressure is increased by 30 % through calluses on the foot (P.R. Cavanagh, *The Foot* (1994) 4, 123-135). This information should be taken into account during the measuring procedure.

7 Maintenance and Safety Inspections



- Scheduled maintenance of the system is essential to prevent damage and guarantees the safety of the device. All processes concerning maintenance and disinfection of the device should be carried out regularly.
- Should any malfunctions and/or defects be determined or suspected, the device must be put out of operation immediately, marked as "Out Of Service" and prevented from being used by removing the mains cable. In such case be sure to contact the manufacturer or an authorized sales partner.
- All maintenance and repair work of the measuring system or of single components that goes beyond the activities described in this user manual must exclusively be carried out by zebris Medical GmbH or a person who has been explicitly authorized by zebris to do so.
- Be sure to switch off the measuring system and disconnect it from mains supply before starting any maintenance work.

7.1 General Maintenance Procedures

- Immediate maintenance procedures are to be carried out if:
 - a) fluid enters the device.
 - b) cable or cable connections have been damaged.
 - c) covers have been damaged or have fallen off.
 - d) the running belt shows any signs of wear or cracks.
 - e) the running belt no longer runs centrally.
 - f) the sliding surface underneath the treadmill belt is no longer sufficiently lubricated.
 - g) a malfunction or a defect is suspected or has been detected.
- Check regularly (approx. every 25 operating hours) whether all the screws are tight, the belt tension is sufficient, and the running belt is correctly centered. For the exact sequence of these maintenance procedures, please refer to the user manual supplied by the treadmill manufacturer.
- To keep the friction between the running belt and the FDM-T sensor as low as possible, the system must be lubricated at regular intervals with silicone oil. zebris recommends lubricating at least every 6 months. For detailed information concerning the lubrication procedure please refer to the user manual of the treadmill manufacturer.
- Should the treadmill be relocated to another place, it is necessary to check that the belt is running correctly. The belt should always run centrally on the rear guide pulley.
- After a longer period of use, or if the adjustment is suboptimal, the belt can loosen and with every step, a jolt can occur between the drive shaft and the belt. This can possibly influence the measuring result of the system. Therefore, control the belt tension regularly in accordance with the instructions supplied by the treadmill manufacturer.
- Should you hear "mechanical knocking sounds" during operation, check whether the device is standing level on the ground as incorrectly adjusted feet may often cause knocking noises.



7.2 Mandatory periodic inspections and STK

- For maintaining the correct state of the electrical equipment, checks and technical safety inspections have to be carried out repeatedly (e.g., within Germany, acc. to BGV A3, and accident prevention regulations and technical safety tests according to the Medical Device Operating Regulations). Here it should be noted that standard regulations for electrical devices are concerned here and not measures that are specific to zebris. 
- Before each use of the measuring system, it is recommended for safety reasons to check the correct state of all the connection cables, as well as the mains cable, mains plug and mains socket. Should certain parts be damaged, they must be replaced before continuing to use the measuring system.
- Regular technical safety checks are compulsory for the treadmills. These checks may only be carried out by an authorized qualified electrician. For further information please see the user manual supplied by the treadmill manufacturer.
- For the FDM-T pressure sensors, no technical safety tests are stipulated by zebris Medical GmbH.
- If the name plate or other important labels (e.g., warning notes) are damaged or illegible they have to be replaced by the manufacturer for safety reasons.
- Each treadmill has an anti-slip area alongside the running surface on both sides. These stepping areas offer a firm hold when getting off the treadmill in emergencies. Check this anti-slip area at regular intervals and replace it immediately if it shows signs of wear.

7.3 Maintenance of the FDM-T Sensor

7.3.1 Control Procedures



WARNING

The measuring system must be checked at regular intervals to ensure its correct function and patient safety.

In case the running belt has been exposed to hard knocks or heavy items have fallen onto it, the surface of the FDM-T sensor has to be checked for damaging (cracks, dents, and scratches on the surface). If visible damages are detected, no further measurements must be carried out.

After carrying out a zero measurement, no measuring values may be shown for a condition without any load. In addition, the pressure distribution images are to be checked regularly for untypical measuring patterns. These include above all, line or column-shaped measuring patterns deviating from the surrounding values.



NOTE

To guarantee the correct functioning of the speedometer in the long term, the central position of the belt must be checked monthly according to the instructions supplied by the treadmill manufacturer, and readjusted, if required.

Whenever faults occur or in case of doubt, the manufacturer or sales partner authorized by zebris must always be contacted.

7.3.2 Calibration Procedures

The measuring accuracy of the FDM-T sensors is to be checked from time to time using a defined application of pressure.

To do so, the user can stand on the platform on one foot. Provided that he knows his body-weight, the platform must then show the approximate body weight, taking the force of gravity, the sensors at the edges that may not be under full pressure, and the measuring tolerance into consideration.

In case the measuring results show deviations larger than $> \pm 5 \%$ of the full measuring range, a recalibration by the technical service of zebris Medical is required.

If any doubt exists about the measuring accuracy of the FDM-T sensor, it is recommended to have the pressure distribution measuring sensors checked and re-calibrated by zebris, to ensure the specified measuring accuracy.



NOTE

On request, service instructions for the assembly and disassembly of the FDM-T sensor can be supplied for various treadmill types, so that maintenance and repair work can be carried out by trained personnel on site.

7.4 Troubleshooting

In the case of faults, please check the following points first:

- ✓ Are the FDM-T sensor and treadmill connected correctly to the mains? (Green Power LED on the interface box and power switch on the treadmill lights up.)
- ✓ Is the USB connection between the interface box and the measuring PC correct? (Green USB LED lights up when the USB is connected to the PC and the device driver is correctly installed.)
- ✓ Are all the other components of the measuring system (infrared synchronization with zebris DAB Bluetooth, video camera) connected correctly?



NOTE

For additional information on error messages and their troubleshooting, please refer to the user manual for the zebris FDM software.

Check list for noting down error messages:



NOTE

To provide best possible support in the event of system malfunctions our service personnel will need the following information:

- ✓ Device type + serial no. of the FDM-T sensor and treadmill
The serial no. can be found on the type plates on the frame of the treadmill or on the back of the interface box.
- ✓ Version of the zebris FDM Software
- ✓ Data on the operating system of your measuring PC
e.g., Windows 7 Service Pack 1
(can be found under Start >> Properties>> Control Panel>> System)
- ✓ Further components connected to the measuring system
e.g., infrared synchronization (IR) with zebris DAB Bluetooth, video camera
- ✓ List of all the USB devices connected to the measuring PC
e.g., mouse, printer, other measuring systems, etc.
- ✓ Screenshot of the error message or exact wording
e.g., "EMG adapter not found."
- ✓ User's procedure leading to the error message
e.g., measurement "Type A" started, then clicked on button "B", then movement "C" carried out, switch-over to function "D", when switching back the described error message occurred.

7.5 Cleaning and disinfection

7.5.1 Cleaning Procedure

The treadmill and components are cleaned with a moist cloth while the device is switched off and the mains plug taken out.



NOTE

Do not use any aggressive agents to clean the measuring system.



WARNING

Please make sure to switch off the device and pull the mains plug out of the socket before you commence disinfecting and cleaning.

7.5.2 Disinfection Procedure

The treadmill can be disinfected by wiping over with suitable detergents. Best wipe the running belt or other parts of the treadmill with a cloth soaked with disinfection liquid. To remove more resistant contamination directly spray the running belt with disinfection liquid.

Recommended disinfection agent:

Composition approx. 25% ethanol, 35% propanol

E.g., Mikrozid Liquid / Schülke & Mayr or similar solutions



NOTE

If you apply disinfectant be sure to strictly follow the recommendations provided by the manufacturer of the disinfectant. Especially consider the rules concerning the disinfectant's recommended duration of impact.



WARNING

On no account bring any disinfection fluids or other liquids in direct contact with the FDM-T sensor when cleaning.

Should any liquid enter the platform it is likely to be damaged irreparably.



WARNING

Fluids required for disinfecting and cleaning must be stored, prepared, and kept ready for use exclusively in the containers provided, to avoid them being mistaken for other fluids.



NOTE

For confirmation that disinfection has been carried out, it is advised to place a visible sign on the running surface reading "disinfected".

7.6 Disposal

7.6.1 Packaging

All the transport packaging supplied by zebris can be recycled within Germany via the local recycling depots. To guarantee the re-use of the recyclables contained in the packaging, zebris Medical GmbH participates in the Dual System ZENTEK which takes over the proper disposal of the packaging.



Please find information concerning the disposal of the treadmill in the Operating Instructions supplied by the treadmill manufacturer.

7.6.2 WEEE-Directive

This symbol indicates that according to the directive on waste electrical and electronic equipment (2012/19/EEC) the product must not be disposed by means of the domestic waste system. Within Europe this device must be forwarded to a specific waste disposal system.

For this purpose, the measuring system can be returned to zebris Medical GmbH at the end of its service life at the customer's own expense and will be forwarded to special recycling companies without any further costs and refund.

The improper use of old devices (measuring systems) could lead to negative effects for the environment and the public health because of potential hazardous materials which are frequently contained within electric and electronic devices. Additionally, with the proper disposal of this product you will contribute to the effective use of natural resources.

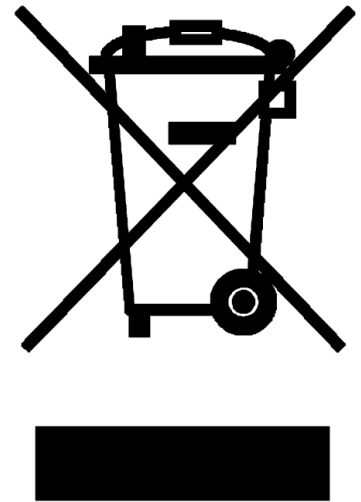

7.6.3 Accumulators and batteries

Accumulators and batteries must not be disposed of with domestic waste! In the interest of environmental protection, the consumer is legally obliged (battery regulation) to return old and used batteries. Used accumulators and batteries can be disposed of at the collecting points of the community or where batteries of the relevant kind are sold. For consumers, the batteries are taken back free of charge.

8 Safety standards and classification of the system

The following information and warnings are based on requirements of the Standard EN 60601-1, Section 16 for Medical Electrical Equipment and for the application of the FDM-T system for medical purposes.



NOTE

The sections 8.1 – 8.3 are only applicable for the FDM-T sensor integrated in the treadmill and the components listed in this User Manual. Please find information concerning the disposal of the treadmill in the Operating Instructions of the treadmill manufacturer.

8.1 Classification acc. to Annex IX of Directive 93/42/EEC

The system is then classified as medical product **Class I with measuring function**.

8.2 Safety of medical electrical device

The system meets the requirements of the standards EN 60601-1

Classification according to EN 60601-1

Type BF

Safety class II

Steady state conditions

Unsuitable for use in an oxygen-enriched atmosphere

8.2.1 Coupling of the FDM-T measuring system with other electrical devices

(refer to EN 60601-1 Par. 16 Medical electrical equipment)



WARNING

The FDM-T System may only be coupled with other electrical devices if these conform to the provisions of EN 62368-1 or EN 60601-1 or zebris Medical GmbH has confirmed their compatibility.



WARNING

When coupling several devices to a measuring system, care must be taken to avoid any danger arising from the summation of the leakage currents.

In the case of devices that the patient comes into direct contact with, and that are used together in one medical, electrical system, they must adhere to the requirements of EN 60601-1 Section 16.

There is a danger of an electric shock if devices are touched that have not been connected to ground separately.

8.2.2 Vicinity of the patient / test person

In practice 1.5 m surrounding the patient has been approved sufficient for defining the patient's vicinity. Within this distance only medical electrical equipment proved to be in accordance with EN 60601-1 is allowed to be used.

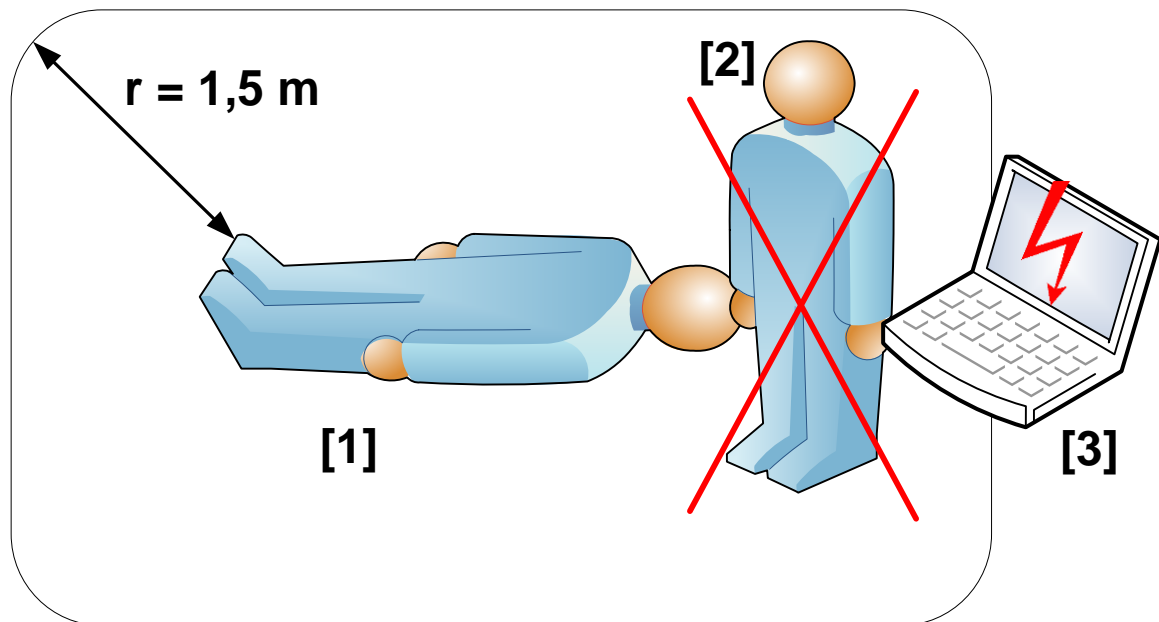

WARNING

When operating the system, the user [2] must ensure that he does not touch the PC [3] and the patient [1] at the same time. The same applies for all other non-medical, electrical components; they may only be used outside the patient's vicinity.

Furthermore, the user must ensure, never to touch the contacts of the connectors of the interface box and the patient at the same time.

In case of non-observance, dangerous leakage currents can occur.

The following components of the FDM-T system may be used in the vicinity of the patient:

- Treadmill (medical version)
- FDM-T sensor (integrated in the treadmill)



WARNING

The computer and other non-medical electrical equipment (e.g., camera equipment, lights) must be located beyond the reach of the patients (1.5 m).

8.2.3 Use of multiple sockets

The following information and warnings are based on the requirements of the Standard EN 60601-1, Section 16 for medical electrical equipment and must be enforced when the FDM-T system is used for medical purposes.



WARNING

If multiple sockets are used for connecting the FDM-T system or its components, the following safety regulations are to be observed:

- Always connect the treadmill and FDM-T sensor directly to mains supply by using a separate wall socket with a tested protective earth conductor and separate fuse.
- Multiple sockets can be used without causing any danger for connecting the PC and other electrical devices (video camera, illumination) outside the patients' vicinity.
- Multiple sockets must not be placed on the floor to avoid accidentally penetration of liquids or mechanical damages.
- It is forbidden to use extension cables, or several multiple sockets connected in series.
- In commercially available multiple sockets, system components set up within and outside the vicinity of the patient must never be plugged in together. (Example: It is forbidden to connect the PC and the power supply unit of the FDM-T sensors to the same multiple sockets.)
- If multiple sockets are used jointly for components of the FDM-T system, that can be located within the vicinity of the patient (e.g., treadmill, FDM-T sensor or other zebris measuring systems) and components that have to be outside the vicinity of the patient (e.g., PC, video camera), the multiple socket and complete interconnection of the system must adhere to all the requirements of EN 60601-1 Section 16. If necessary, an isolating transformer is to be used for an arrangement of this kind, and the ground leakage current in the protective earth conductor of the multiple sockets must not exceed 5 mA. The adherence to the maximum permissible patient leakage currents is to be verified by measuring. If a multiple socket was integrated after setting the system into operation for the first time, no additional device may be connected to it (use multiple sockets with locking covers for this purpose)



WARNING

It is extremely dangerous to use multiple sockets for combining the mains connection of components of Medical Electrical Equipment Systems with other components that have not been supplied at the same time.

It is possible for excessive touch currents to occur if mains are connected without the user having any respective expert knowledge.

Due to these complications zebris Medical GmbH urgently advises not to use multiple sockets for operation of the system.

8.3 Electromagnetic Compatibility / Manufacturer's Declaration

The measuring system FDM-T fulfills all requirements for EN 60601-1-2.

Detailed information on EMC values and information supplied by the manufacturer can be found in the tables in this section of the user manual.

Electrical equipment in the medical field is subject to precautionary measures as regards the EMC (Electromagnetic Compatibility) and must be installed and put into operation in accordance with the instructions given below.



WARNING

Even though the motion analysis system FDM-T fully complies with the requirements of the standard EN 60601-1 it cannot be totally accepted that portable and mobile RF communications equipment can affect the system. If ever possible such devices should not be operated within the system environment during measurements.



WARNING

The use of accessories, particularly cables for connecting to the PC, that are not supplied by zebris for use with the FDM-T system, or explicitly recommended for use with the device, can lead to a reduced resistance to EMC interference of the FDM-T system.



WARNING

The FDM-T measuring system should not be operated in the vicinity of e.g., X-ray equipment, motors, or transformers with a high connected load, as electrical or magnetic interference fields can influence the measurements. The same is applicable for neighboring power lines and equipment without a CE mark. Should operation next to possible sources of interferences be necessary it is mandatory to check and verify the correct function of the system.



NOTE

In the case of over voltages or voltage dips (even short-term) of more than 50% of the mains voltage, functional faults can occur. When such high voltage dips or complete voltage failures occur, the measurement is interrupted, and the measuring data is discarded. Finally, the measurement must be re-started, and if need be, also the connected PC.

Guidelines and Manufacturer's Statement - Electromagnetic Emission

The FDM-T pressure-distribution measuring system is intended for use in the electromagnetic environment described below. The customer or user of the FDM-T pressure -distribution measuring system should ensure that it is operated in such an environment.

Emitted interference measurements	Compliance	Electromagnetic environment guidelines
RF emissions acc. to CISPR 11	Group 1	The FDM-T pressure -distribution measuring system uses RF energy exclusively for its internal functions. Therefore, its RF emission is very low, and it is unlikely that electronic equipment in close proximity will experience interference.
RF emissions acc. to CISPR 11	class B	The FDM-T pressure -distribution measuring system is intended for use in all facilities including those in residential areas and those directly connected to a public utility network also supplying buildings used for residential purposes.
Emission of harmonic oscillations acc. to IEC 61000-3-2	class B	
Emission of voltage fluctuations / flickers acc. to IEC61000-3-3	in compliance	

Guidelines and Manufacturer's Statement - Electromagnetic Interference Immunity

The FDM-T pressure -distribution measuring system is intended for use in the electromagnetic environment described below. The customer or user of the FDM-T pressure -distribution measuring system should ensure that it is operated in such an environment.

Interference immunity tests	IEC 60601 test levels	Compliance level	Electromagnetic environment guidelines
Electrostatic discharge (ESD) acc. to IEC 61000-4-2	± 6 kV contact discharge ± 8 kV atmospheric discharge	± 6 kV contact discharge ± 8 kV atmospheric discharge	Flooring should be of wood or concrete or laid with ceramic tiles. If the flooring is made of synthetic material, the relative humidity must be at least 30%.
Fast transient electrical interferences/bursts acc. to IEC 61000-4-4	± 2 kV for power lines ± 1 kV for input and output lines	± 2 kV for power lines ± 1 kV for input and output lines	The quality of the supply voltage should be the same as the voltage of a typical business or hospital environment.
Surges acc. to IEC 61000-4-5	± 1 kV differential mode voltage ± 2 kV common mode voltage	± 1 kV differential mode voltage ± 2 kV common mode voltage	The quality of the supply voltage should be the same as the voltage of a typical business or hospital environment.
Blackouts, brownouts and fluctuations of the power supply acc. to IEC 61000-4-11	< 5% U_T (> 95% crash of the U_T) for ½ period 40% U_T (60% crash of the U_T) for 5 periods 70% U_T (30% crash of the U_T) for 25 periods < 5% U_T (> 95% crash of the U_T) for 5 s	< 5% U_T (> 95% crash of the U_T) for ½ period 40% U_T (60% crash of the U_T) for 5 periods 70% U_T (30% crash of the U_T) for 25 periods < 5% U_T (> 95% crash of the U_T) for 5 s	The quality of the supply voltage should be the same as the voltage of a typical business or hospital environment. If the user of the FDM-T pressure-distribution measuring system requires the continuation of functionality also after power interruptions/disruptions, it is recommended to provide the FDM-T pressure-distribution measuring system with power from an uninterruptible power supply.
Magnetic field with supply frequency (50/60 Hz) acc. to IEC 61000-4-8	3 A/m	Not tested as no influence is possible on the device within the specified test level. (see Note B)	Magnetic fields of the mains power frequency should comply with the typical values of a business and hospital environment.

NOTE U_T is the AC main voltage prior to applying the test levels.

Guidelines and Manufacturer's Statement - Electromagnetic Interference Immunity

The FDM-T pressure -distribution measuring system is intended for use in the electromagnetic environment described below. The customer or user of the FDM-T pressure -distribution measuring system should ensure that it is operated in such an environment.

Interference immunity tests	IEC 60601 test levels	Compliance level	Electromagnetic environment guidelines
			Portable and mobile wireless sets should not be used in closer proximity to the FDM-T pressure -distribution measuring system, including the cables, than the recommended safety distance, that is calculated on the basis of the formula suitable for the transmitting frequency. Recommended safety distance:
Conducted RF interference quantities acc. to IEC 61000-4-6	3 V _{eff} 150 kHz to 80 MHz	3 V _{eff}	$d = 1.2\sqrt{P}$
Radiated RF interference quantities acc. to IEC 61000-4-3	3 V/m 80 MHz to 2.5 GHz	3 V/m	$d = 1.2\sqrt{P}$ 80 MHz to 800 MHz
			$d = 2.3\sqrt{P}$ 800 MHz to 2.5 GHz
			With <i>P</i> as the rated output of the transmitter in watts (W) according to the information provided by the manufacturer of the transmitter and <i>d</i> as the recommended safety distance in meters (m). The field strength from fixed RF transmitters as determined by an electromagnetic site survey ^a is less than the compliance level ^b in all the frequencies. Interference is possible in the proximity of devices featuring the following pictograph
NOTE 1	The higher value applies in the case of 80 MHz and 800 MHz.		
NOTE 2	These guidelines may not be applicable in all situations. The spread of electromagnetic waves is influenced by absorption and the reflections of buildings, objects, and people		
a	The field strength of stationary transmitters, such as the base stations of mobile phones and land mobile services, ham radio stations, AM and FM radio and TV broadcasters is theoretically not 100% predictable. A site study is recommended to determine the electromagnetic environment because of stationary RF transmitters. If the measured field strength at the site of the FDM-T pressure distribution measuring system exceeds the compliance levels listed above, the FDM-T pressure distribution measuring system must be monitored to document its proper functionality at every place of application. Additional measures might become necessary, e.g., modifying the orientation or moving the location of the FDM-T pressure -distribution measuring system, if unusual performance characteristics are observed.		
b	The field strength is less than 3 V/m for the frequency range of 150 kHz to 80 MHz		

Recommended Safety Distances between Portable and Mobile RF Telecommunications Devices and the FDM-T/FDM-T pressure-distribution measuring system

The FDM-T pressure -distribution measuring system is intended for use in an electromagnetic environment where RF interference quantities are controlled. The customer or user of the FDM-T pressure -distribution measuring system can contribute towards preventing electromagnetic emissions by complying with the minimum distance between portable and mobile RF telecommunications devices (transmitters) and the FDM-T pressure -distribution measuring system, as recommended below in accordance with the maximum output power of the communication device.

Rated output of the transmitter (W)	Safety distance based on the transmitting frequency (m)		
	150 kHz to 80 MHz $d = 1.2\sqrt{P}$	80 MHz to 800 MHz $d = 1.2\sqrt{P}$	800 MHz to 2.5 GHz $d = 2.3\sqrt{P}$
0.01	0.12	0.12	0.23
0.1	0.38	0.38	0.73
1	1.2	1.2	2.3
10	3.8	3.8	7.3
100	12	12	23

The safety distance for transmitters with a rated output not listed in the table above, can be calculated by applying the formula corresponding to the respective column, whereby *P* is the rated output of the transmitter in watts (W) as specified by the transmitter manufacturer.

NOTE 1 For calculating the recommended safety distance of transmitters in the frequency range of 80 MHz to 2.5 GHz, an additional factor of 10/3 was used to reduce the probability of a mobile/portable telecommunications device taken unintentionally into the patient's area, causing interference.

NOTE 2 These guidelines may not be applicable in all situations. The spread of electromagnetic waves is influenced by absorption and the reflections of buildings, objects, and people.